

# Assembly Instructions

**Caution : You must read this before you proceed**

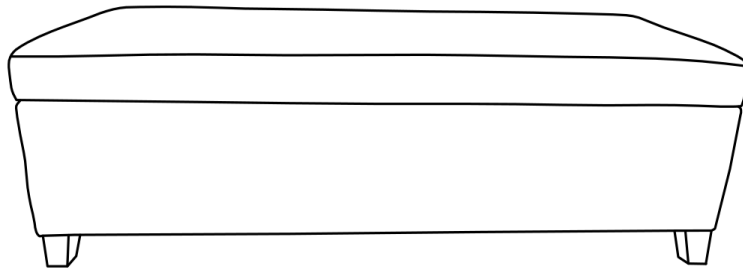

## **Ottoman**

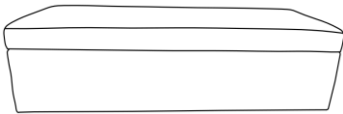
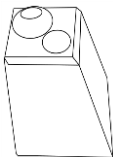

### Parts List

Label	Picture	Description	QTY
A		Storage Ottoman	1
B		Wooden Legs (Pre-installed studs)	4

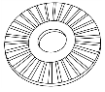
### Hardware

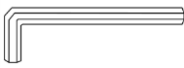
Label	Picture	Description	QTY
①		Washer Rings	5
②		Bolt M8X85mm	5
③		Allen Key	1

# Assembly Preparation

Before Beginning Assembly:

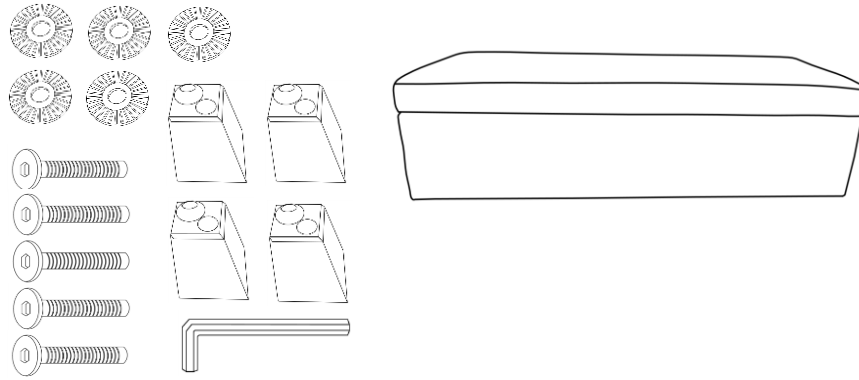

- Read instructions, cover to cover-



- Have 2 adults on hand for assembly-



- Do not assemble on flooring or carpet-



- Assemble on a clean non-marring surface (packing foam)-



- Save all packaging until finished-

# Assembly Steps

## Overview

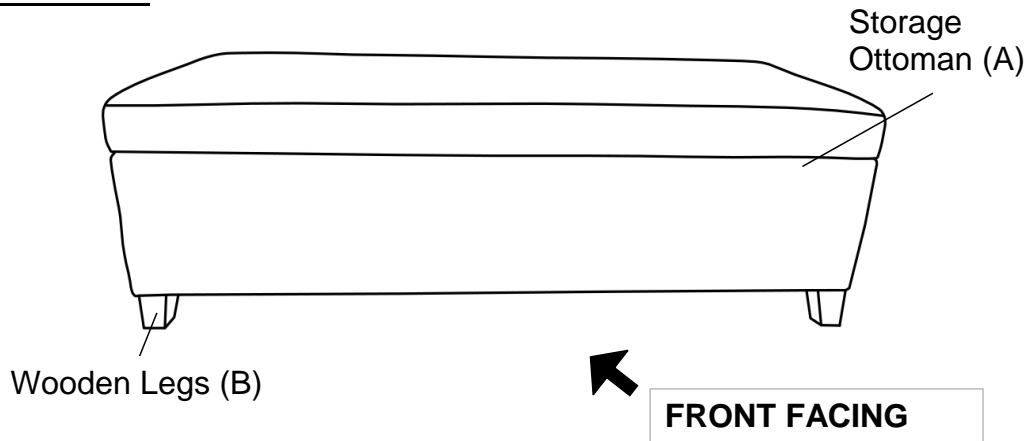

This Ottoman has multiple parts and may require up to 30 minutes to assemble. To give you an overview of the Ottoman parts, the above picture is to help you put the various parts into perspective. Please read through the instructions herebelow to familiarise the parts and steps before assembly.

## Step 1

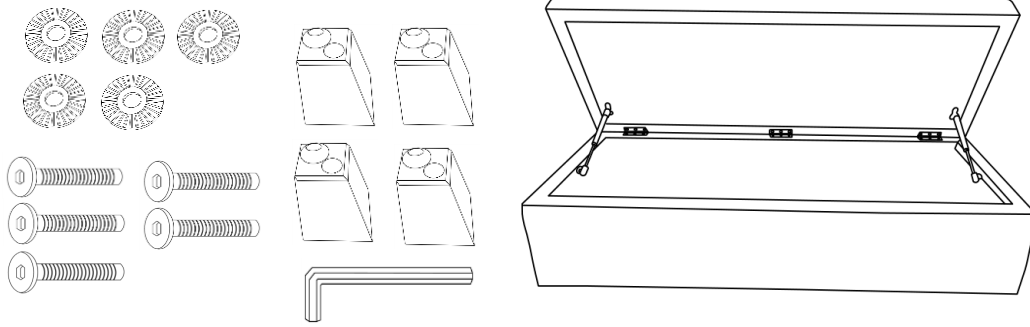

Open up the Storage Ottoman and take out the bag with the parts.  
Retrieve the Casters and Wrench.  
Place the components on a clean soft surface.

## Step 2

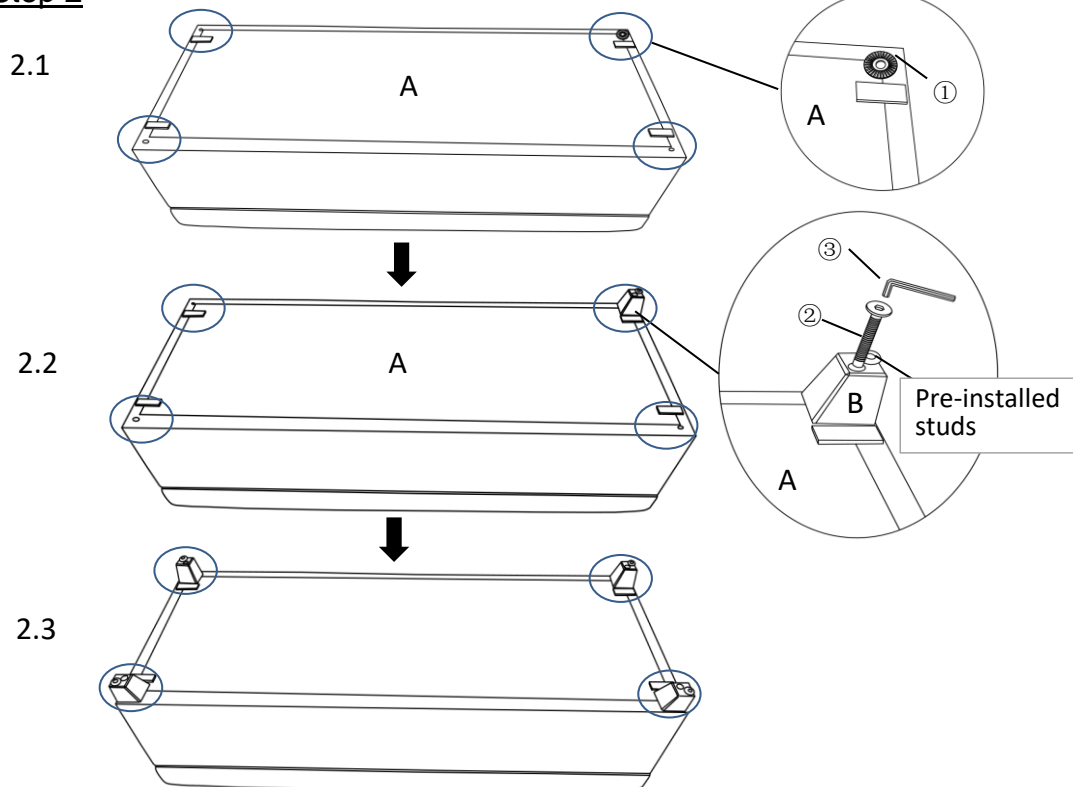

### Step2.1

Place the washer ring (①) on top of the Storage Ottoman(A), as shown

### Step2.2

Align the mounting positions on the Wooden Legs(B) to those on the underside of the Storage Ottoman(A).

Attach one Wooden Leg(B) to the Storage Ottoman(A) using one Bolt(②) and the Allen Key(③).

**Note: The pre-installed studs on the feet should face outwards**

### Step2.3





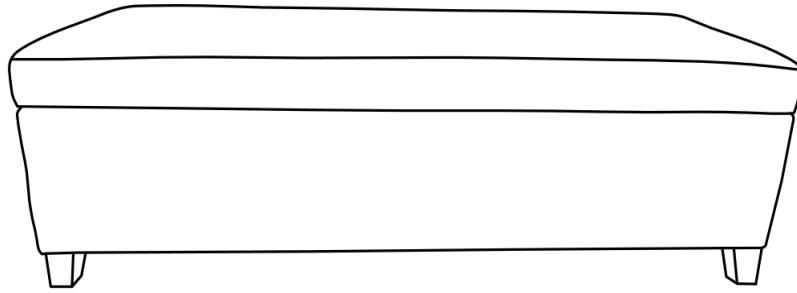





Repeat the same installation process for the remaining three wooden legs

**Step 3**



Place the Storage Ottoman right side up and it is ready for use.  
This Ottoman can only be used on a flat, level surface.

## **Care & Maintenance**

-  Do not put hot items directly on furniture surface.
-  Do not clean furniture with harsh cleansers or polish.
-  Do not place furniture under direct sunlight.
-  Do not place furniture near heating or cooling vents.
-  Do not write on furniture without a padded barrier to protect the surface.
-  Do not place furniture outside . For indoor use only .
-  Not for commercial use. For residential use only .
-  Stains may be removed with mild soap solution and damp cloth.
-  Children should not climb or jump on the furniture.
-  Dust and pick-up spills using a clean, non-colored, lint-free cloth