

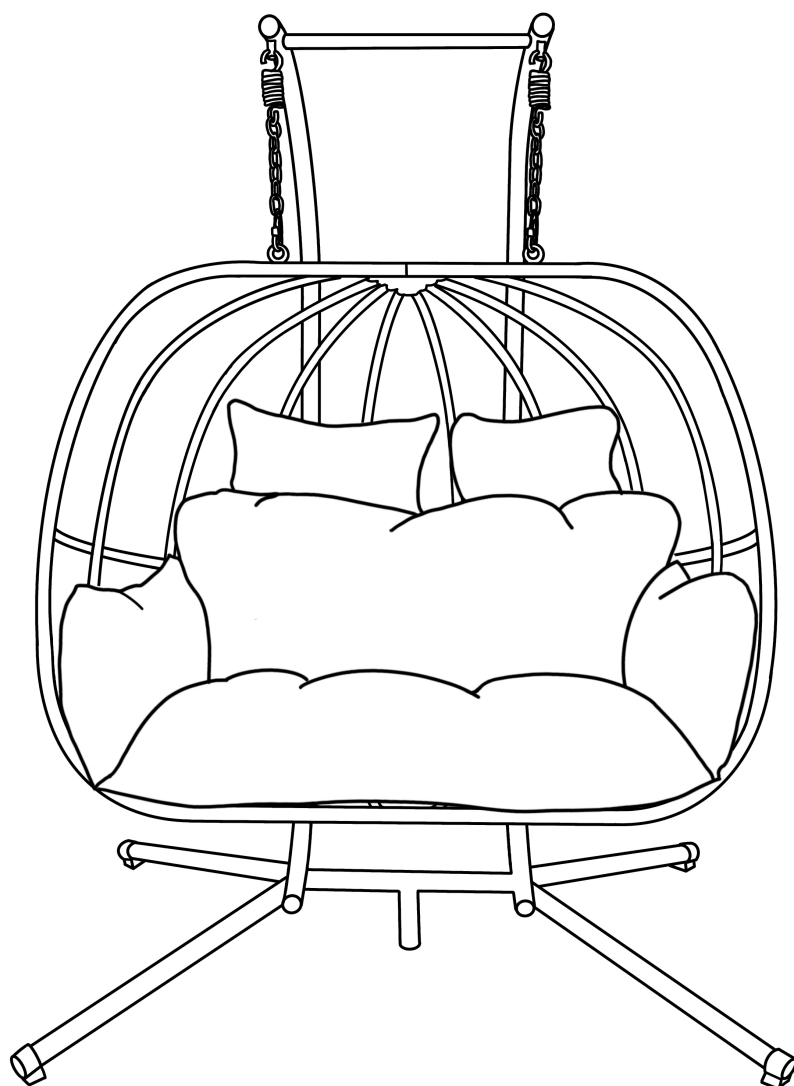

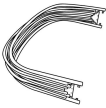







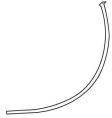

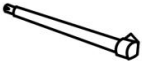
ASSEMBLY INSTRUCTION















Hammock Swing

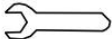
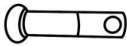
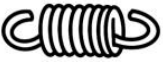

Parts List

| LABEL | | DESCRIPTION | QTY |
|-------|---|---------------------------------|-----|
| A |  | Swing Basket | 1 |
| B |  | Basket Support Leg Right | 1 |
| C |  | Basket Support Leg Left | 1 |
| D |  | Suspension Rod | 2 |
| E |  | Leg | 4 |
| F |  | Base Support Leg Right | 1 |
| G |  | Base Support Leg Left | 1 |
| H |  | Base Leg Connector | 1 |
| I |  | Suspension Rod Connector | 2 |
| J |  | Basket Support Leg Connector | 2 |
| K |  | Pillow | 2 |
| L |  | Cushion | 1 |
| | | | |

Hardware List

| LABEL | | DESCRIPTION | QTY |
|-------|---|----------------------------|----------------|
| #1 |  | Bolts M6 x 15 mm | +1 Spare 12 |
| #2 |  | Bolts M6 x 25 mm | +1 Spare 2 |
| #3 |  | Bolts M6 x 40 mm | +1 Spare 8 |
| #4 |  | Bolts M8 x 55 mm | 4 |
| #5 |  | Hanger Bolt M10 x 60 mm | 2 |
| #6 |  | Flat Washer M6 | +2 Spare 36 |
| #7 |  | Flat Washer M8 | 4 |
| #8 |  | Nut M6*10mm | +1 Spare 14 |
| #9 |  | Nut M10*15 mm | 4 |
| #10 |  | Allen Wrench M4 | 1 |
| #11 |  | Wrench 10*10 | 1 |
| #12 |  | Wrench 15*15 | 2 |
| #13 |  | Round Cap Bar | 2 |
| #14 |  | Hook Spring | 2 |
| #15 |  | Chain | 2 |
| #16 |  | Carabiner | 2 |
| #17 |  | Safety Belt | 2 |

1

#2 x2PCS



M6*25mm

#6 x4PCS



M6

#8 x2PCS



Nut M6



#10&11

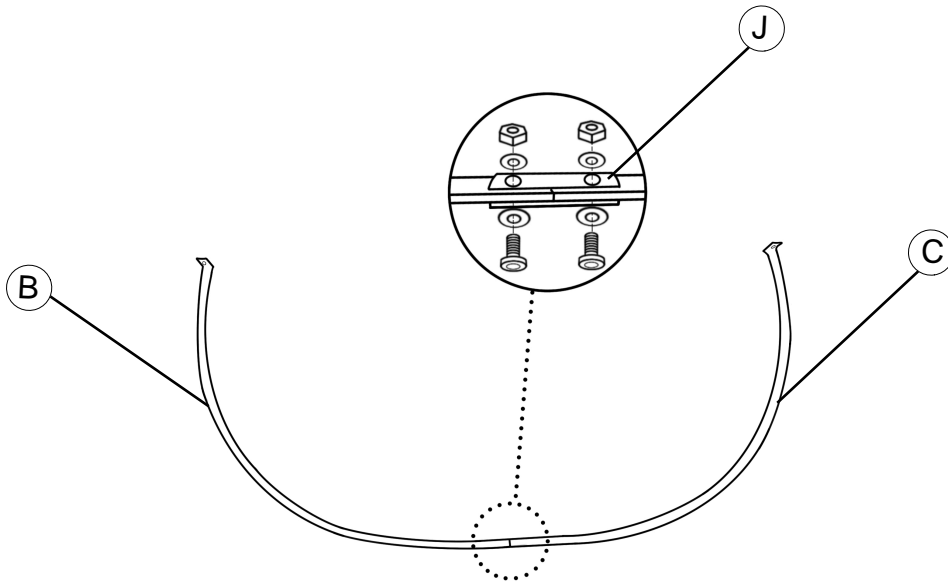

2

#1 x4PCS



M6*15mm

#6 x8PCS



M6

#8 x4PCS



Nut M6



#10&11

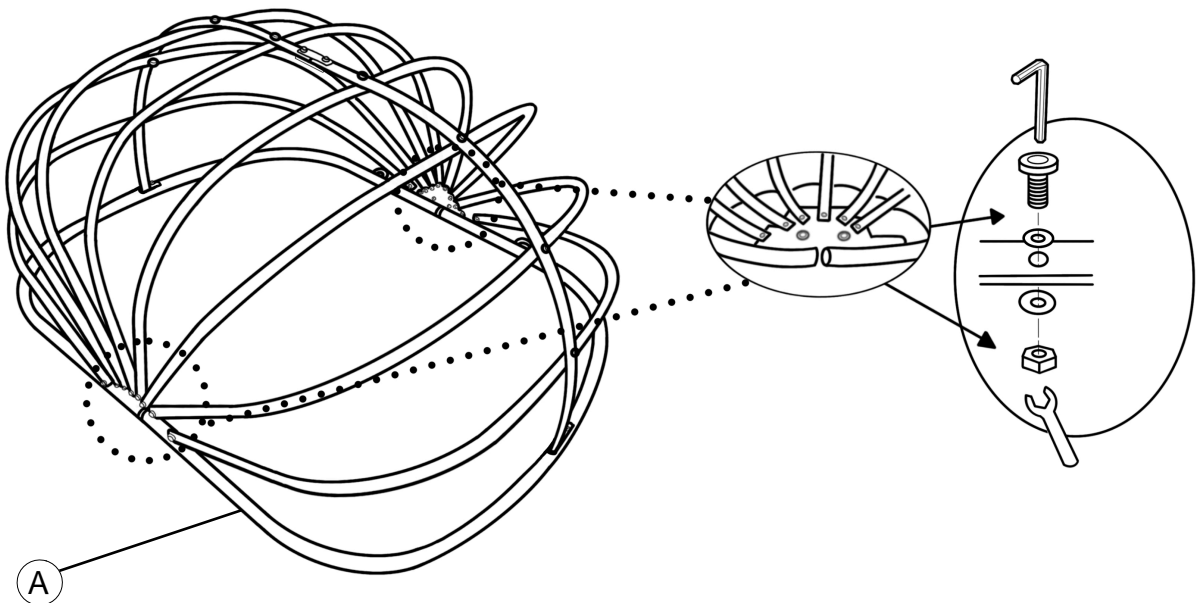

3

#1 x2PCS
M6*15mm

#6 x2PCS
M6

70%
#10

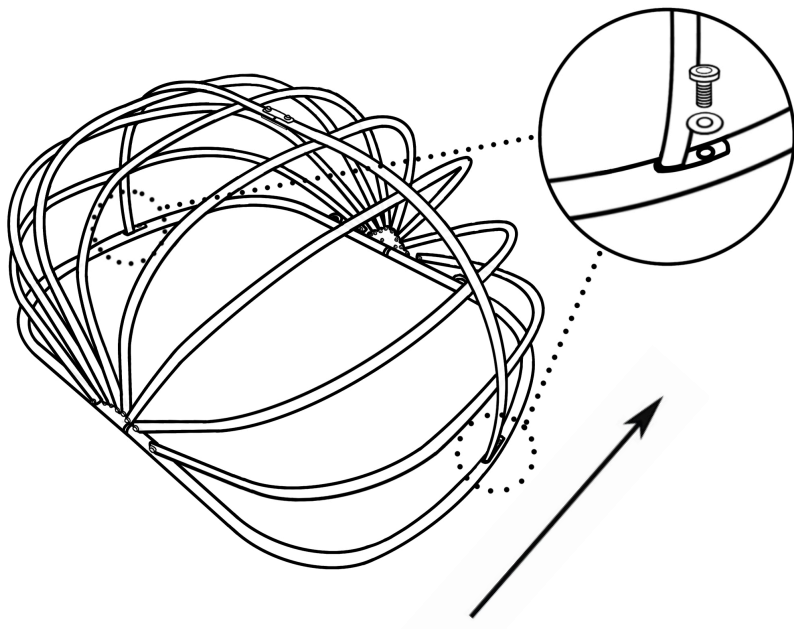

4

#3 x4PCS
M6*40mm

#6 x8PCS
M6

#7 x4PCS
Nut M6

100%
#10&11

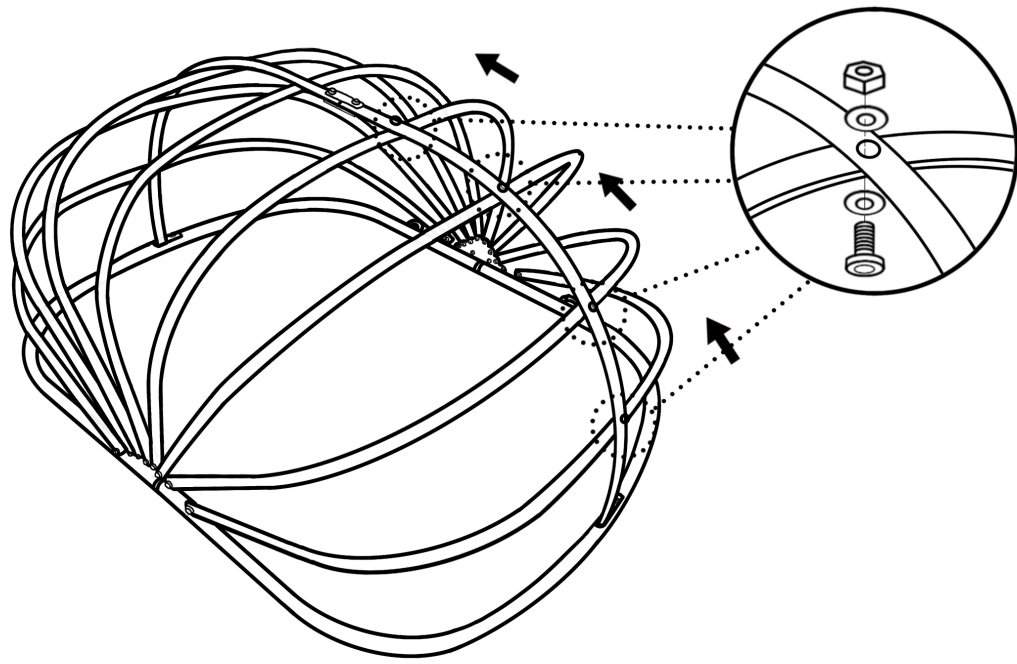

5

#3 x4PCS
M6*40mm



#6 x8PCS
M6



#8 x4PCS
Nut M6



#10&11

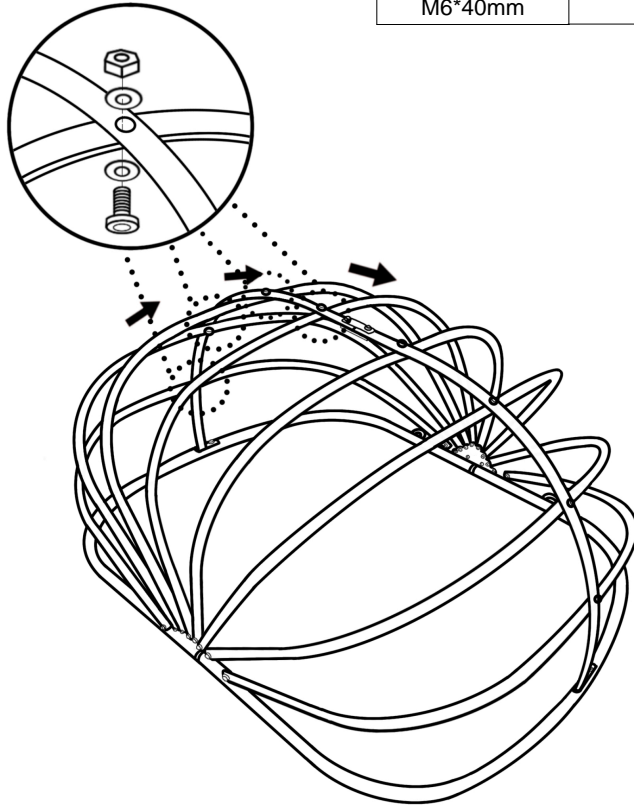

6

#1 x2PCS
M6*15mm



#6 x2PCS
M6

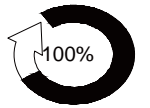

10

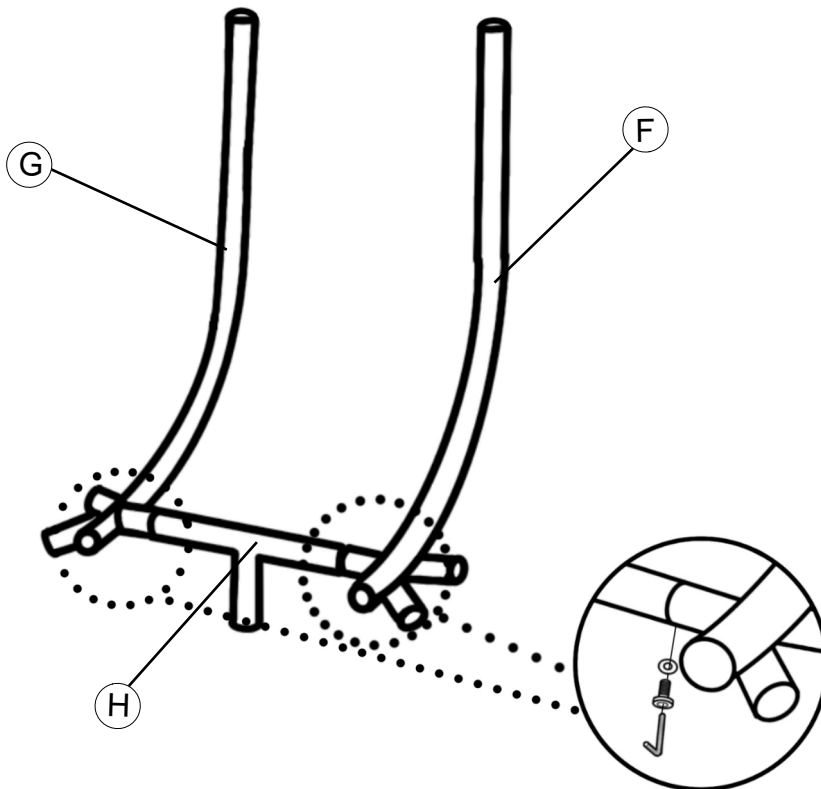

7

#1 x4PCS



M6*15mm

#6 x4PCS



M6

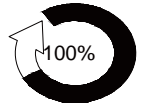

10

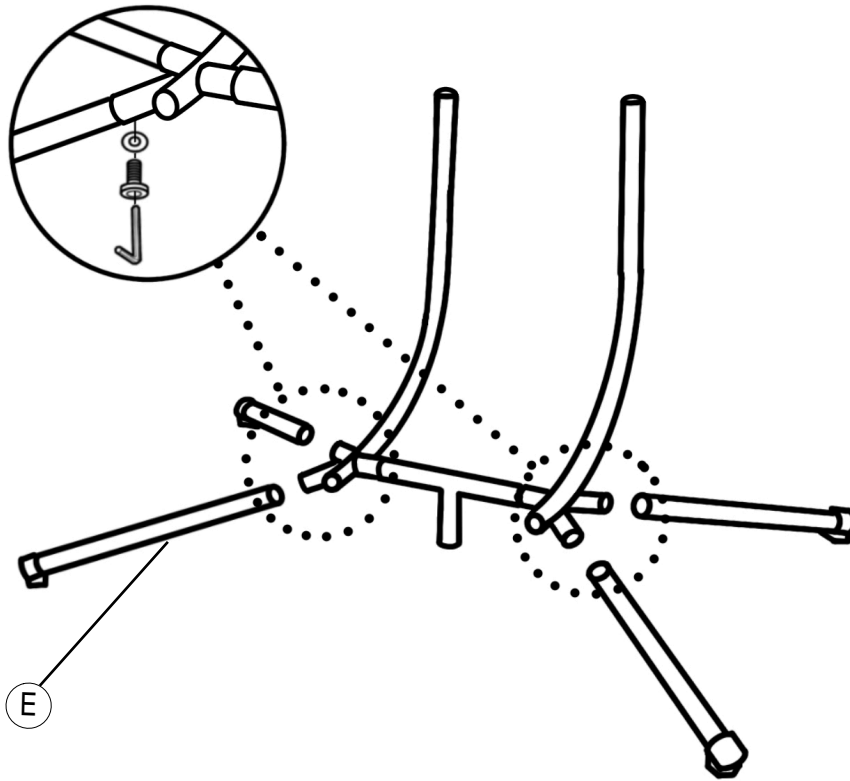

8

#5 x2PCS



M10*60mm

#9 x4PCS



M10*15

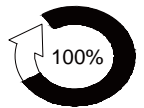

#12

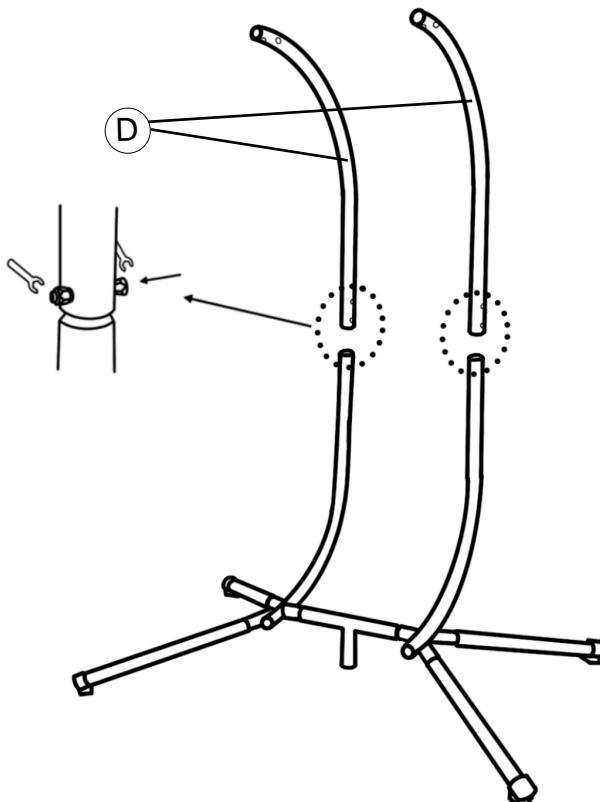

9

#4 x4PCS



M8*55mm

#7 x4PCS



M8

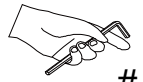

10

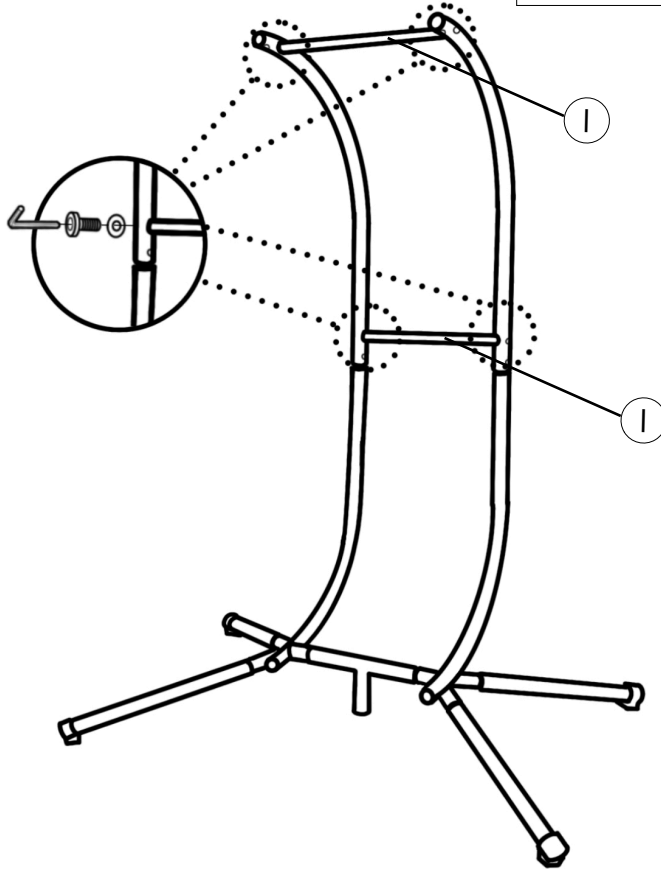

10

#13x2PCS

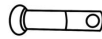

#14x2PCS



#15x2PCS



#16 x2PCS

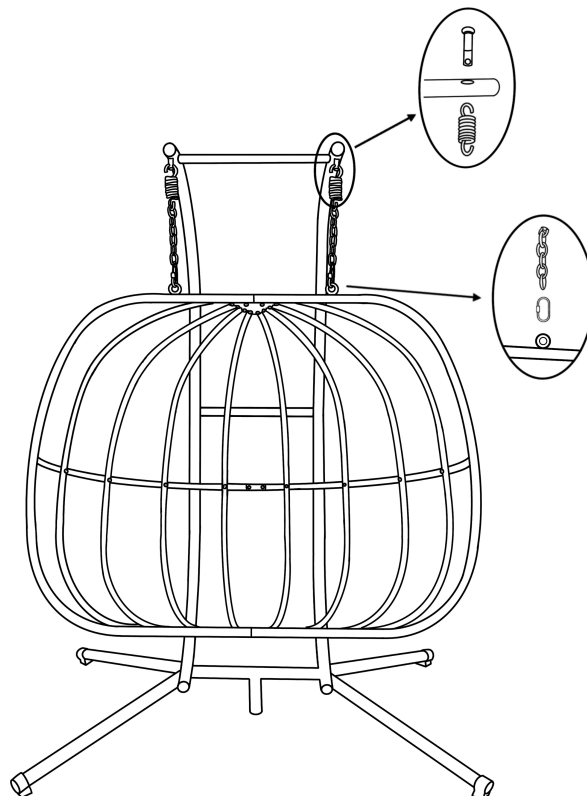

11

#17 x2PCS

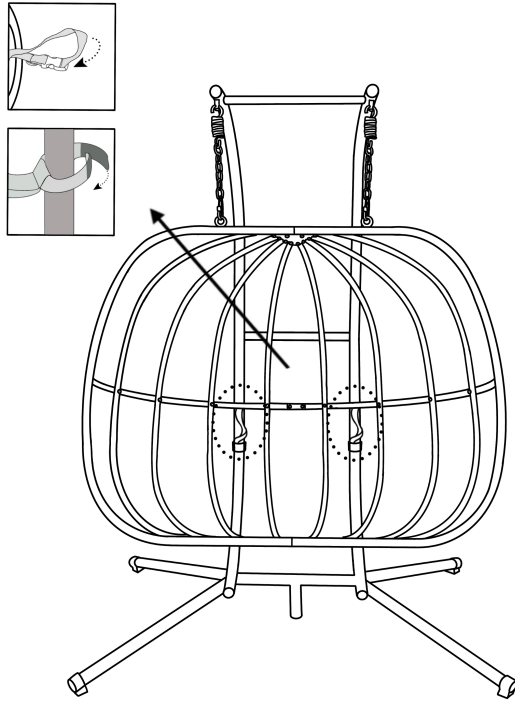

12

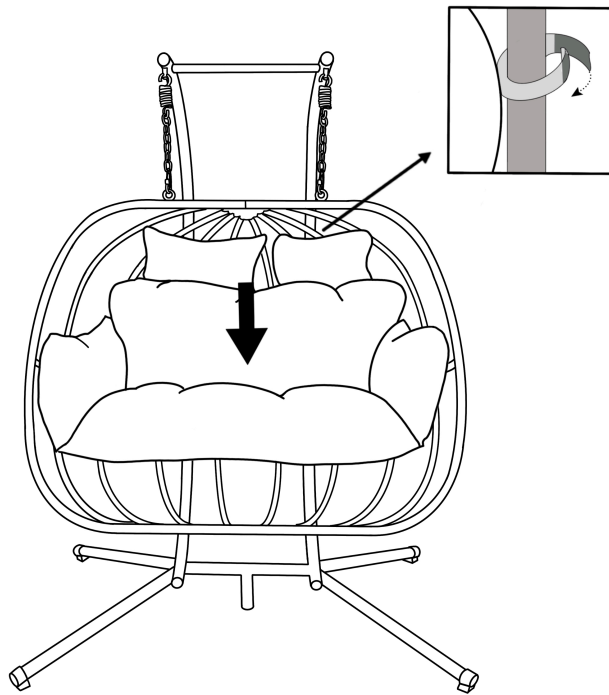

13

Adjust the seat height by adjusting the chain.

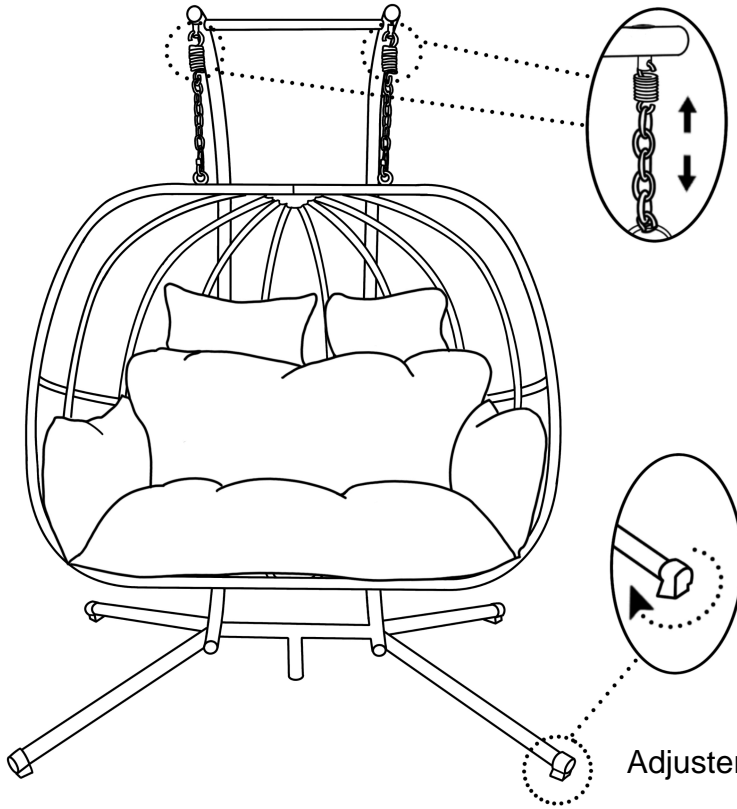

Adjusters are for leveling.