



ASSEMBLY INSTRUCTION

MODEL :



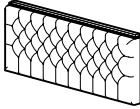

DESCRIPTION : KING HEADBOARD + WING

Thank you for purchasing this quality product. Be sure to check all packing material carefully for small parts which may have loose inside the carton during shipment. Identify and count all parts and compare with the parts list below.

(BOX 1)
BOX OF HEADBOARD & EXTENSION POST

NO	DRAWING	DESCRIPTION	QTY
A		Headboard	1pc
B		Headboard Post - (L/R)	2pcs

(BOX 1)
HARDWARE LIST

NO	DRAWING	DESCRIPTION	QTY
1		Allen key	1pc
2		JCBB M8 x 40mm	6pcs
3		M8 Spring washer	6pcs
4		5/16" Flat washer	6pcs
5		Wood Dowel M8 x 30mm	4pcs

Open the fabric at the back of headboard on the left & right side as diagram show to assembly the headboard post.

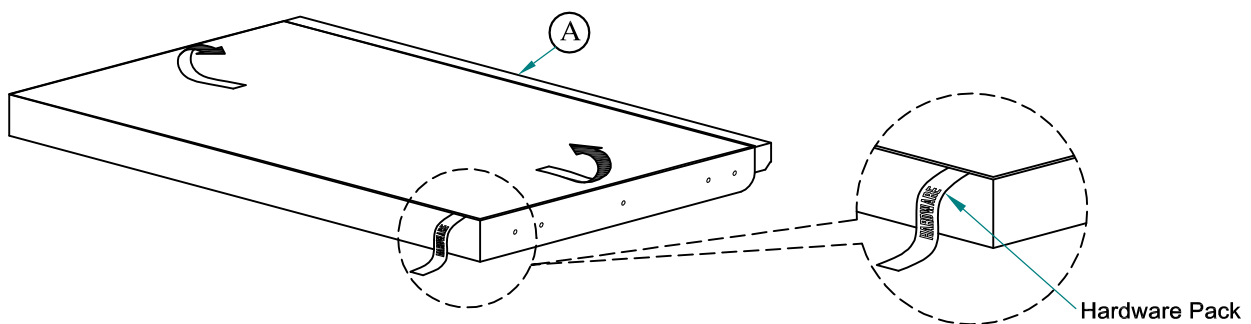

THE HARDWARE IS LOCATED IN THE PACKING ITEM

NOTE : MUST TIGHTEN SCREW PERIODICALLY. WITH USE SCREW MAY BECOME LOOSE.
CHECK TIGHTNESS OF ALL SCREW EVERY 6-8 WEEKS.

CLEANING INSTRUCTION

After assembly , clean & polish the completed parts if necessary with softcloth and industrial recognized furniture polish

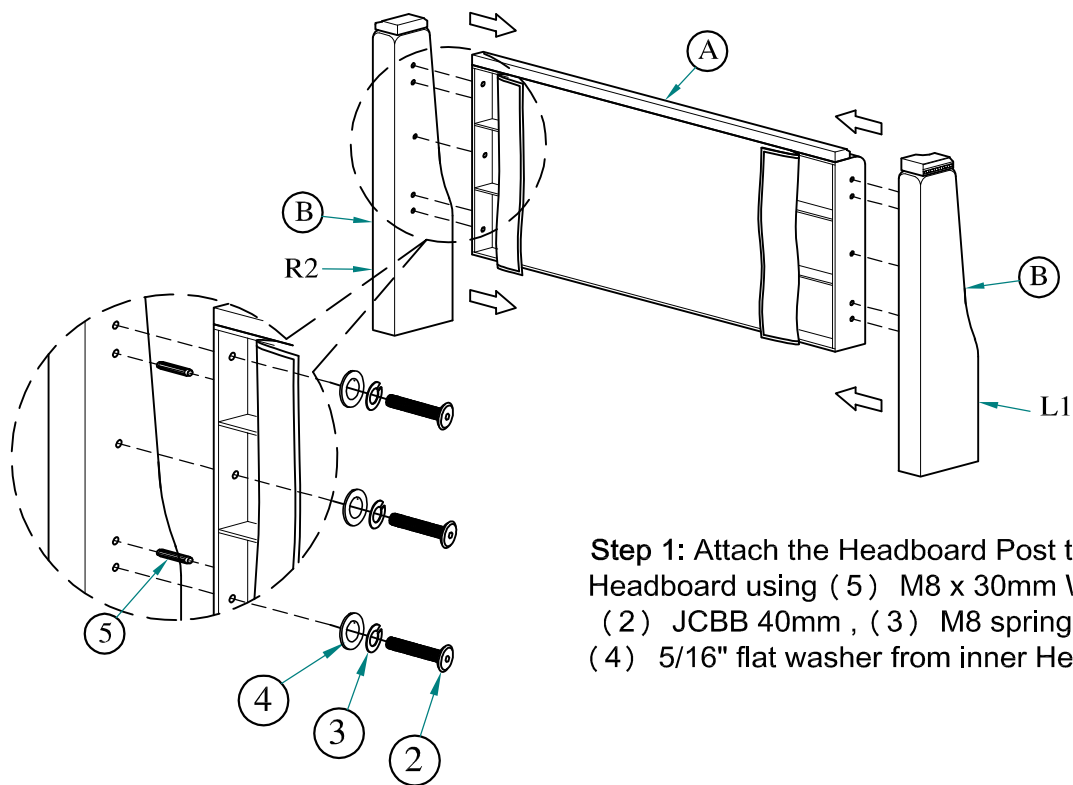

Step 1: Attach the Headboard Post to the Headboard using (5) M8 x 30mm Wood Dowel , (2) JCBB 40mm , (3) M8 spring washer & (4) 5/16" flat washer from inner Headboard.

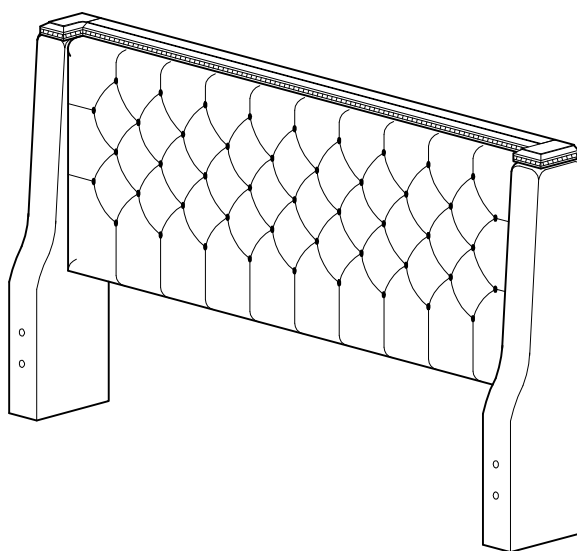

Assembly completed

ASSEMBLY INSTRUCTION

MODEL :

DESCRIPTION : KING BED

Thank you for purchasing this quality product. Be sure to check all packing material carefully for small parts which may have loose inside the carton during shipment. Identify and count all parts and compare with the parts list below.





(BOX 1)

BOX OF HEADBOARD

NO	DRAWING	DESCRIPTION	QTY
A		Headboard	1pc

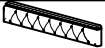



(BOX 2)

BOX OF FOOTBOARD

NO	DRAWING	DESCRIPTION	QTY
B		Footboard	1pc
C		Bun Foot	2pcs
D		Slat	5pcs
E		Slat support leg	10pcs

(BOX 2)

HARDWARE LIST

NO	DRAWING	DESCRIPTION	QTY
1		Allen key	1pc
2		JCBC 35mm	10pcs
3		M6 Spring washer	10pcs
4		Screw 32mm	10pcs
5		Adjustable Leveller	10pcs

(BOX 3)

BOX OF SIDE RAIL

NO	DRAWING	DESCRIPTION	QTY
F		Side rail	2pcs

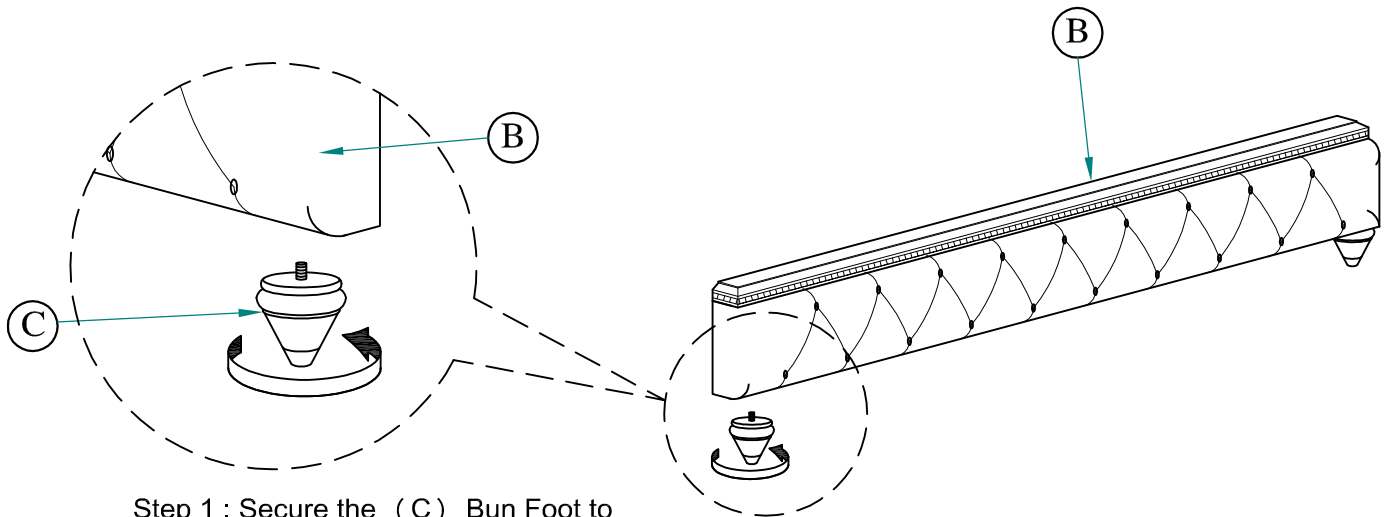

Step 1 : Secure the (C) Bun Foot to the bottom of (B) Footboard as a diagram shown.

THE HARDWARE IS LOCATED IN THE PACKING ITEM

NOTE : MUST TIGHTEN SCREW PERIODICALLY. WITH USE SCREW MAY BECOME LOOSE. CHECK TIGHTNESS OF ALL SCREW EVERY 6-8 WEEKS.

CLEANING INSTRUCTION

After assembly , clean & polish the completed parts if necessary with softcloth and industrial recognized furniture polish

Step 2: Attach (E) Slat Support Leg to the bottom of (D) Slat using (2) JCBC 35mm and (3) M6 Spring Washer. Adjust the (5) Adjustable Leveler to level the bed with the floor.

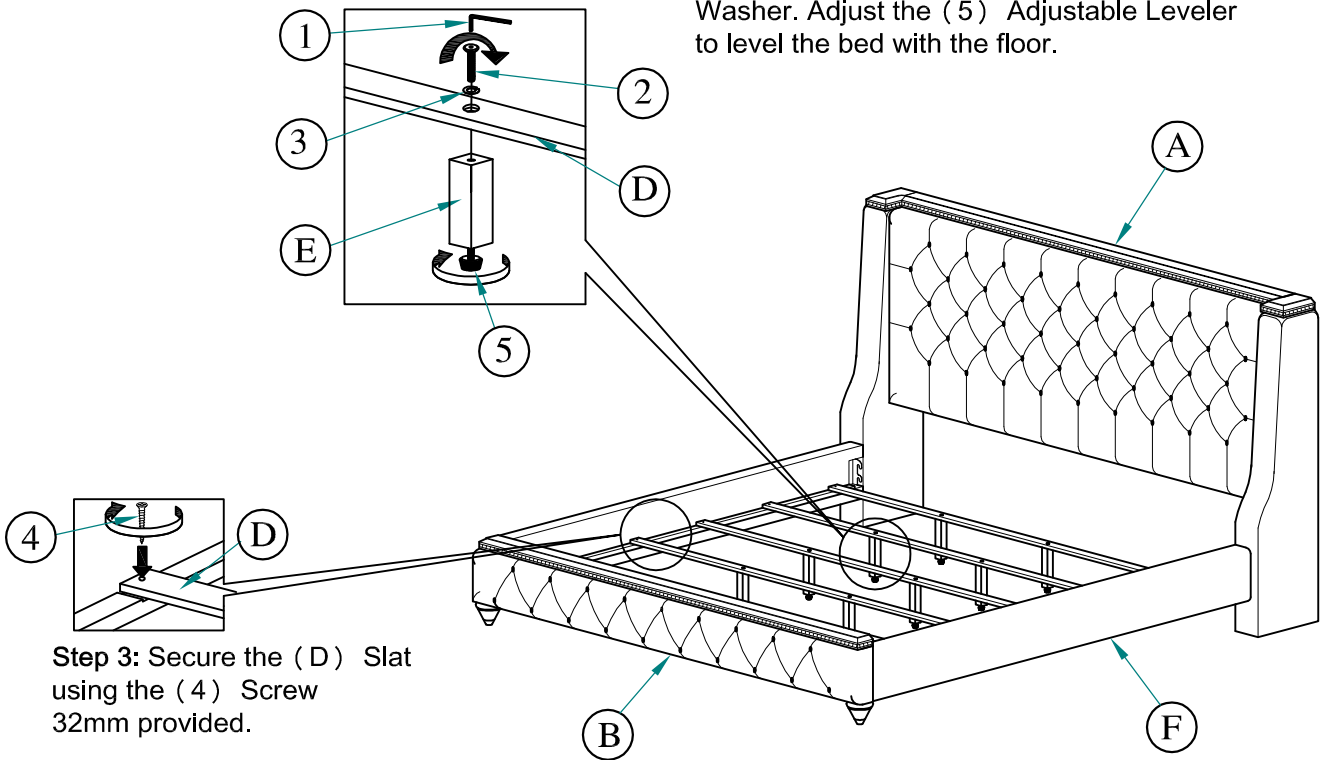

Step 3: Secure the (D) Slat using the (4) Screw 32mm provided.

Assembly completed

ASSEMBLY INSTRUCTION

MODEL :





DESCRIPTION : QUEEN BED / KING BED

Thank you for purchasing this quality product. Be sure to check all packing material carefully for small parts which may have loose inside the carton during shipment. Identify and count all parts and compare with the parts list below.

**(BOX 1)
BOX OF HEADBOARD**

NO	DRAWING	DESCRIPTION	QTY
A		Headboard	1pc





**(BOX 2)
BOX OF FOOTBOARD**

NO	DRAWING	DESCRIPTION	QTY
B		Footboard	1pc
C		Bun Foot	2pcs
D		Slat	5pcs
E		Slat support leg	Queen - 5pcs King - 10pcs

**(BOX 3)
BOX OF SIDE RAIL**

NO	DRAWING	DESCRIPTION	QTY
F		Side rail	2pcs

**(BOX 3)
HARDWARE LIST#**

NO	DRAWING	DESCRIPTION	QTY
1		Allen key	1pc
2		JCBB M8 x 30mm	8pcs
3		M8 Spring washer	8pcs
4		5/16" Flat washer	8pcs

THE HARDWARE IS LOCATED IN THE PACKING ITEM

NOTE : MUST TIGHTEN SCREW PERIODICALLY. WITH USE SCREW MAY BECOME LOOSE.
CHECK TIGHTNESS OF ALL SCREW EVERY 6-8 WEEKS.

CLEANING INSTRUCTION

After assembly , clean & polish the completed parts if necessary with softcloth and industrial recognized furniture polish

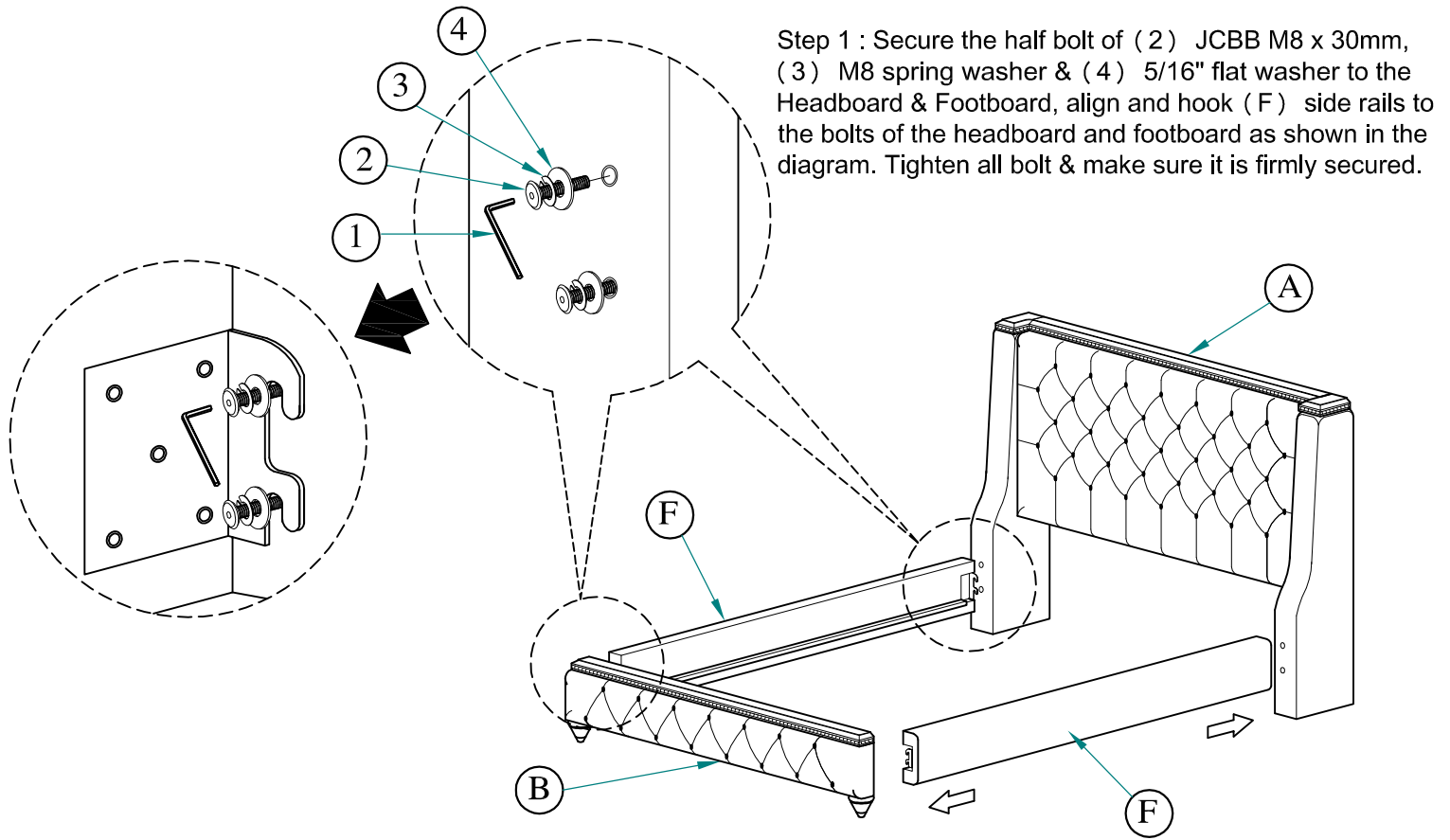

Step 1 : Secure the half bolt of (2) JCBB M8 x 30mm, (3) M8 spring washer & (4) 5/16" flat washer to the Headboard & Footboard, align and hook (F) side rails to the bolts of the headboard and footboard as shown in the diagram. Tighten all bolt & make sure it is firmly secured.

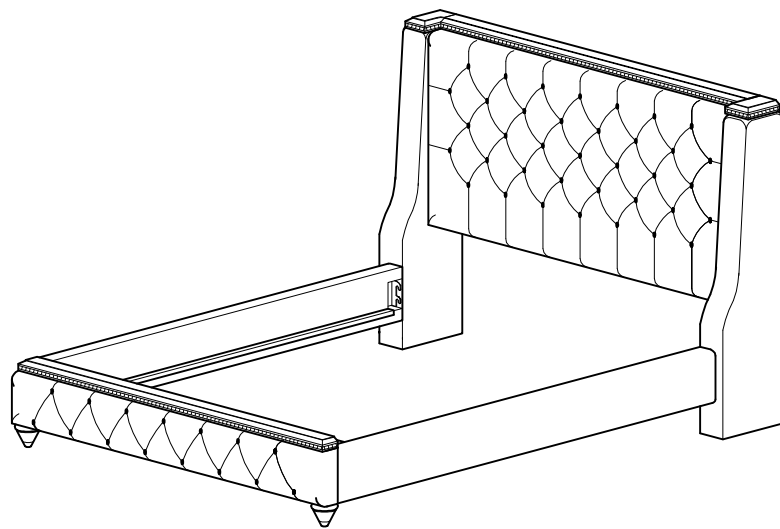

Assembly completed