

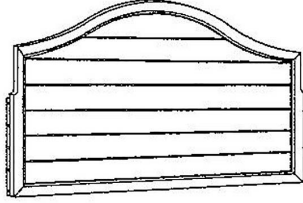





ASSEMBLY INSTRUCTION

QUEEN POSTER HEADBOARD KING POSTER HEADBOARD

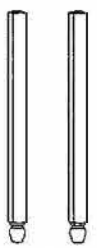
A Headboard Panel  1 pc	B Bed Post (Top)  2 pcs	C Bed Post (Bottom)  2 pcs
D JCBC Bolt M6 X 50mm  6 pcs	E Flat Washer M8 x 16mm  6 pcs	F Spring Washer 5/16"  6 pcs
G Allen Key M4  1 pc	H Wooden Dowel Ø8 X 30mm  4 pcs	

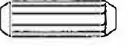
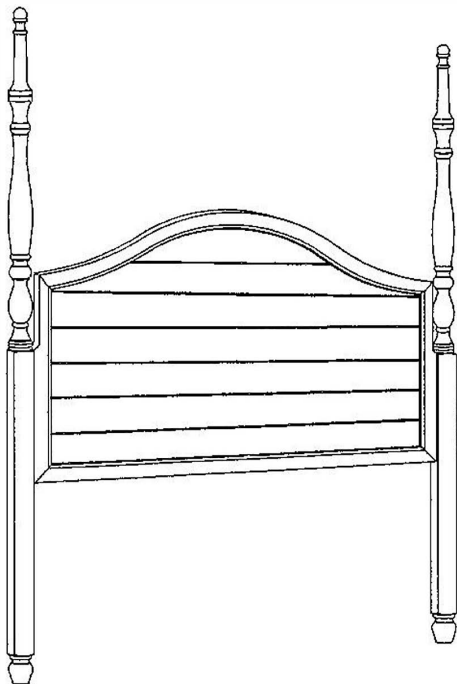

This page lists all the contents included in the box. Please take the time to identify the hardware as well as the individual components to this product. As you unpack and prepare for assembly, place the contents on a carpeted or padded area to protect them from damage.

IMPORTANT NOTE :

1. Do not tighten all screws / bolts until all completely assemble.
2. Keep all hardware parts out of reach of children.

1 Insert Wooden Dowel (H) to the left & right holes at the Headboard Panel (A).

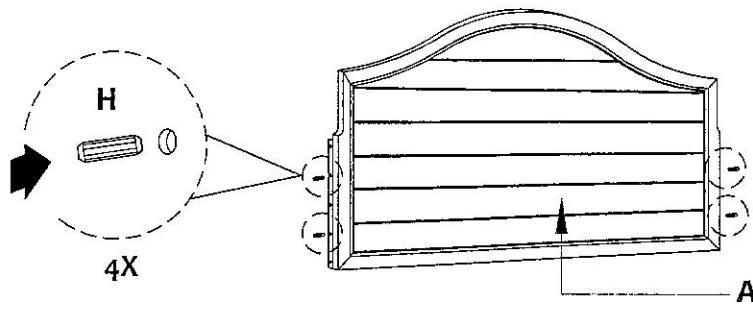

2 Attached Bed Post (Bottom)(C) to Headboard Panel (A). Insert JCBC Bolt (D), Spring Washer (F) and Flat Washer (E) to the holes and tighten using Allen Key (G).

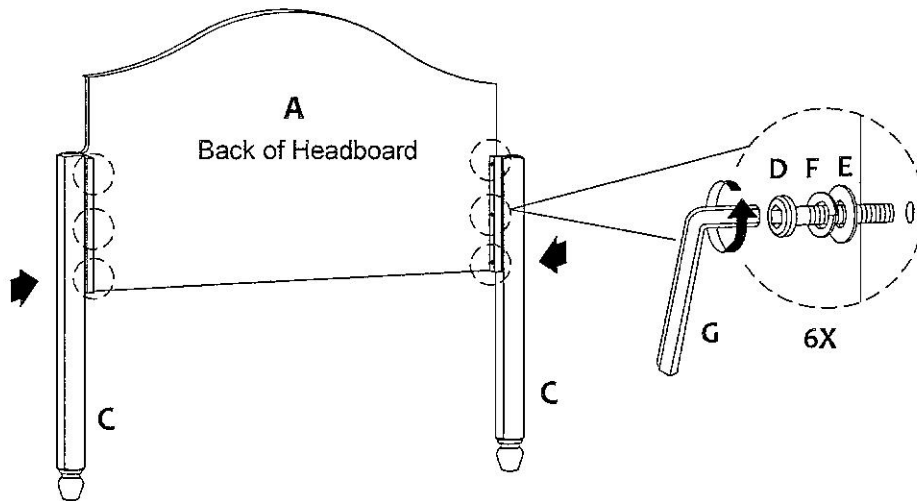

3 Align the Hanger Bolt of Bed Post (Top)(B) to the hole of Bed Post (Bottom)(C). Turn the Bed Post (Top)(B) to secure it.

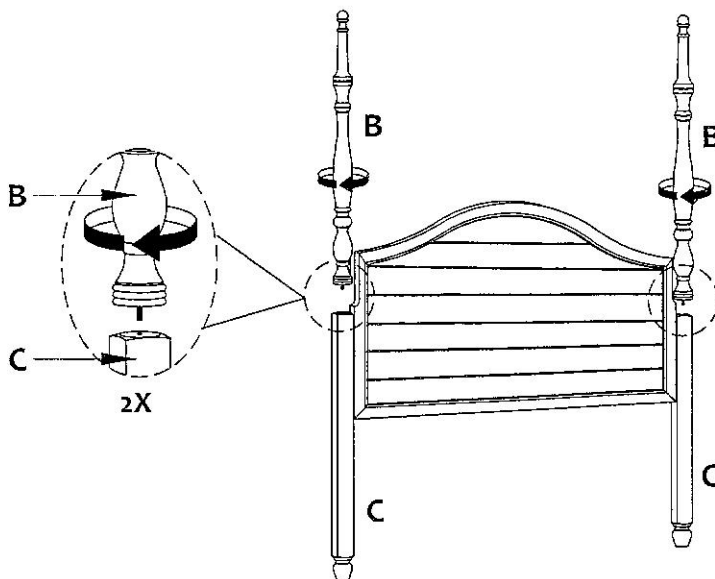

CLEANING & CARE

Treat surface with care. Surface is resistant to scratches but is not scratches resistant. Clean surface with a dry or damp soft cloth. Do not use abrasive cleaners. Hardware may loosen over time. Periodically check that all connections are tight.