

USER GUIDE



METAL GARDEN SHED

WARNING & OPERATION

Warning

- Please read the instruction manual carefully before assembly.
- Please assembly strictly in accordance with the instruction.
- Please double-check to ensure that all parts of the package contents intact.
- To avoid injury, work gloves are recommended during assembly.

Before Installation

- Before beginning installation, check local building codes regarding footings, location and other requirements. Study and understand this instruction. Important information and helpful tips will make your installation easier and more enjoyable.
- Tools and Materials: There are some basic tools and materials you will need for the installation. Decide which method of anchoring and the type of foundation you wish to use in order to form a complete list of the materials you will need.
- Assembly Instruction: Instructions are supplied in this manual and contain all appropriate information for your installation. Review all instructions before you begin, and during assembly, follow the step sequence carefully for correct results.
- Parts List: Check to be sure that you have all the necessary parts and quantities in your package. These are packaged within the carton. Note that extra fasteners have been supplied for your convenience.
- Explosion Diagram: All parts except screws and bolts are shown in this diagram, review all parts before you begin. Familiarize yourself with the hardware and fasteners for easier use during installation.

COMPONENTS



B1: (x1)



B2: (x1)



BL: (x1)



BR: (x1)



UP1: (x1)



L1: (x1)



L2: (x1)



L3: (x1)



W1A: (x5)



W2A: (x4)



W3A: (x1)



P1: (x2)



P2: (x1)



P3: (x1)



M3: (x4)



M4: (x2)



ULA: (x1)



URA: (x1)



S2: (x1)



S3: (x1)



S4: (x1)



GC: (x4)



DA: (x1)



F1: (x150)



F2: (x2)



F3: (x8)



V1: (x150)



V2: (x150)

PART LIST

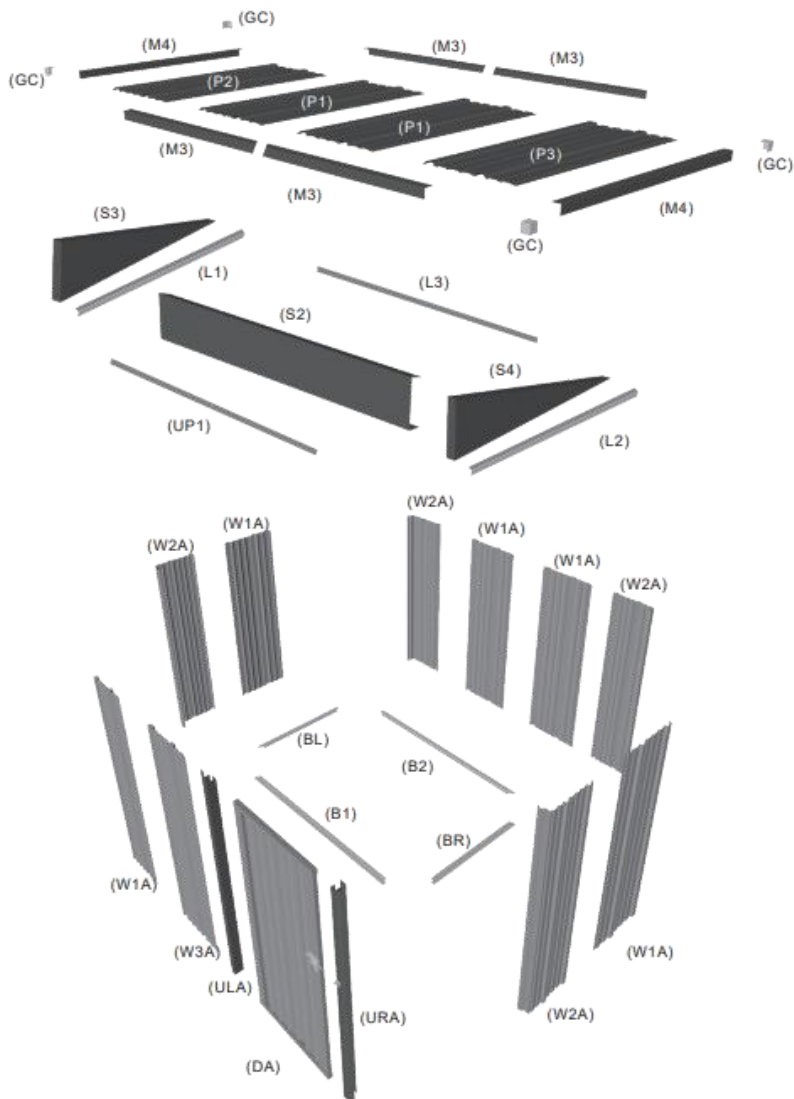







INSTALLATION

Step 1

Assemble base bars from (B1) to (BR) with screws (F1) as the picture shown below. Make sure the base bar are assembled in a perfect square.

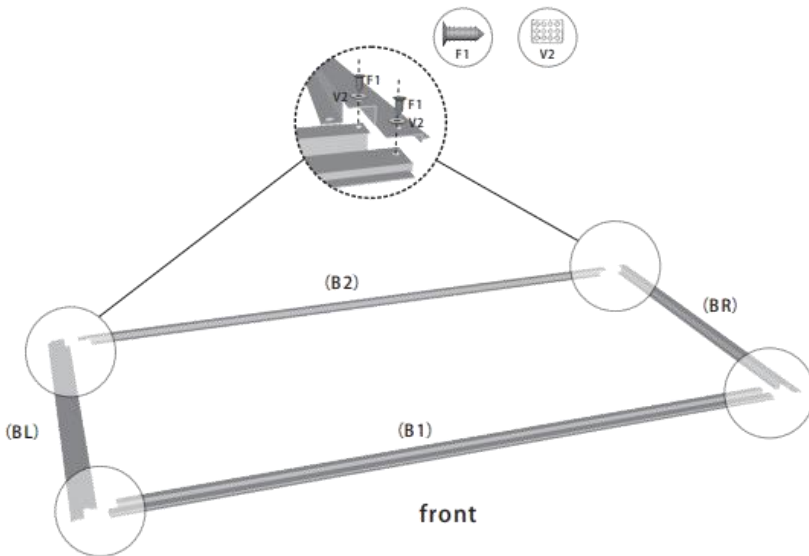

Note: Pay attention to sharp edges.

PART	NO.	Qty.
	B1	1
	B2	1
	BL	1
	BR	1
	F1	8
	V2	8



Step 2





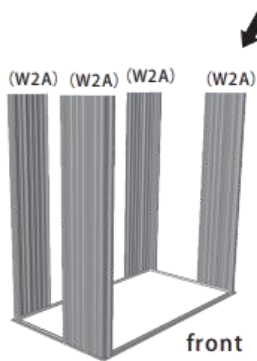
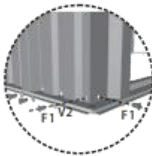
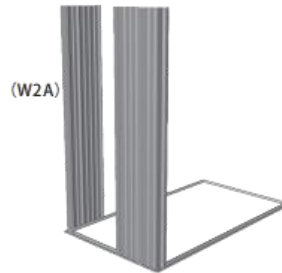
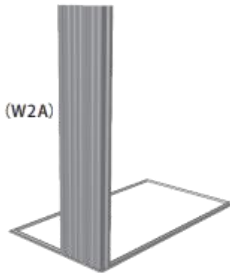

Place the wall panels (W2A) on the four corners of the base bars, and secure with screws (F1) as shown. Line up side walls of the shed with the holes of base bar.

PART	NO.	Qty.
	W2A	4
	F1	16
	V2	16



Step 3

Place the top angle bars (L1), (L3), (L2) and (UP1) on the top of wall panel. Line up the holes with wall panels and V2 with screws (F1).

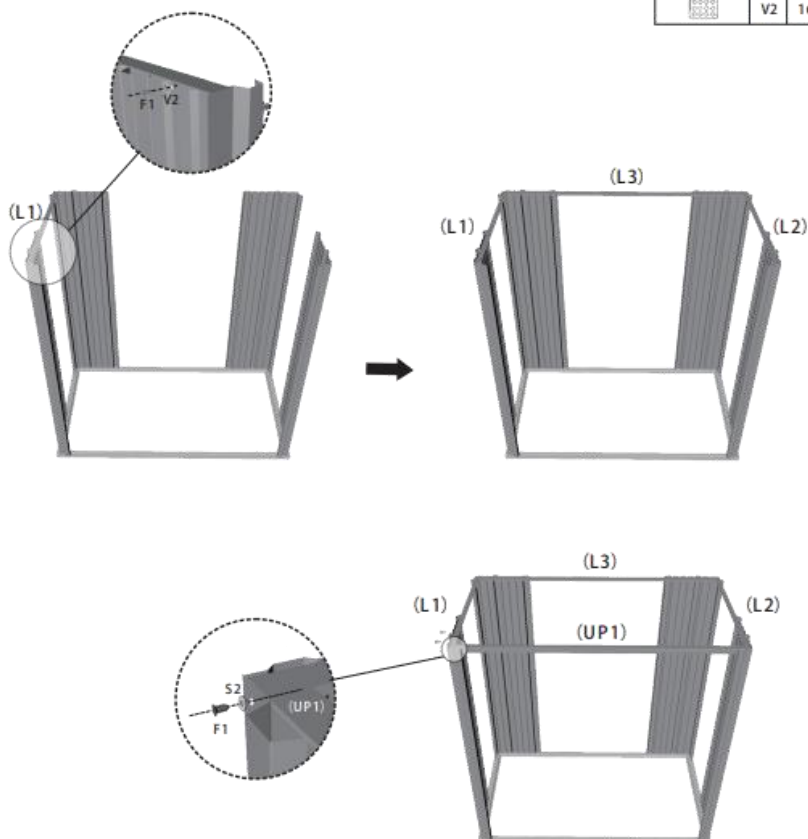

PART	NO.	Qty.
	Up1	1
	L1	1
	L2	1
	L3	1
	F1	16
	V2	16



Step 4:

Then secure the remaining wall panels around the base bars with screws (F1).

Note: Make sure the overlapping position.

PART	NO.	Qty.
	W1A	5
	W3A	1
	F1	42
	V2	42

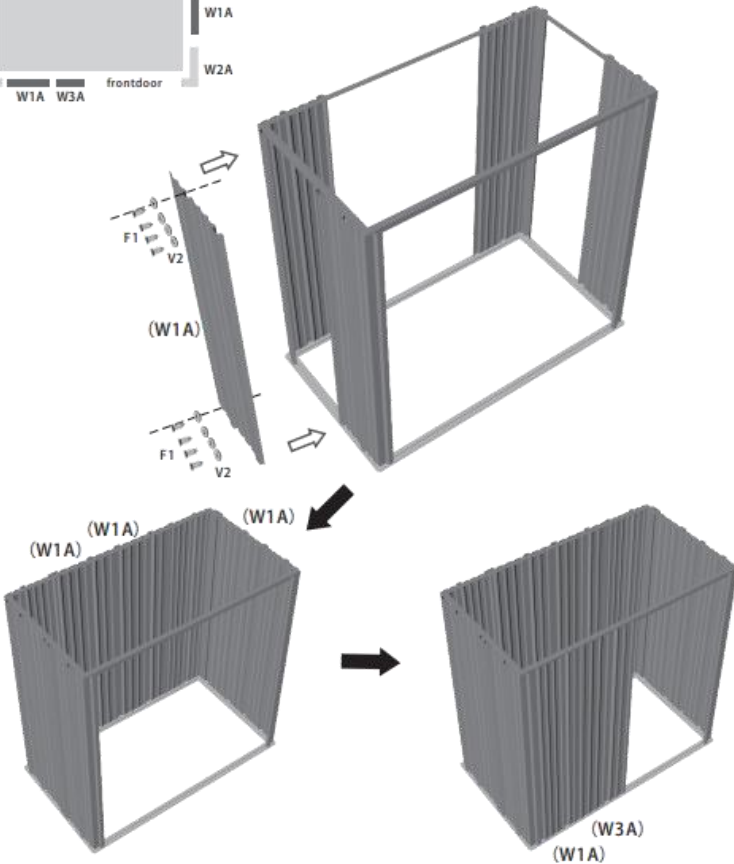

Step 5:

Place the left door column (ULA) on the top of base bar (B1), insert into the wall panel. Then secure the (UL) with screw (F1). Repeat the same step for the right door column (URA).

Note: Deep opening of the door column is on the top and shallow is below.

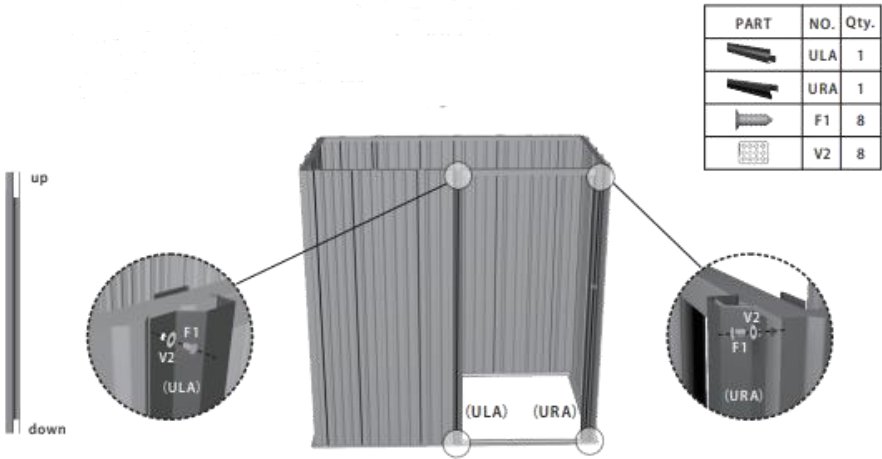

Step 6:



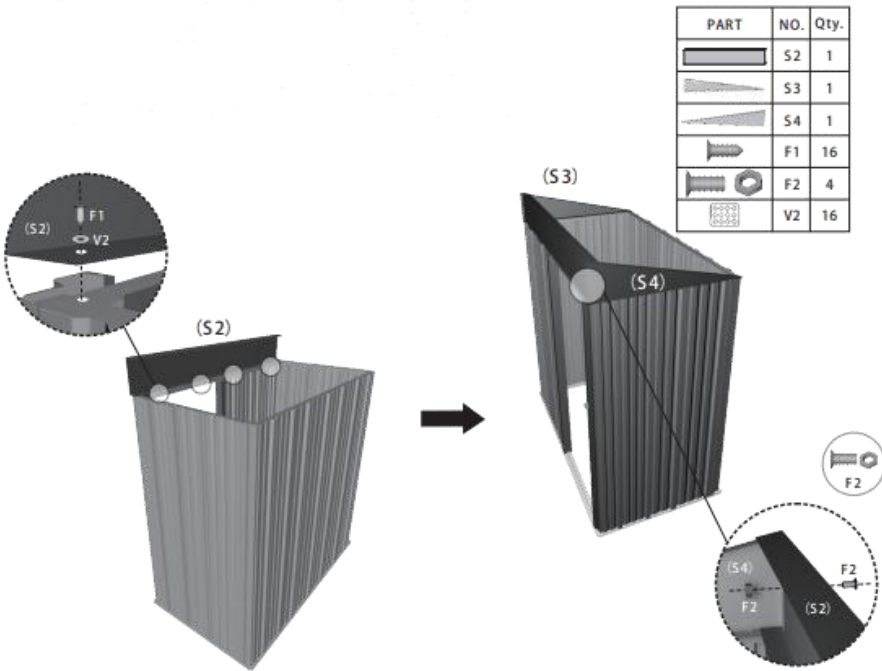

Place 3 pieces of the gable panels (S2), (S3) and (S4) on the top angle bars with screws (F1). Then connect (S2) with (S3) and (S4) via screws (F2) as the following picture shown.



Step 7:

Place the roof panels (P1), (P2) and (P3) on the top. Note: The groove protruding on the roof panel should be aligned with its corresponding side panel groove position.

Note: The groove protruding on the roof panel should be aligned with its corresponding side panel groove position.



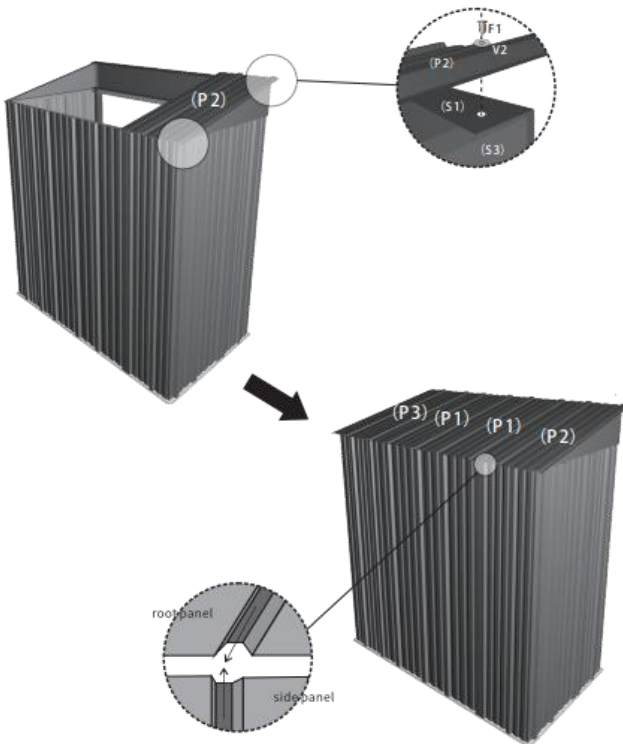

PART	NO.	Qty.
	P1	2
	P2	1
	P3	1
	F1	32
	V2	32

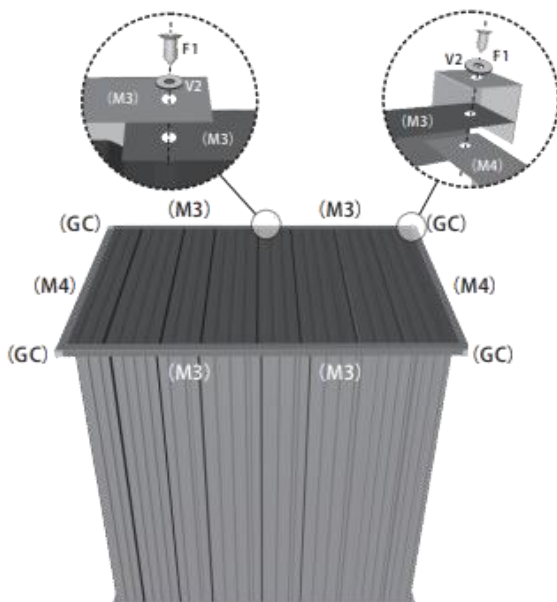

Step 8:



Assemble the roof ashing (M3) and (M4).



PART	NO.	Qty.
	M3	4
	M4	2
	GC	4
	F1	6
	V2	6

Step 9:

Connect the door panel with the door column via screws (F3) as the picture shown.

PART	NO.	Qty.
	DA	1
	F3	8

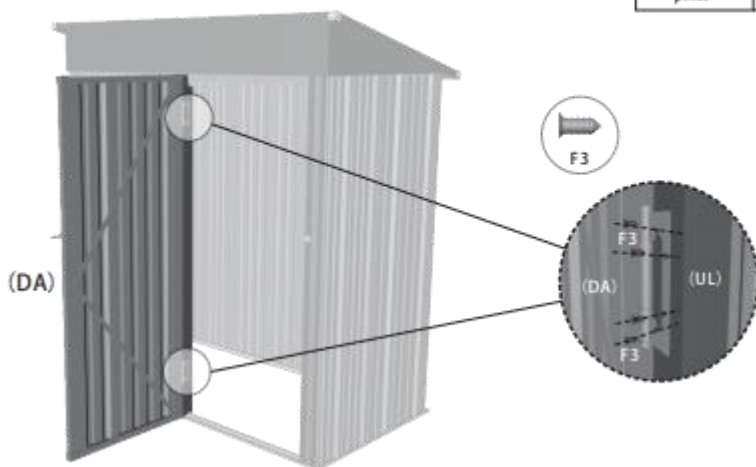

Warning:

Please use the plastic wraps (V1) to cover the end of all screws (F1) to avoid safety problems such as scratches.

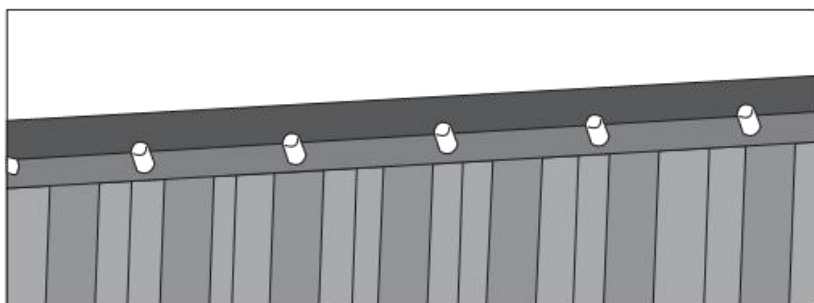
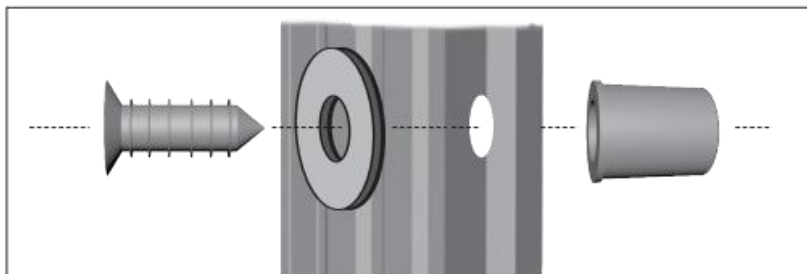

CARE & MAINTENANCE

- Wear gloves during assembly.
- Assemble the unit on a level surface.
- Keep the shed clean with soft cloth, use water if necessary.
- Clean the snow with necessary tools to make sure it is safe to enter into.
- The shed is not made for living but storing stuff.