

ASSEMBLY INSTRUCTIONS

DRESSER

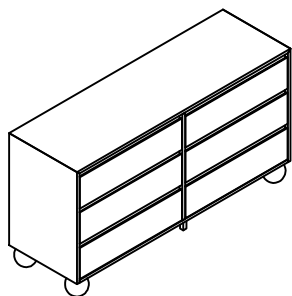

+ Do Not Use
Power Tools

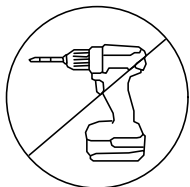

+ Suggested
Adults

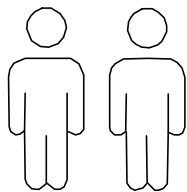

NOTE:

- 1 Read instructions cover to cover.
- 2 Save all packaging until assembly is completed.

1 IMPORTANT SAFETY INFORMATION

Do not assemble the product if any of the following parts arrived damaged:

- Part 1 - **DRESSER**
- Part 2 - **LEG BALL**
- Part 3 - **CENTER SUPPORT**

Do not assemble if any of the following Hardware parts are missing:

- Part E - **Tipping Restraint**

2 IMPORTANT ASSEMBLY INFORMATION

Assembly Step If loosening persists, please make sure to tighten all the bolts periodically, or use a thread locker adhesive.

+ Parts Included

① **DRESSER**
(1 pc)

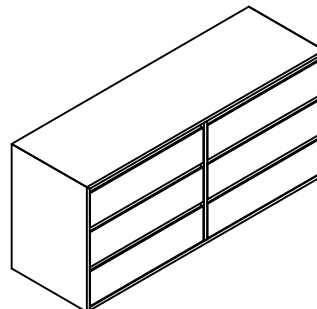

② **LEG BALL**
(4 pcs)

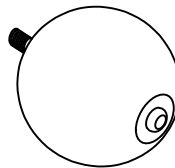

③ **CENTER SUPPORT**
(1 pc)

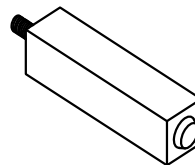

+ Hardware Included

E: Tipping Restraint
(1 set)



ASSEMBLY INSTRUCTIONS

DRESSER

1

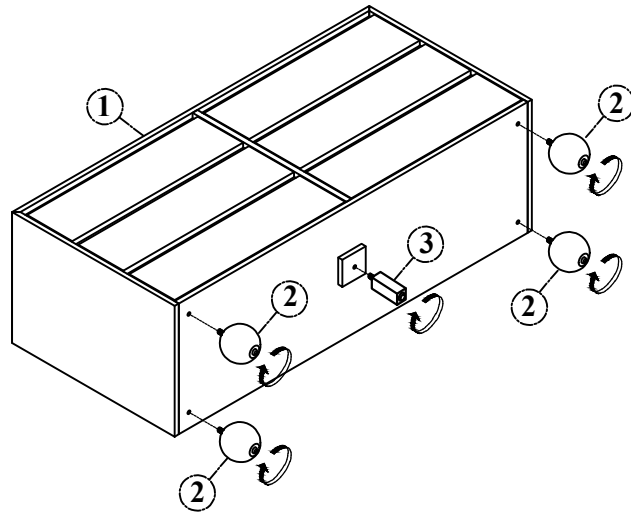

2

★ Remark: there is a tip restraint kit provided on the back of product. Please read the directions thoroughly and install immediately when placed in home

STEP 1

