

Assembly Instruction

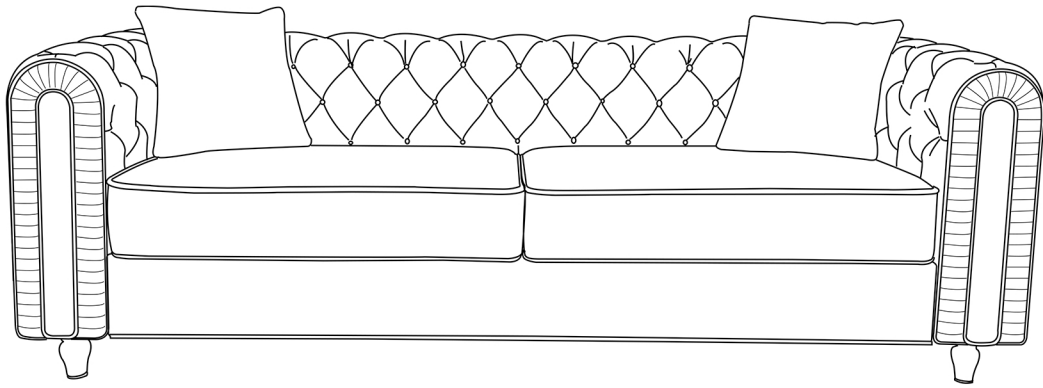

Friendly Reminder

- 1.This sofa is packed in 2 boxes.Please assemble the sofa after all boxes are received.
- 2.The seat cushions are all vacuum compressed,please allow the cushions at least 72 hours to be recovered its original size.

Return & Warranty policy

- 1.We strive to offer the highest quality products,and we also try our best to satisfy each and every customer that orders from us with replacement parts or service as needed.
- 2.If the item is damaged or defective, please take photos as evidence for replacements and refunds.
- 3.Please do not return to store,contact the seller if you have any troubles with this product.

Box 1

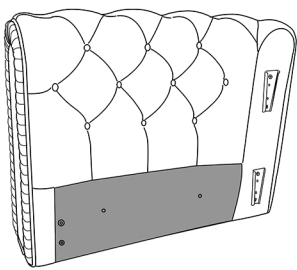

A.left arm x1pcs

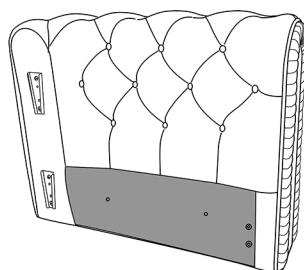

B.right arm x1pcs

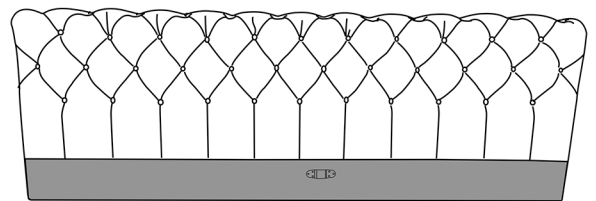

C.sofa back x1pcs

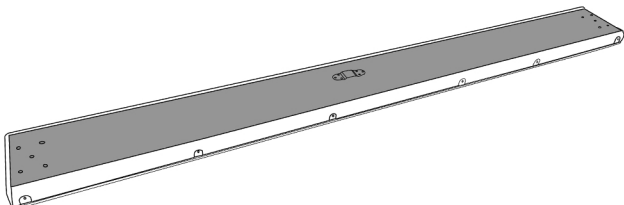

D.front board x1pcs



E.seat board x1pcs

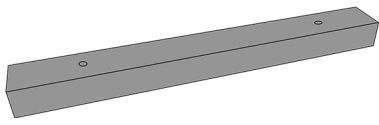

F. side bar x2pcs



G. mid bar x1pcs

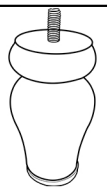

H. leg x4pcs

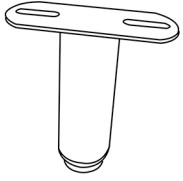

I. Mid leg x1pcs

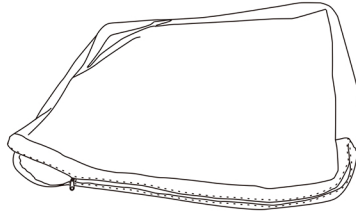

J. seat cushion cover x2pcs

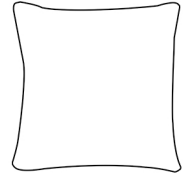

K. pillow x2pcs



L. Bracket#1 x1pcs



M. Bracket#2 x1pcs



N. washer x 6pcs

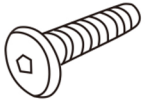

O. M6*20mm x12pcs

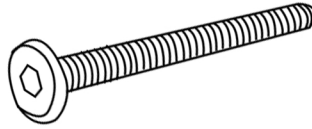

P. M6*60mm x4pcs

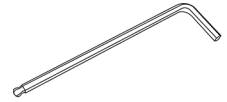

Q. hex key x1pcs

Box 2

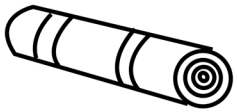

R. seat cushion x2pcs

Step 1. Insert the sofa back(C) to the left arm(A) and right arm(B) as following.

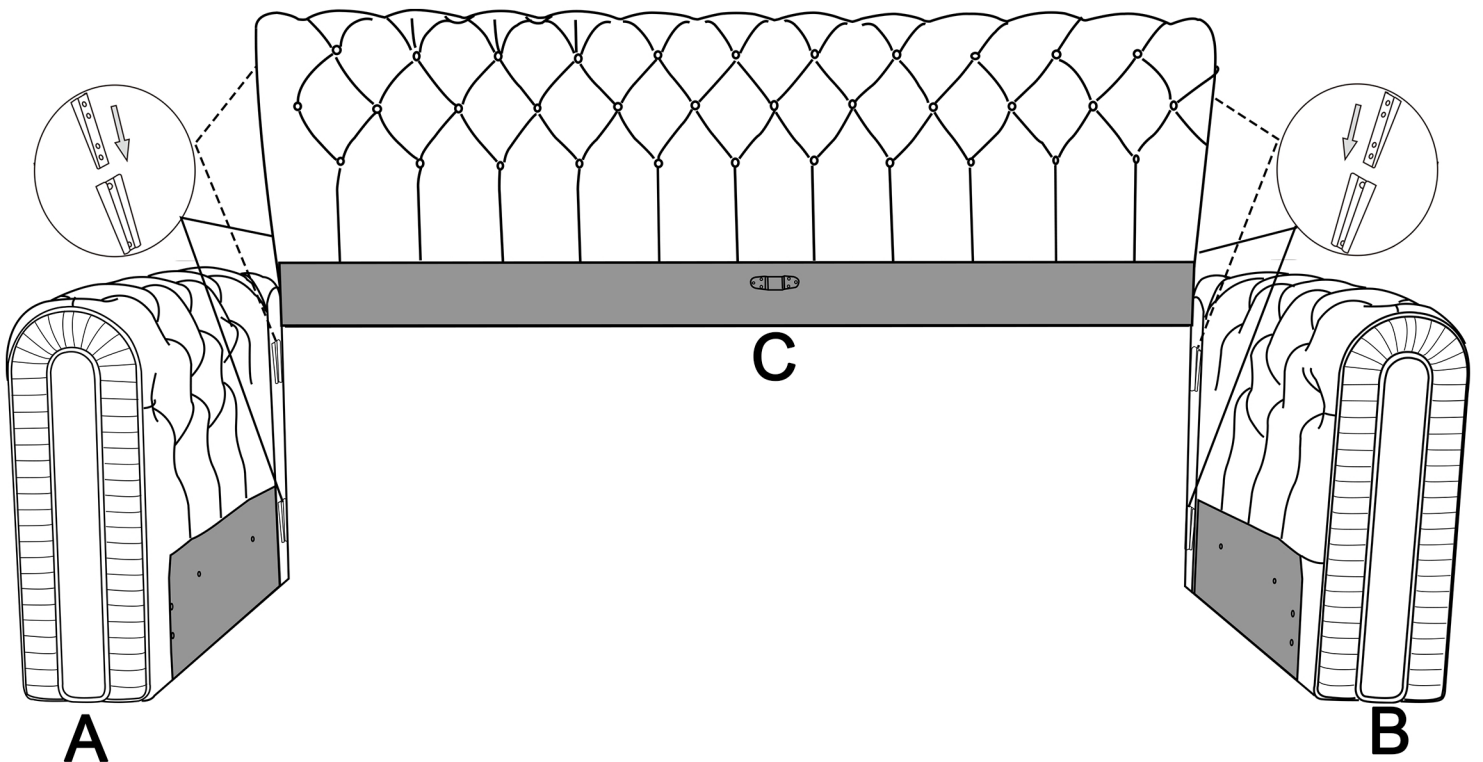

Step 2. Install the bracket#1(L)&bracket#2(M) to both side of front board(D).

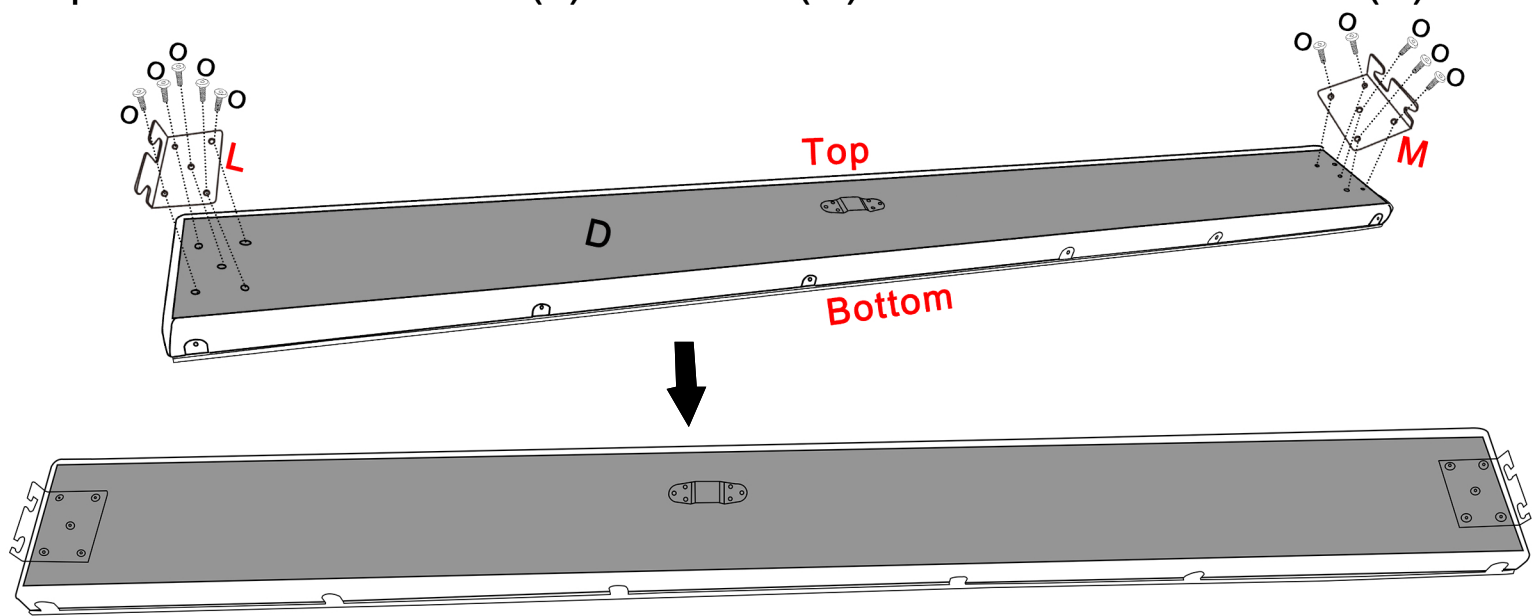

Step 3. Install the front board(D) to both armrest(A&B).

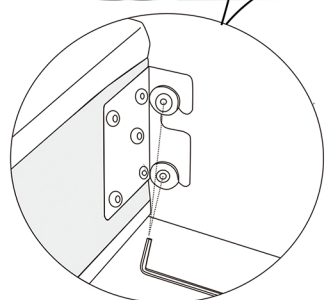
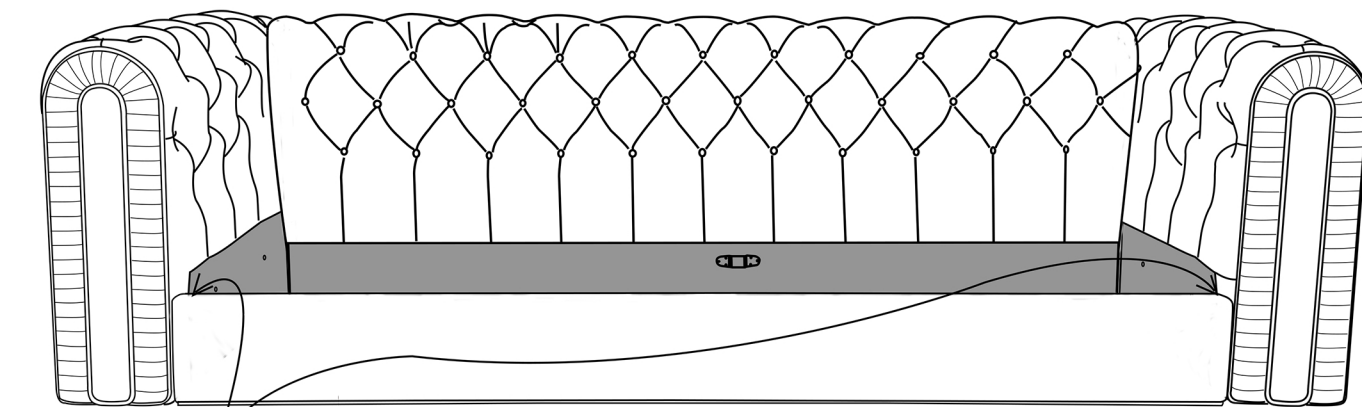
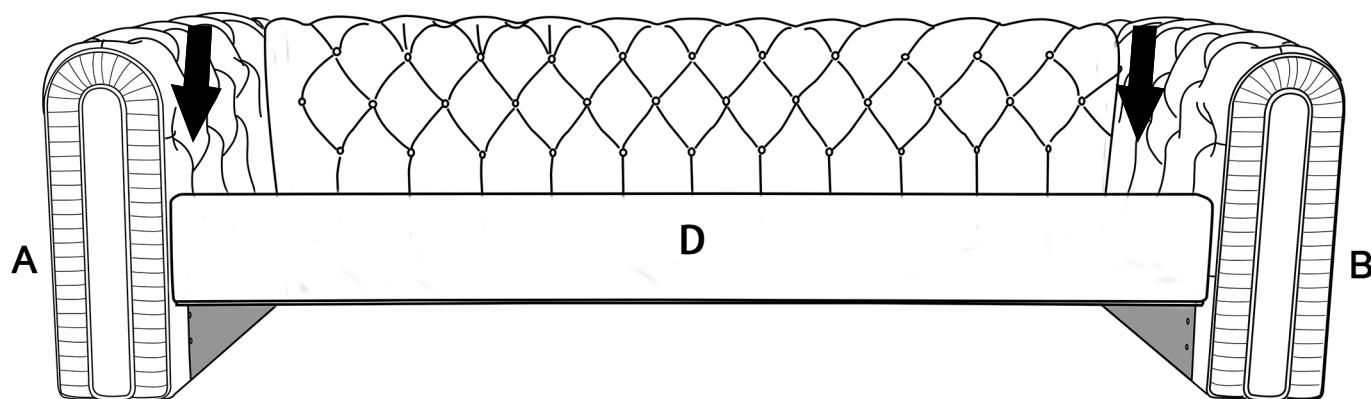

- 1) unscrew the bolt 50%
- 2) both brackets hooks on the bolts
- 3) tighten the bolts

Step 4. Install the side bar(F) to both armrest.

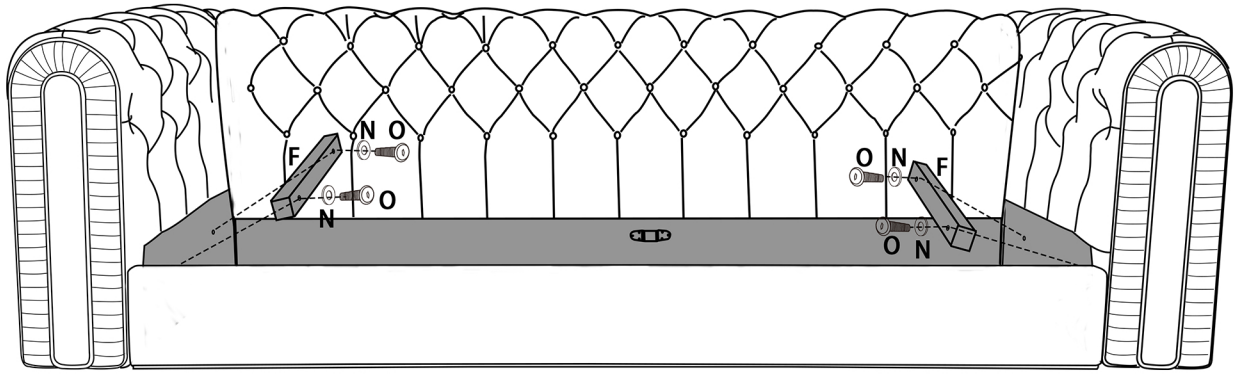

Step 5. Install the mid bar(G) to the front board and sofa back as following.

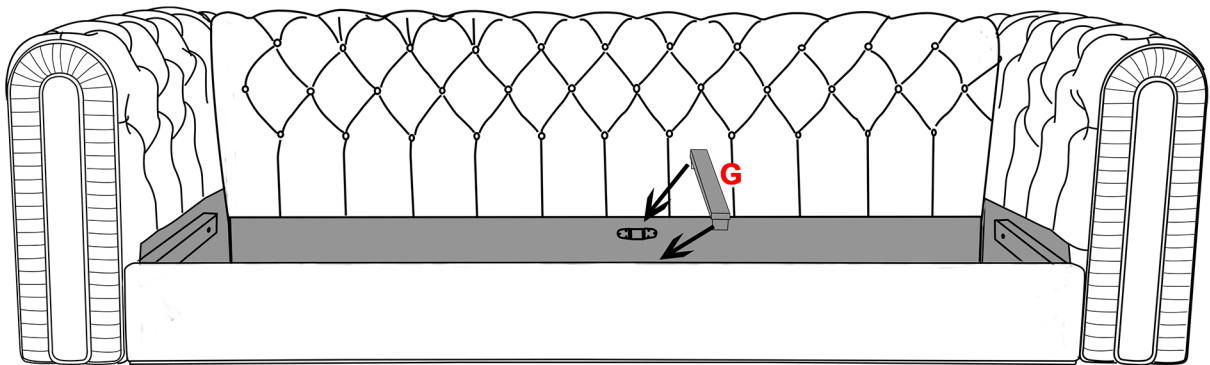

Step 6. Install the 4pcs metal legs(H) as following.

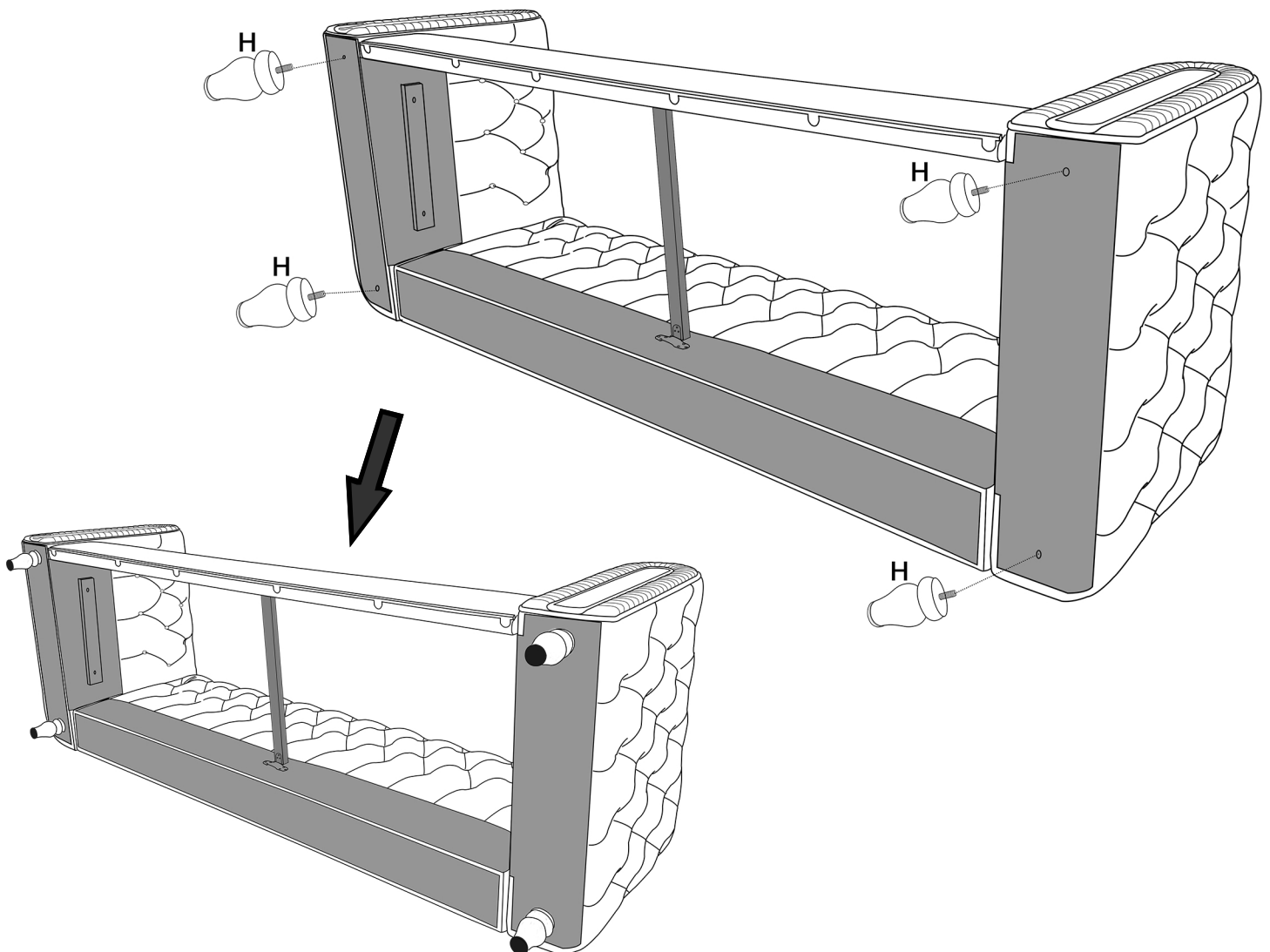

Step 7. Install the mid leg(I) to the seat board(E) first, and adjust the height of the mid leg, then put the seat board above the mid bar as following.

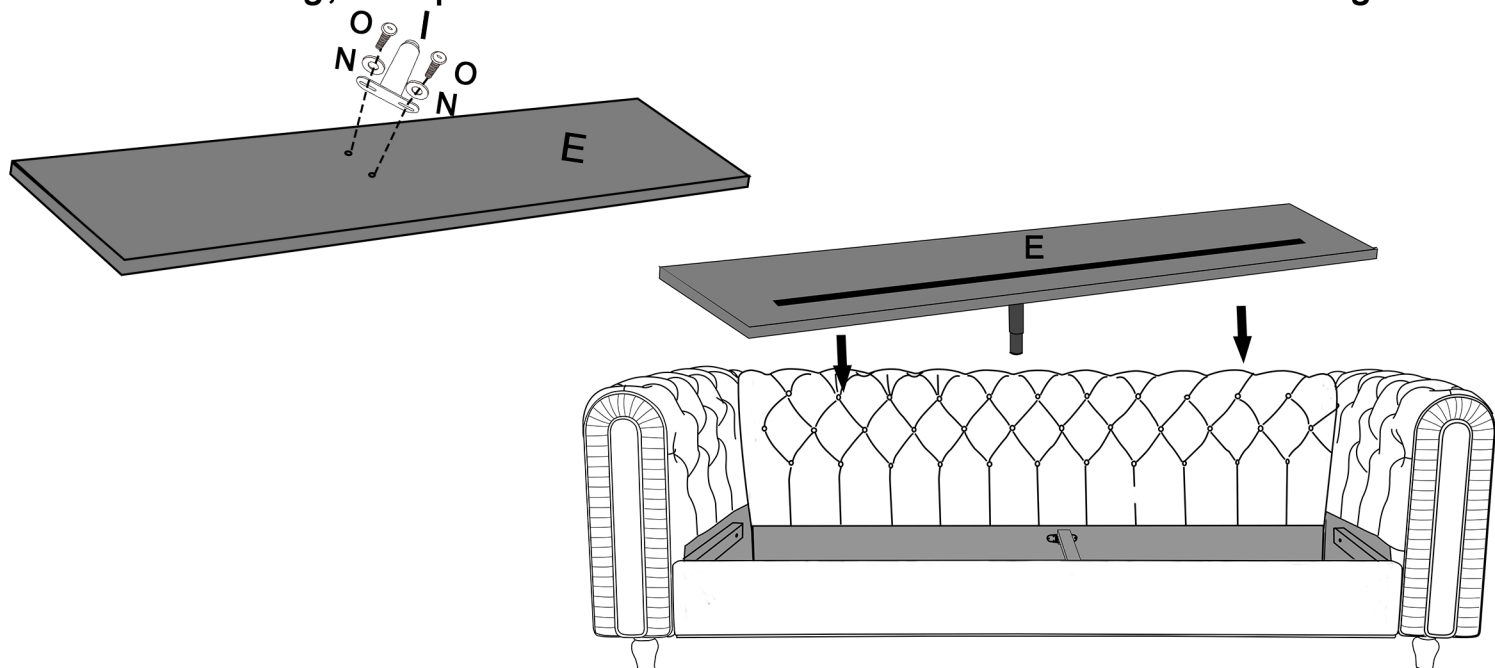

Step 8. Put the seat cushions on the seat board.

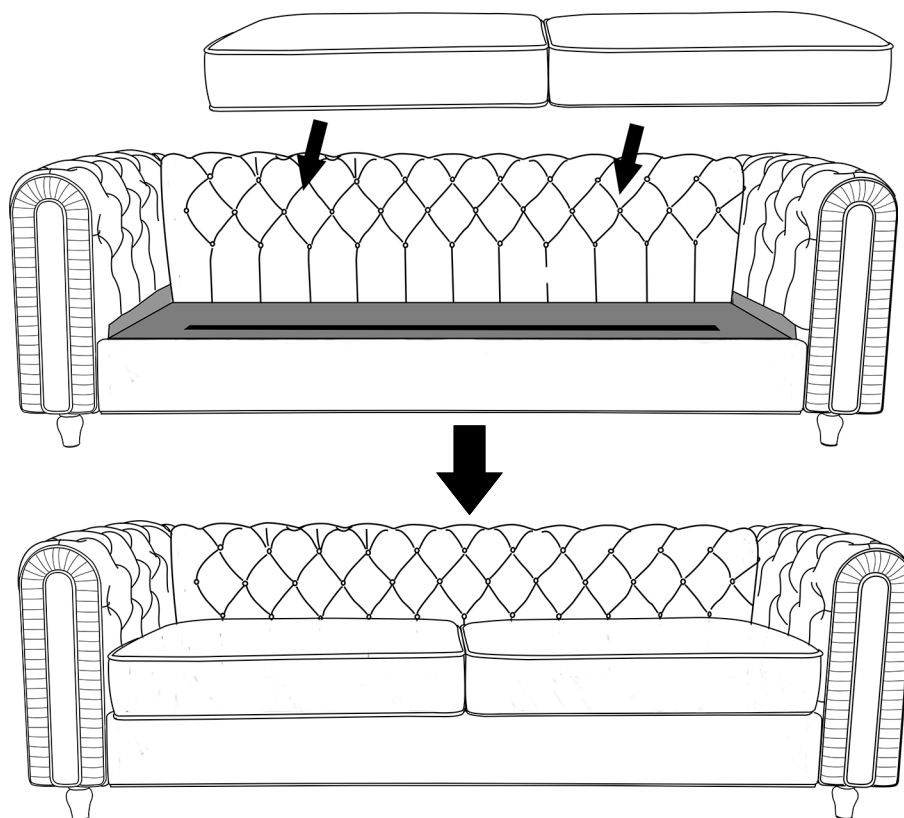

Finish

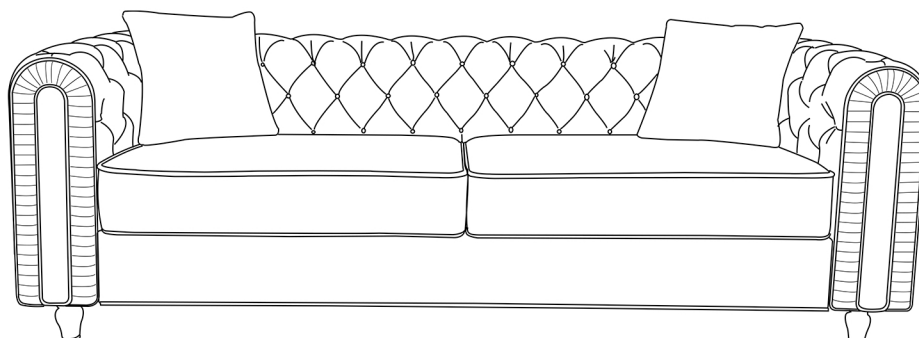

How to install the cushions

Step 1. Open the plastic bag and remove the cushions foam wrapped with polyester fiber&Non-woven bags from the plastic bag.

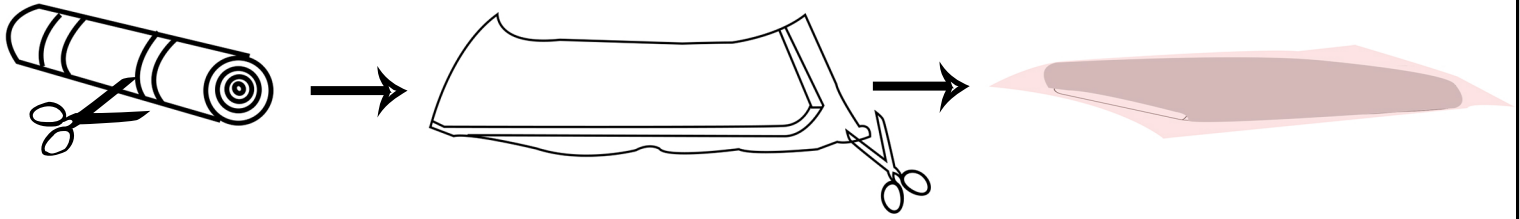

Step 2. Cover the fabric covers to all seat cushions. **PLEASE DON'T REMOVE THE NON-WOVEN BAG & POLYESTER FIBER OF THE SEAT CUSHIONS, PLEASE KEEP IT AS IT IS.** When you get the seat cushion, you will see the RED words which side is the **Top**, **Front** and **Back** as following.

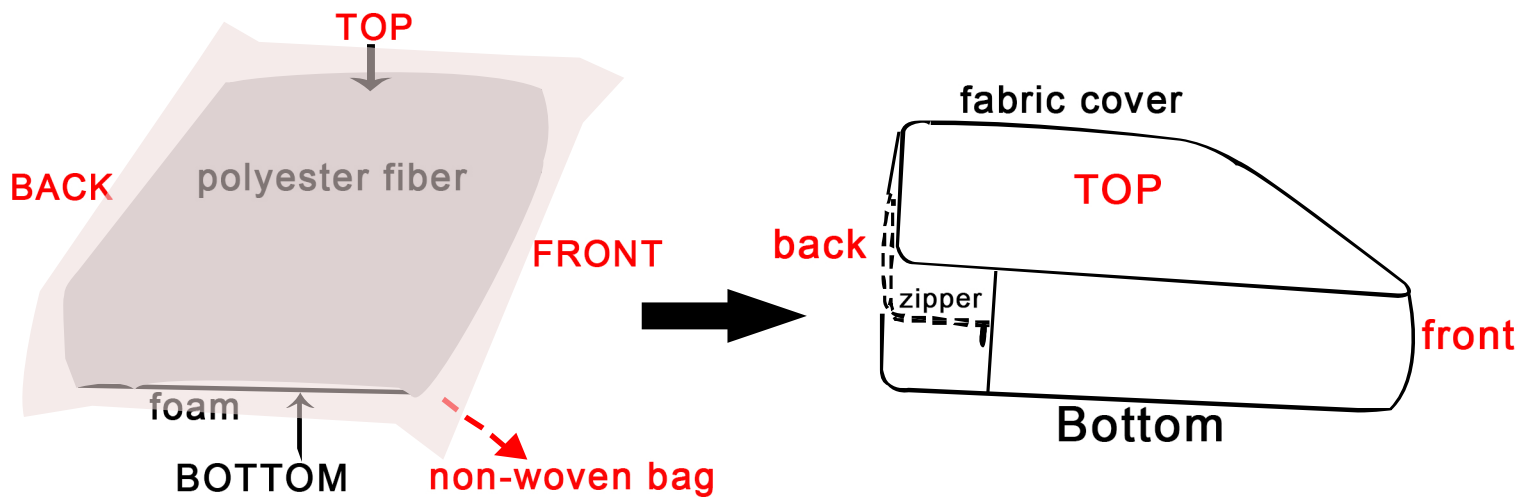

How to tidy sofa seat cushion?



TIPS

At the beginning all cushions are a little loose which is normal. Please allow at least 72 hours for all cushions foam to recover to its natural state after covering the fabric covers.