

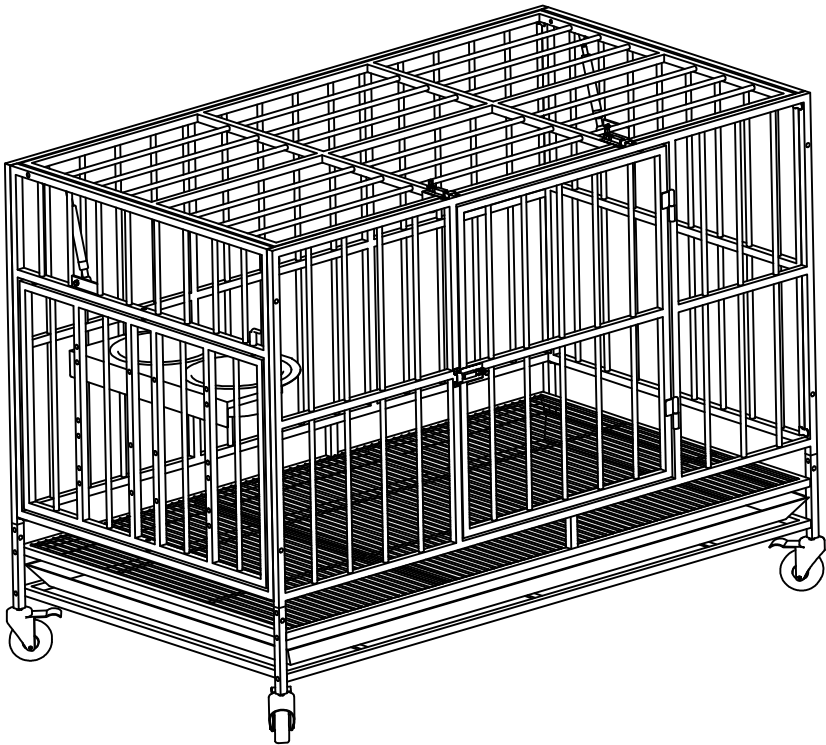













Heavy Duty Dog Cage Kennel Instruction Manual

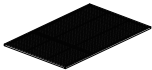

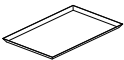











TEL: **(800)209.3199** (MON-FRI 9:00am-5:00pm Eastern Time)
Email: Help@EverythingSupport.com

PARTS LIST

- Carefully remove all the parts from the carton and place them individually on a soft cloth to prevent scratches or other damage.
- Carefully and strictly follow these assembly&installation instructions to ensure a completed product as designed.
- Do not tighten all the screws until each part is properly assembled.

Number	Parts	Quantity
A		1PC
B		1PC
C		1PC
D		1PC
E		1PC
F		1PC
G		1PC
H		1PC
I		1PC
J		2PCS
K		2PCS
L		4PCS
M		4PCS
N		2PCS

Number	Parts	Quantity
①	 M6*25	20PCS
②	 M6*40	2PCS
③	 M6*22	14PCS
④	 M5*15	4PCS
⑤	 M8	2PCS
⑥	 M6	10PCS
⑦	 M6	6PCS
⑧	 M4	1PC
⑨	 10-10	1PC
⑩	 12-12	1PC
⑪	 14-14	1PC
⑫	 Phillips head screwdriver	1PC

DOG CRATE ASSEMBLY

STEP 1

Use labeled (1)(8) to screw (A) to (D) and (C) respectively according to the figure, use (8)(9)(3)(6) to tighten the two (M) on A respectively

	①	③	⑥	⑧	⑨
	4PCS	4PCS	4PCS	1PC	1PC
Required Tools	A		1PC		
	C		1PC		
	D		1PC		
	M		2PCS		

NOTE:
The one with the little round end faces in.

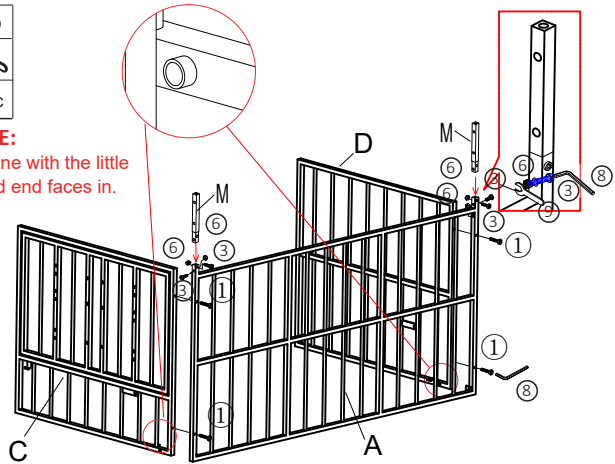

STEP 2

Use labeled (1)(8) to screw (B) to (D) and (C), use (8)(9)(3)(6) to tighten the two (M) on (B) respectively

	①	③	⑥	⑧	⑨
	4PCS	4PCS	4PCS	1PC	1PC
Required Tools	B		1PC		
	M		2PCS		

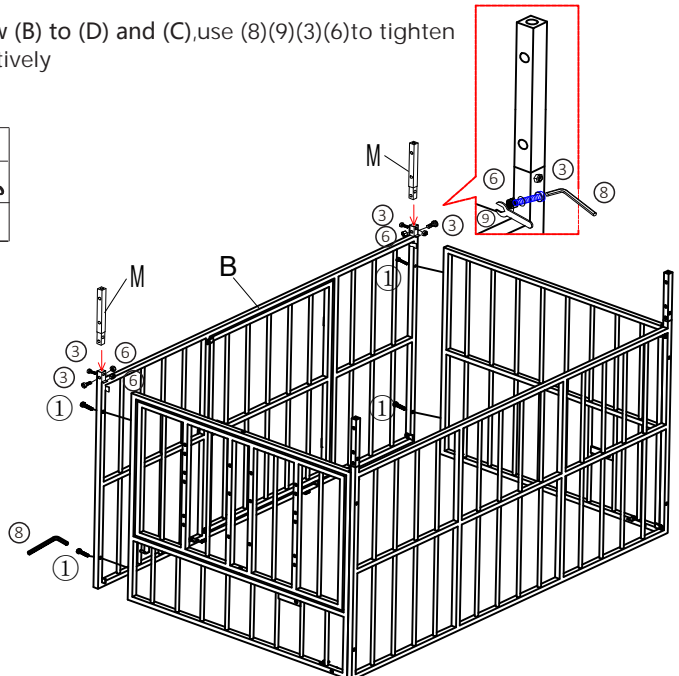

☆ Please pay attention to the hole position in the picture and screw it in vertically

STEP 3

Use (1)(8) to screw the two (N) according to the picture

Required Tools	①	⑧
	2PCS	1PC
	N	
		2PCS

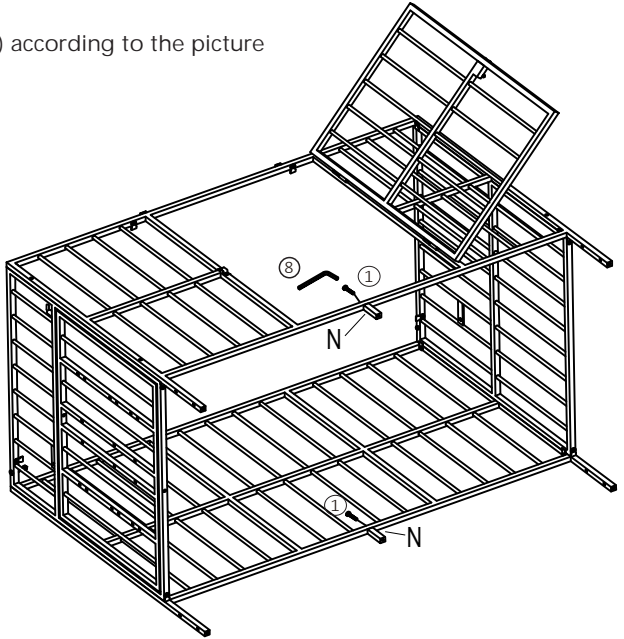

STEP 4

Put (F) into the dog cage from the bottom and screw (F) from the four sides with(1) and (8)

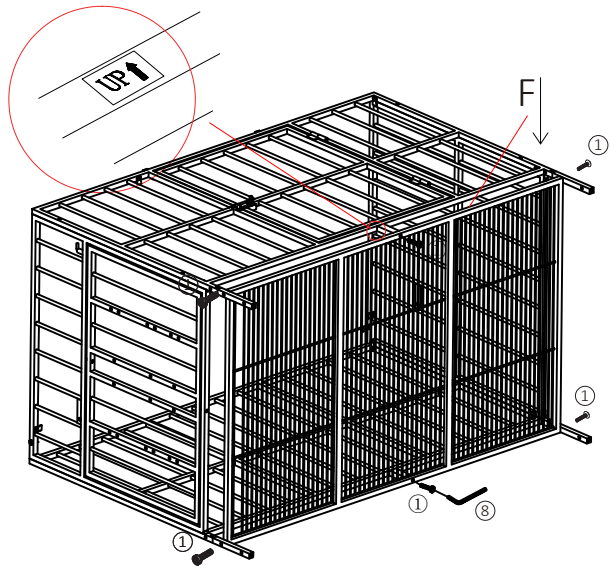

Required Tools	①	⑧
	6PCS	1PC
	F	
		1PC



☆ Please pay attention to the hole position in the picture and screw it in vertically

STEP 5

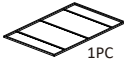

Put (G) into the dog cage from the bottom and screw (G) from the four sides with(1) and (8)

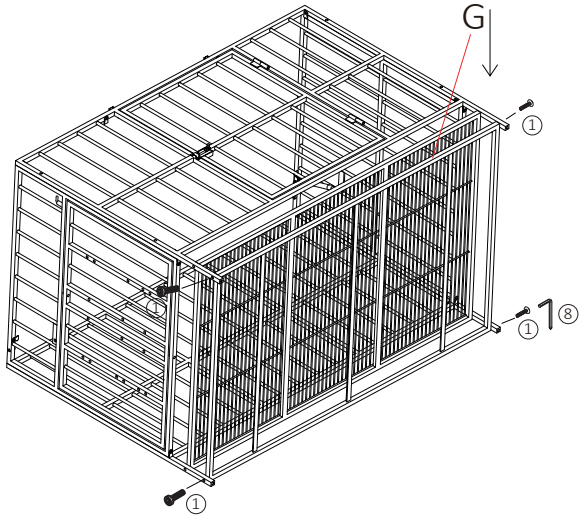
Required Tools	①	⑧	
			
	4PCS	1PC	
	G		1PC



STEP 6

Use (11) to install the four (L) universal wheels on the dog cage from the bottom

Required Tools	⑪		1PC
	L		4PCS

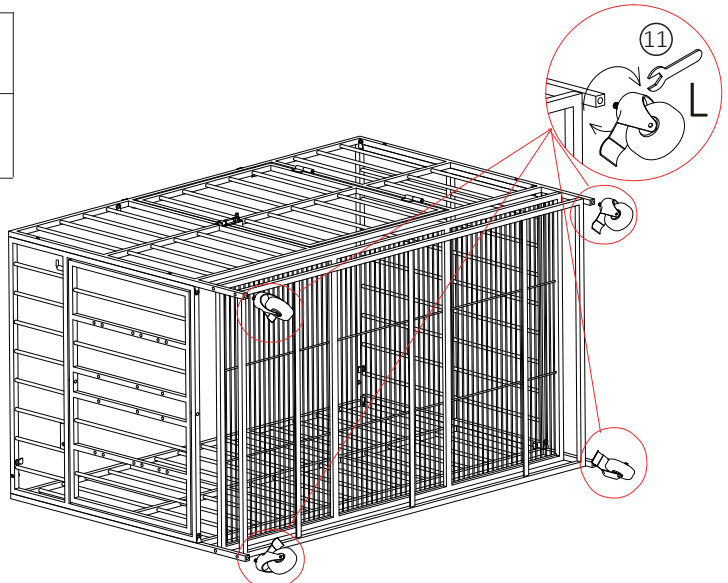

☆ Please pay attention to the hole position in the picture and screw it in vertically

STEP 7

Use (4) (12) to install (K) to (E) as shown in the figure

Required Tools	(4)	(12)
	4PCS	1PC
	E	
		1PC
	K	
		2PCS

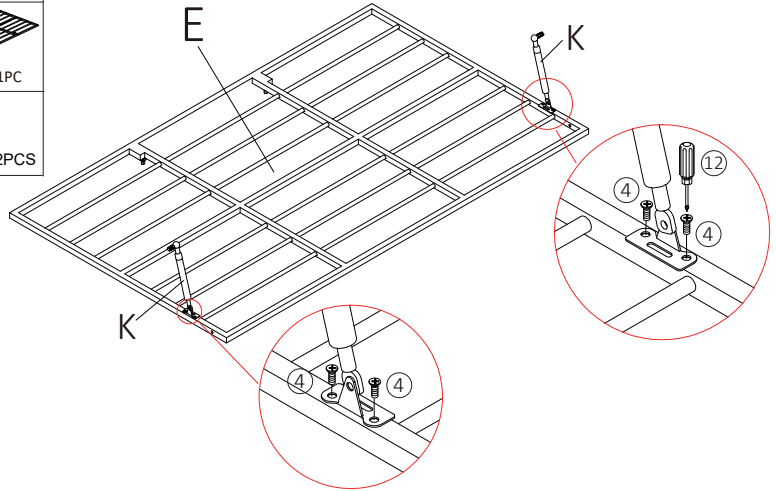

STEP 8

Put (E+K) into the dog cage from the top, and use (2)(6)(8)(9) to screw it from the left and right ends respectively



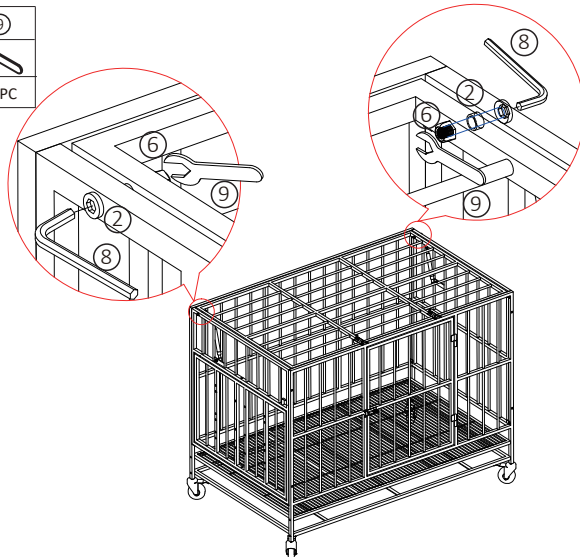

Required Tools	(2)	(6)	(8)	(9)
	2PCS	2PCS	1PC	1PC
	E+K			
				1PC



☆ Please pay attention to the hole position in the picture and screw it in vertically

STEP 9

Use (5)(10)(11) to screw the hydraulic rod from the left and right ends, and then put (H) into the dog cage from the bottom



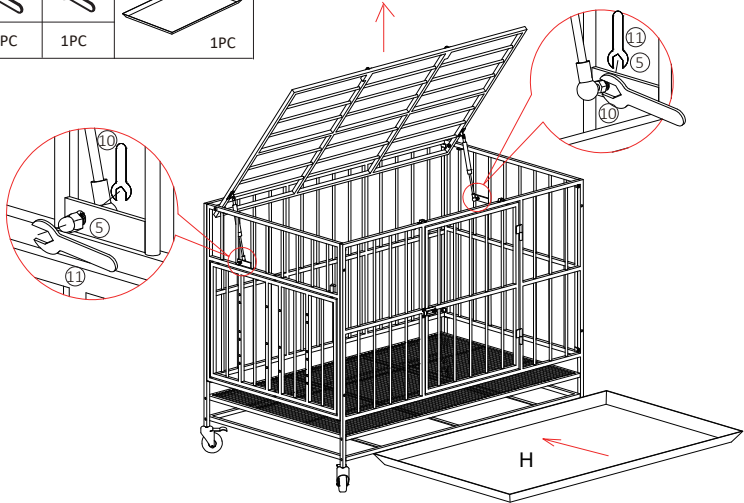

	⑤	⑩	⑪	H
Required Tools				
	2PCS	1PC	1PC	1PC



STEP 10

Use tools (3)(7)(8)(9) to screw the dog feeding tray (I) to the (C) iron frame. You can measure the height of the dog according to the method shown in the figure and then select the corresponding installation height of the dog feeding tray

1. Measure your dog from the floor to the highest point of their shoulder blades.
2. Match your dog's measurement to the feeder height on the chart.

	③	⑦	⑧	⑨	I
Required Tools					
	6PCS	6PCS	1PC	1PC	1PC

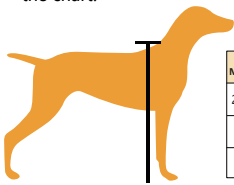

Dog Measurement	Feeder Height
21" & Taller	20"
15" - 20"	14"
10" - 14"	8"

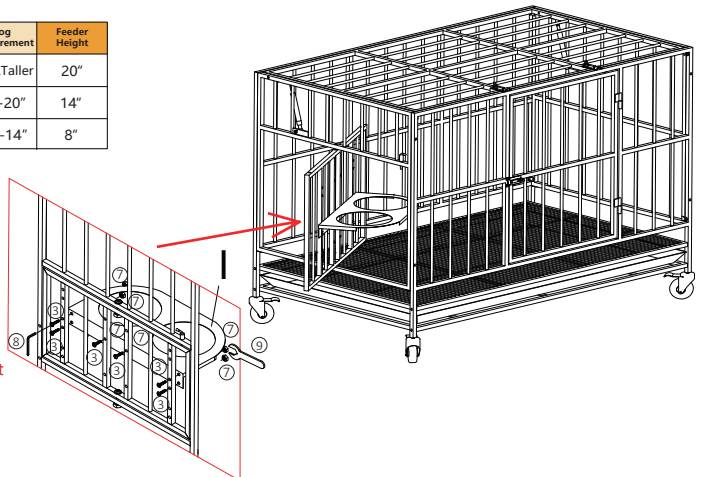

NOTE:

The three pairs of holes are respectively 8 inches, 14 inches and 20 inches from the height of the bottom iron net

☆ Please pay attention to the hole position in the picture and screw it in vertically

STEP 11

Place the dog bowl (J) into the feeding tray.

Required Tools	J
	
	2PCS

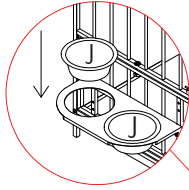

NOTE:

Pull the latch up to open the dog feeding tray that can rotate freely 360 degrees, align the latch with the hole on the tray and insert it to lock

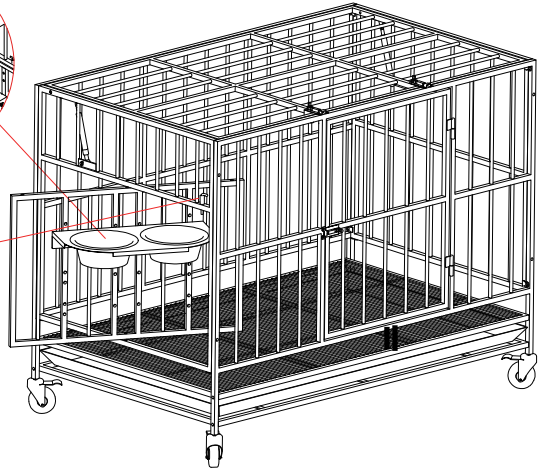

STEP 12

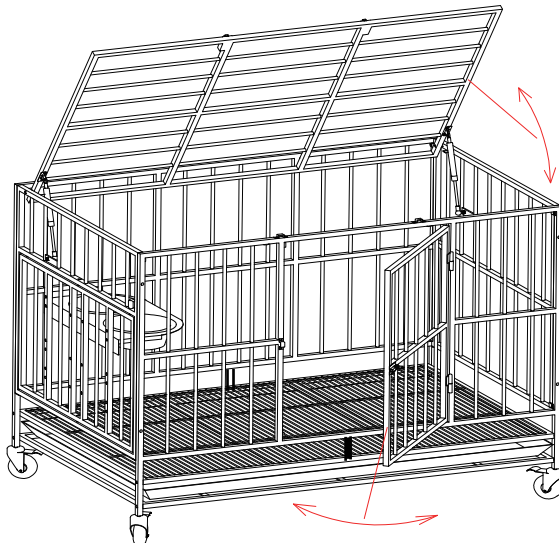

☆ Please pay attention to the hole position in the picture and screw it in vertically

AFTER-SALES SERVICE CARD

We sincerely thank you for trusting our service and our products, and may this product add enrichment to your home. We guarantee that the product has undergone strict quality inspection and meticulous packaging. If you encounter any issue regarding either shipping or the product, please feel free to contact us at any time. We'd be more than happy to serve you wholeheartedly.
Yours Sincerely

***Customer Service:(800)209.3199(MON-FRI 9:00am-5:00pm
Eastern Time) or contact Help@EverythingSupport.com***

Address: 3005 Breckinridge Blvd, Suite 200, Duluth, GA 30096

If you have any questions or concerns please feel free to contact us. We're committed to providing our customers with the quality service.