

ASSEMBLY INSTRUCTION

BED HOUSE WITH TRUNDLE

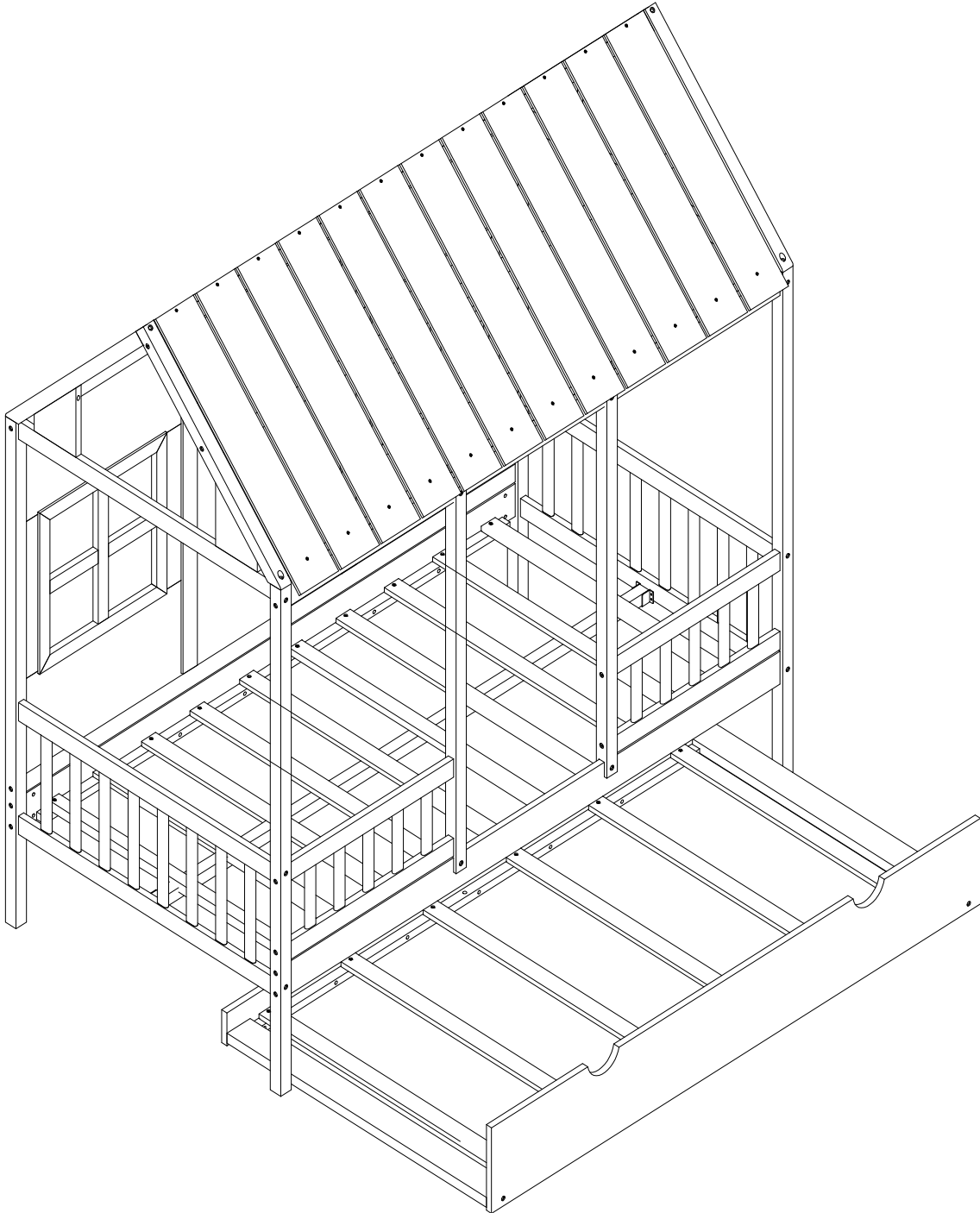







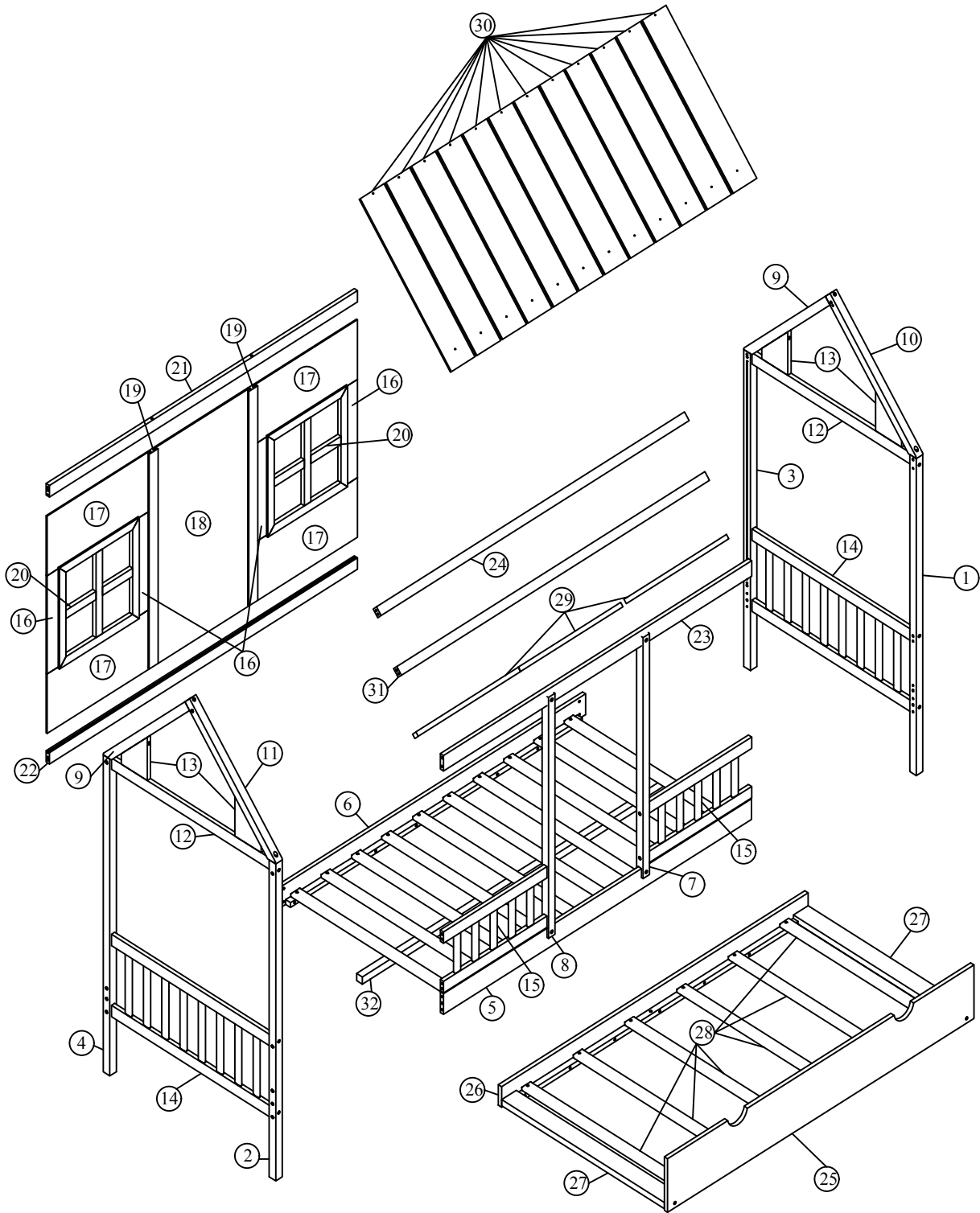



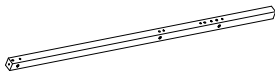
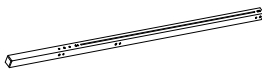

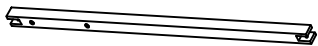

This set included 2 boxes if don't receive full 2 boxes please contact our customer service team.

WF304133/34

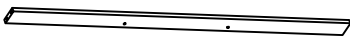
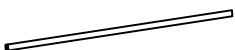

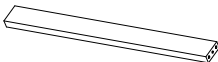
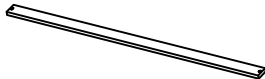













Detail view:









Part List (WF304134)

1	 Leg front right - 1pc	2	 Leg front left - 1pc	3	 Leg back right - 1pc
4	 Leg back left - 1pc	5	 Front bed shoulder - 1pc	6	 Back bed shoulder - 1pc
7	 Quiz standing front right - 1pc	8	 Quiz standing front left - 1pc	9	 Right left rear roof - 2pcs
21	 Crossbar upper back - 1pc	22	 Crossbar lower back - 1pc	23	 Crossbar lower front - 1pc
24	 Qui across the roof - 1pc	25	 Drawer panels - 1pc	26	 Backboard pull drawer - 1pc
27	 Drawer horizontal bar - 2pcs	28	 Slat trundle - 6pcs	31	 Roof board support top- 1pcs
32	 Long Support Slats			33	 Slat - 10pcs

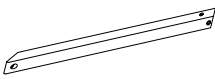
Hardware List

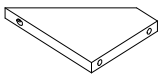
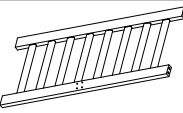
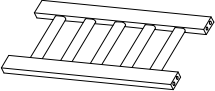
A	 Ø10*20mm Wood dowel (60pcs)	B	 M6*88mm Hex - Head bolt (8pcs)	C	 M6 Horizontal - Hole bolt (8pcs)
D	 M6*60mm Hex - Head bolt (32pcs)	E	 M6*35mm Hex - Head bolt (10pcs)	F	 Ø10*20mm Metal base (2pcs)
G	 M6*15mm Hex - Head bolt (4pcs)	H	 M6-Ø13-1mm Flat Washer (54pcs)	I	 Wheel (4pcs)
J	 100*60*2mm Metal Plate (1pc)	K	 #4*50mm Screw (8pcs)	L	 #4*35mm Screw (16pcs)
M	 #4*25mm Screw (56pcs)	N	 #4*20mm Screw (16pcs)	O	 K4mm Allen key (1pc)
P	 M8*30-Ø25*10mm Leveler (2pcs)	ASSEMBLY TOOLS REQUIRED (NOT INCLUDED) 			

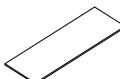
Part List (WF304133)

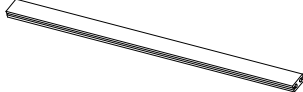
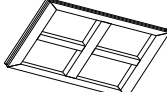
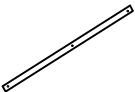
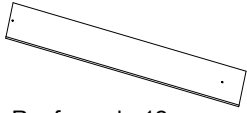
<p>10</p>  <p>Quiz the roof right front- 1pc</p>	<p>11</p>  <p>Quiz the roof left front - 1pc</p>	<p>12</p>  <p>Side frame top rail - 2pcs</p>
<p>13</p>  <p>Side frame decoration - 4pcs</p>	<p>14</p>  <p>Side frame - 2pcs</p>	<p>15</p>  <p>Front frame - 2pcs</p>
<p>16</p>  <p>Back panel 1 - 4pcs</p>	<p>17</p>  <p>Back panel 2 - 4pcs</p>	<p>18</p>  <p>Between Back panel - 1pc</p>
<p>19</p>  <p>Quiz standing back frame - 2pcs</p>	<p>20</p>  <p>Window frame - 2pcs</p>	<p>29</p>  <p>Roof board support bottom -3pcs</p>
<p>30</p>  <p>Roof panel - 12pcs</p>		

STEP 1:

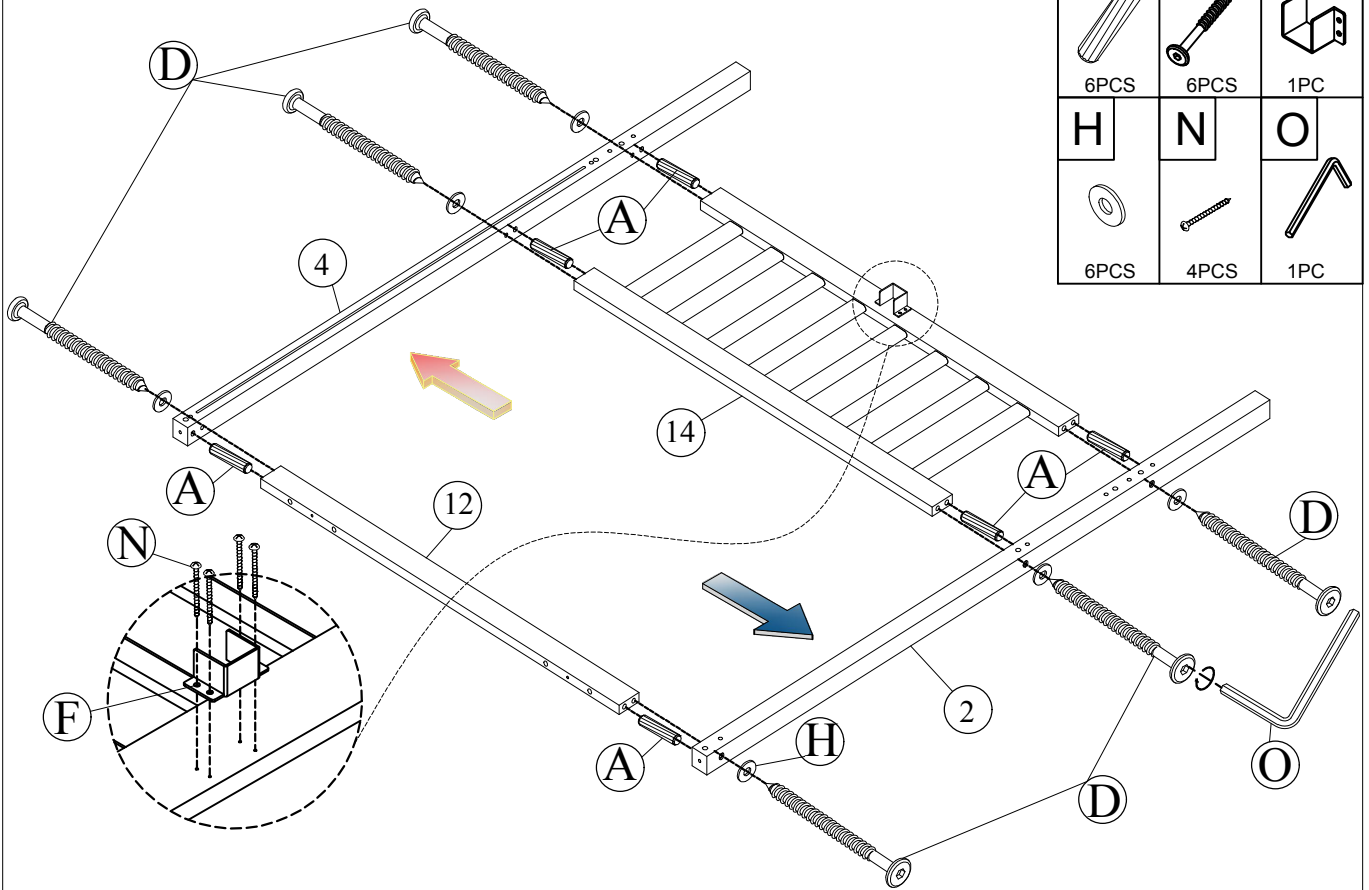

STEP 2:

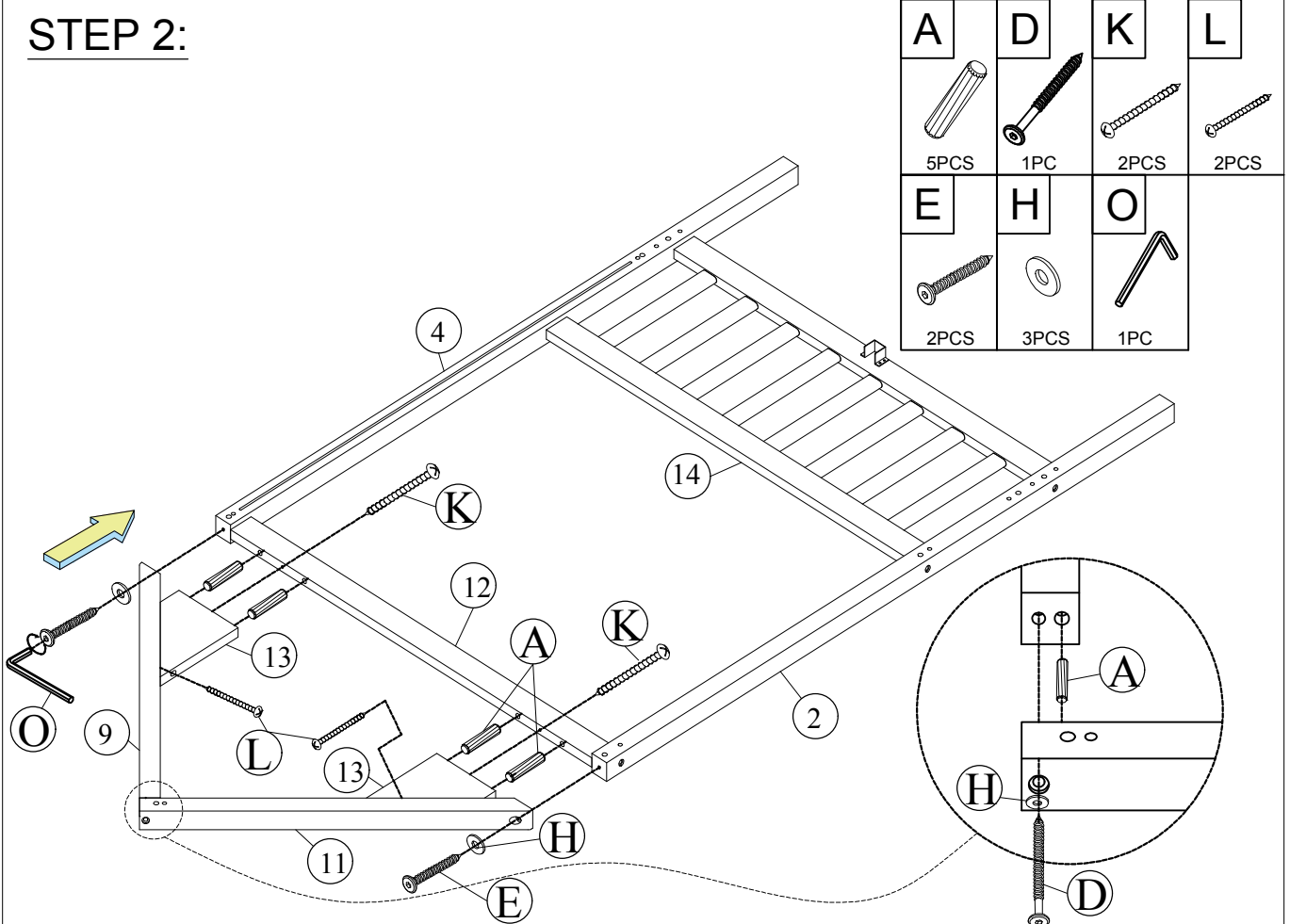

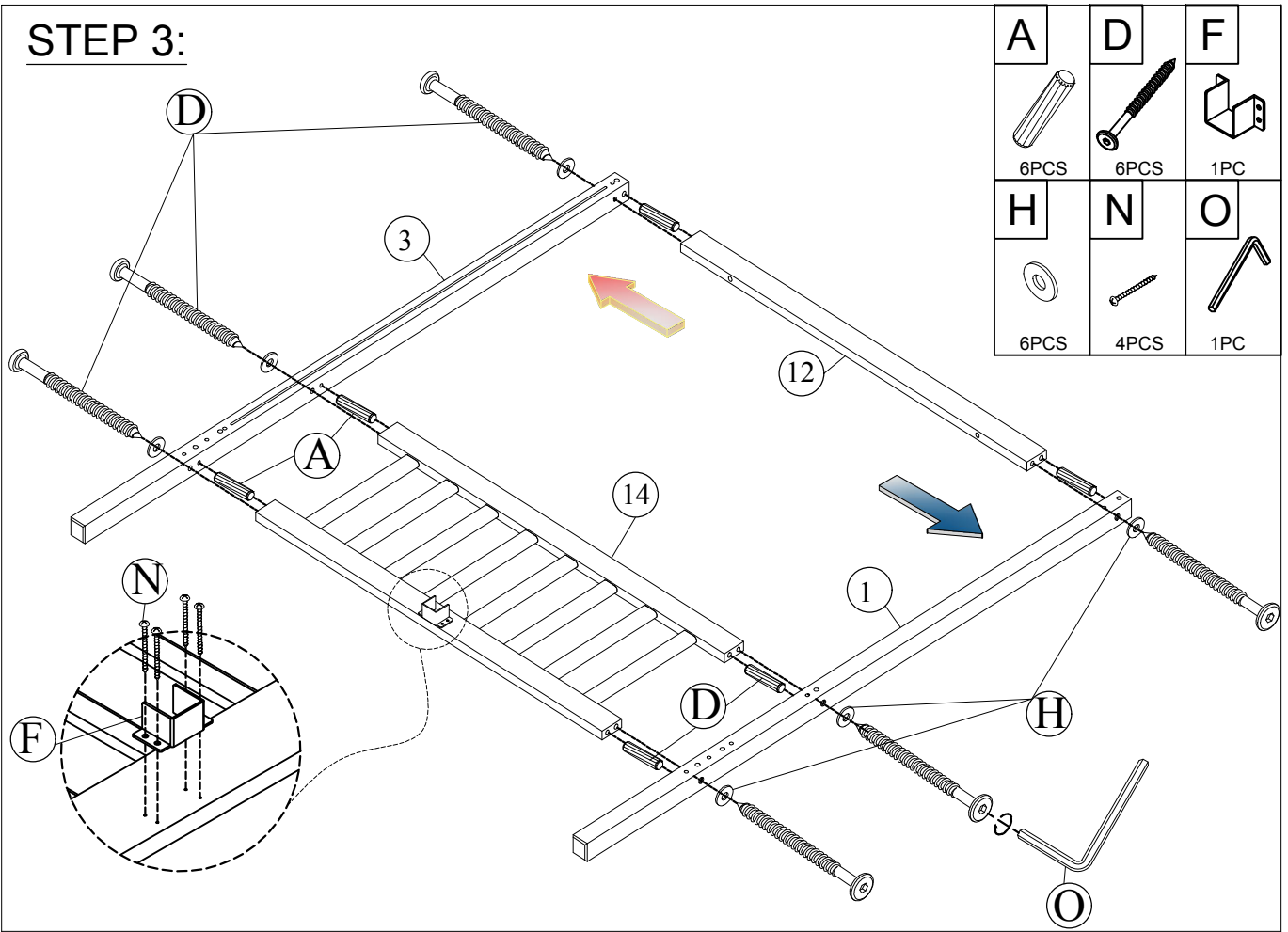

STEP 3:

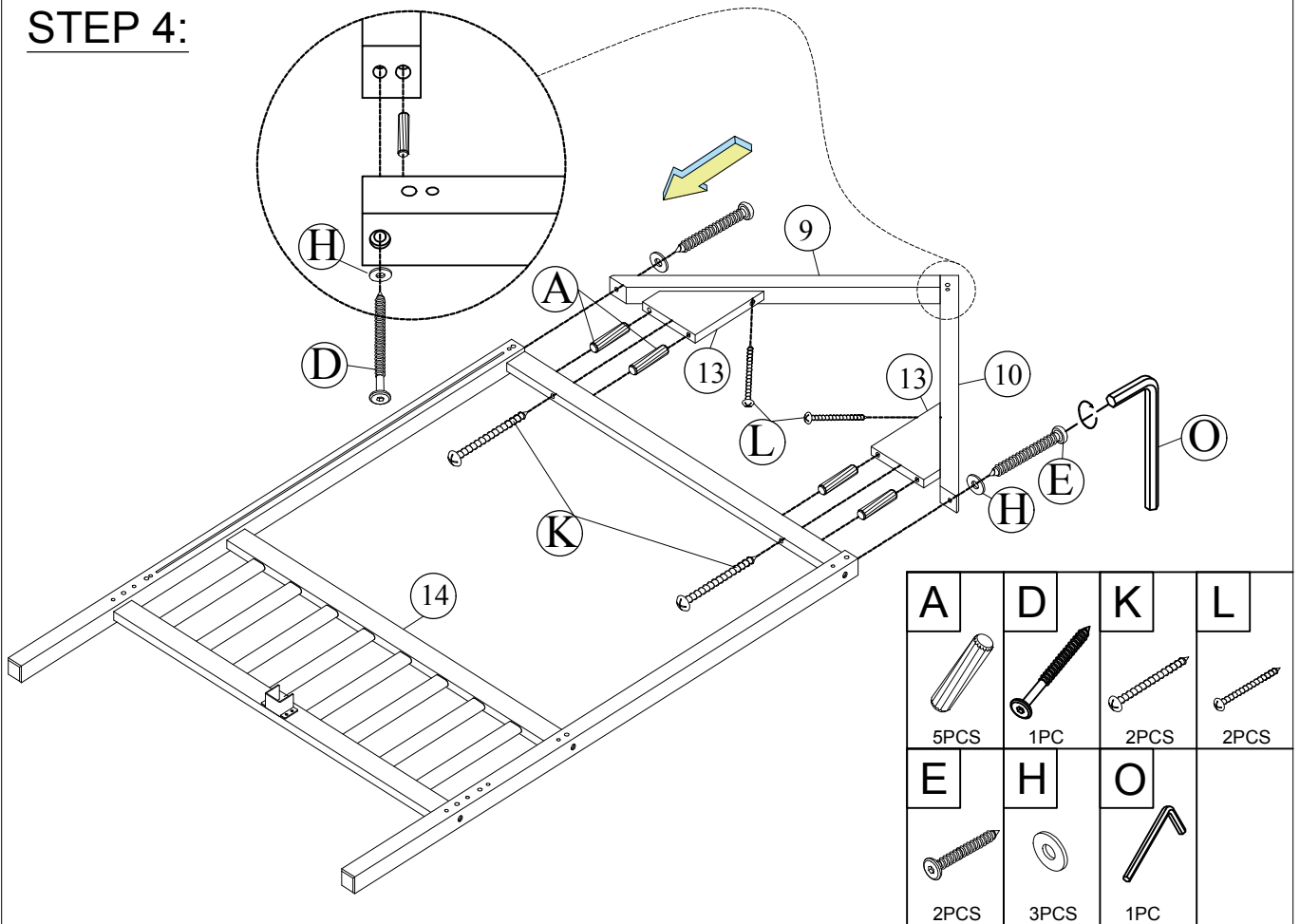

STEP 4:



STEP 5:



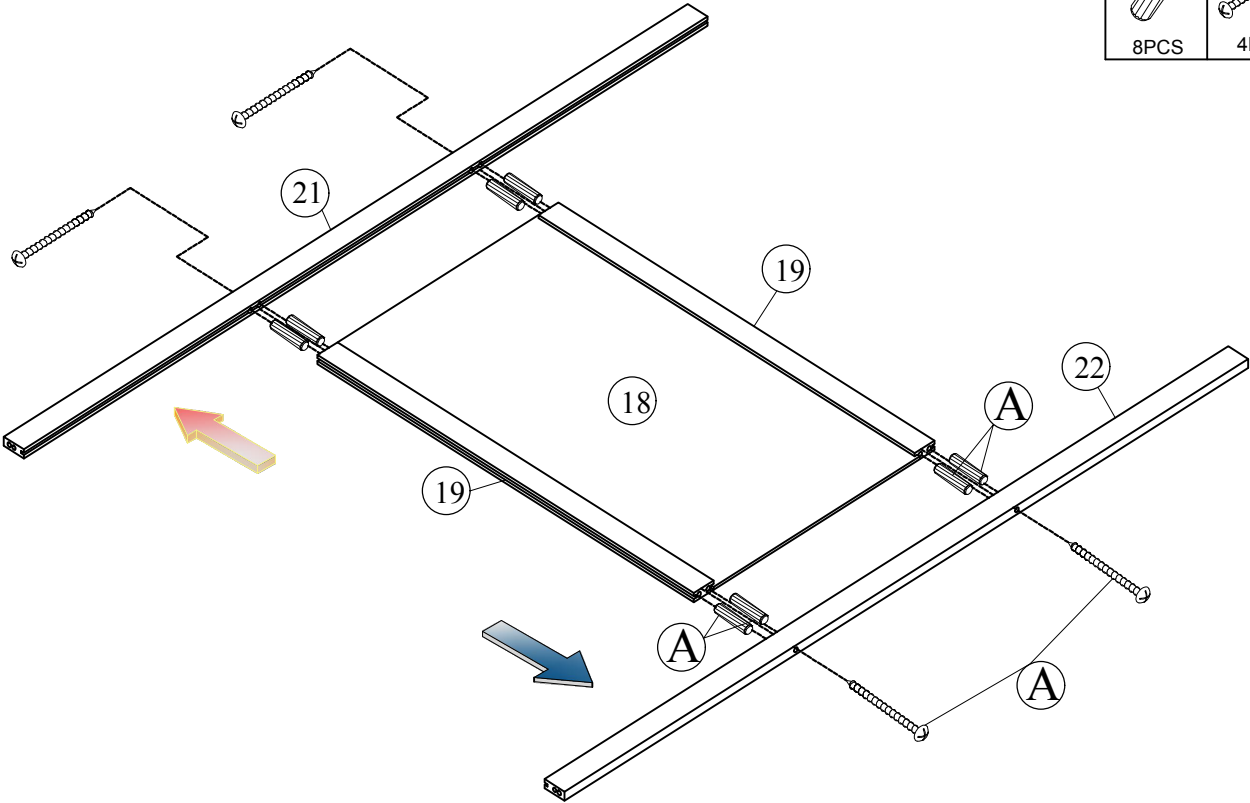

A	K
	
8PCS	4PCS

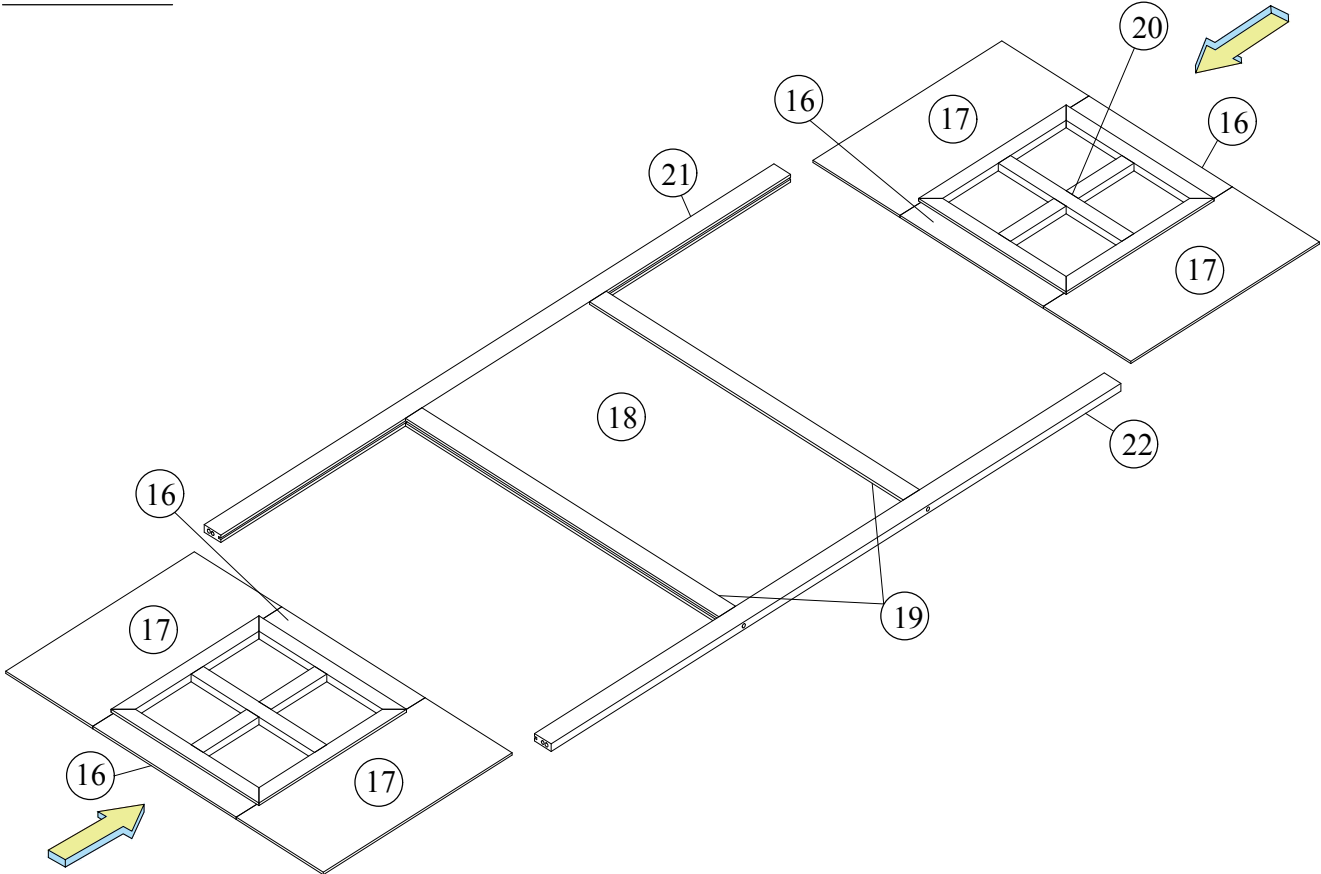

STEP 6:





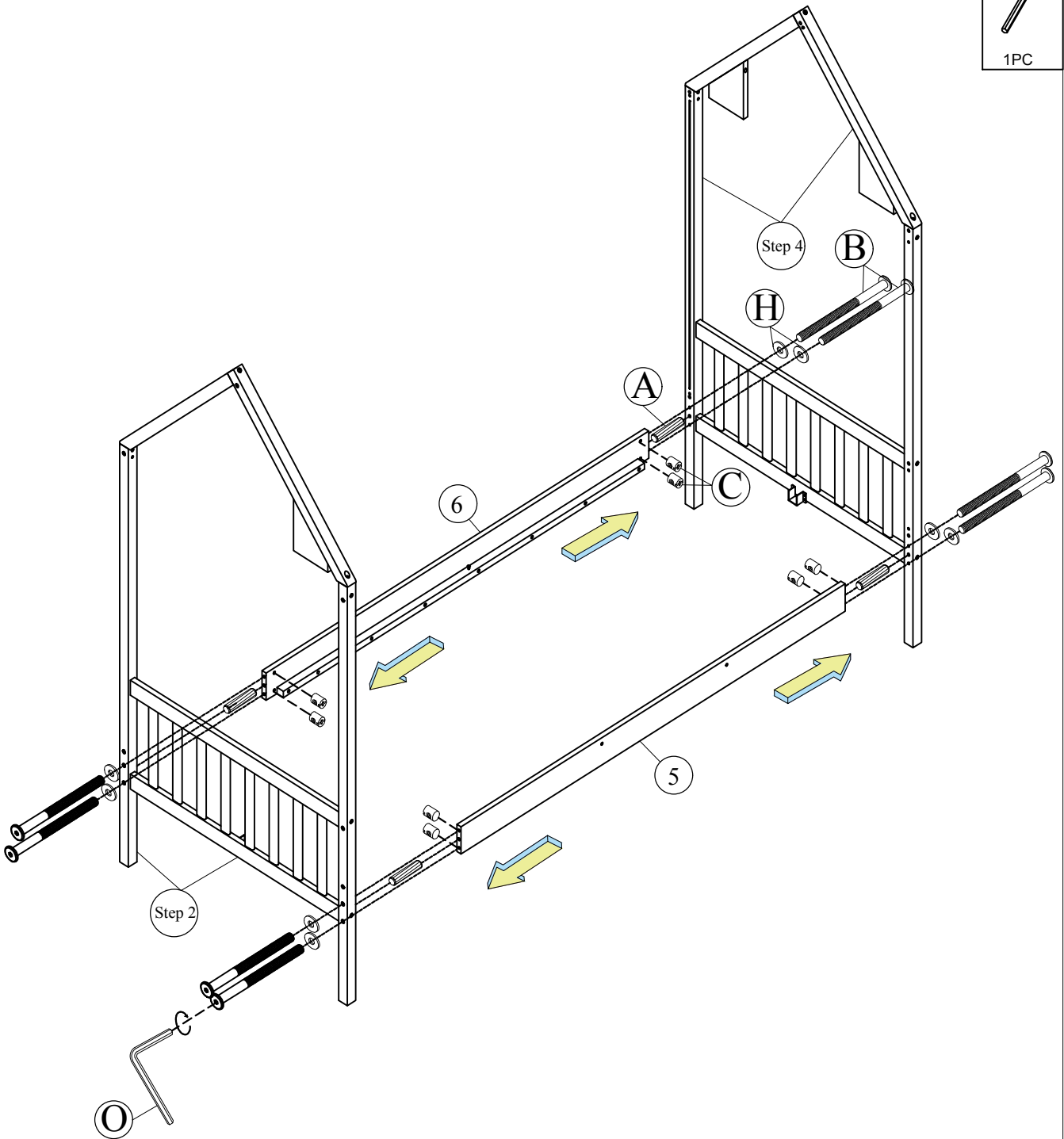

STEP 7:

A  4PCS	B  8PCS	C  8PCS	H  8PCS
O  1PC			





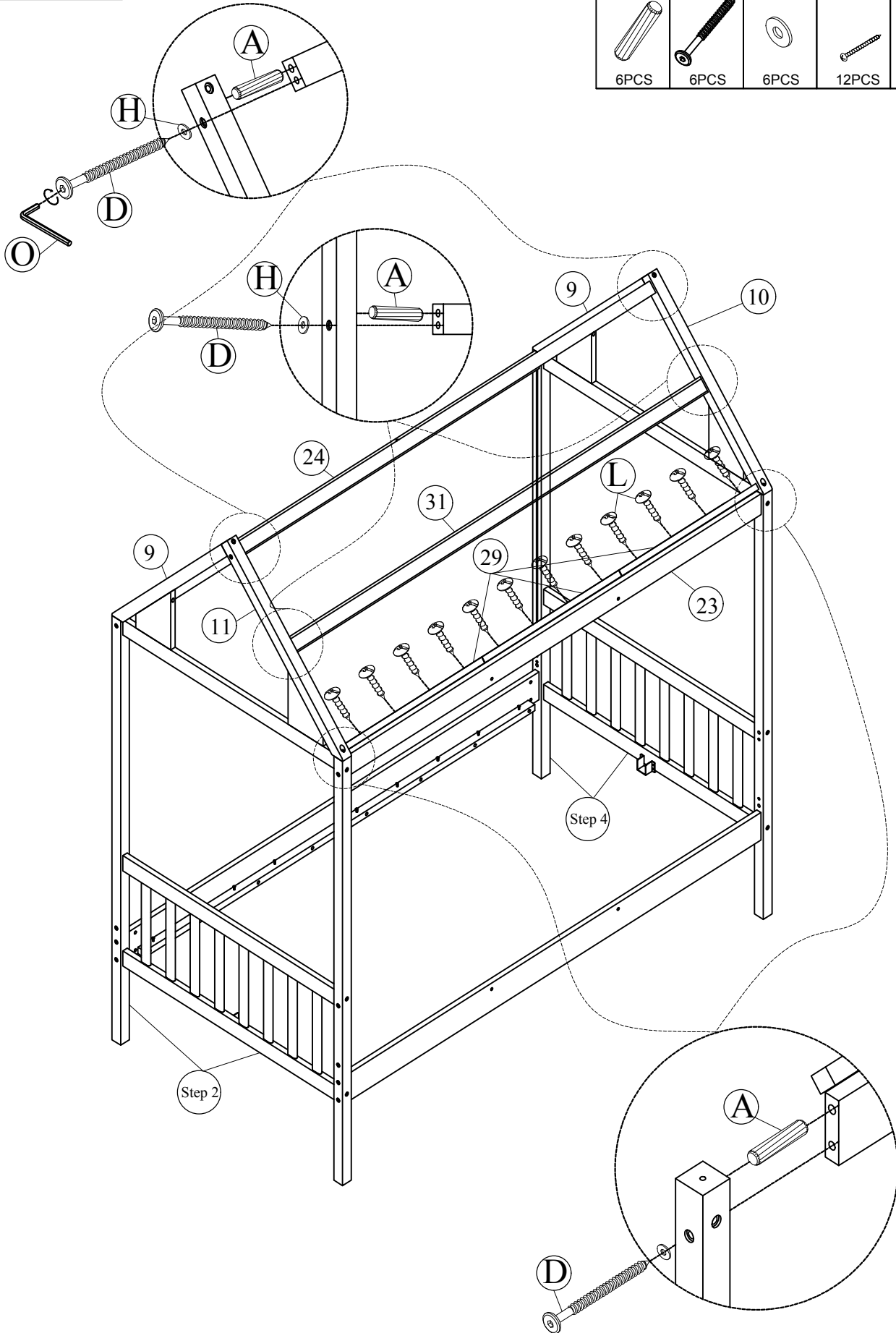

Note :
Do not lock the bolt.

STEP 8:

A	D	H	L	O
				
6PCS	6PCS	6PCS	12PCS	1PC



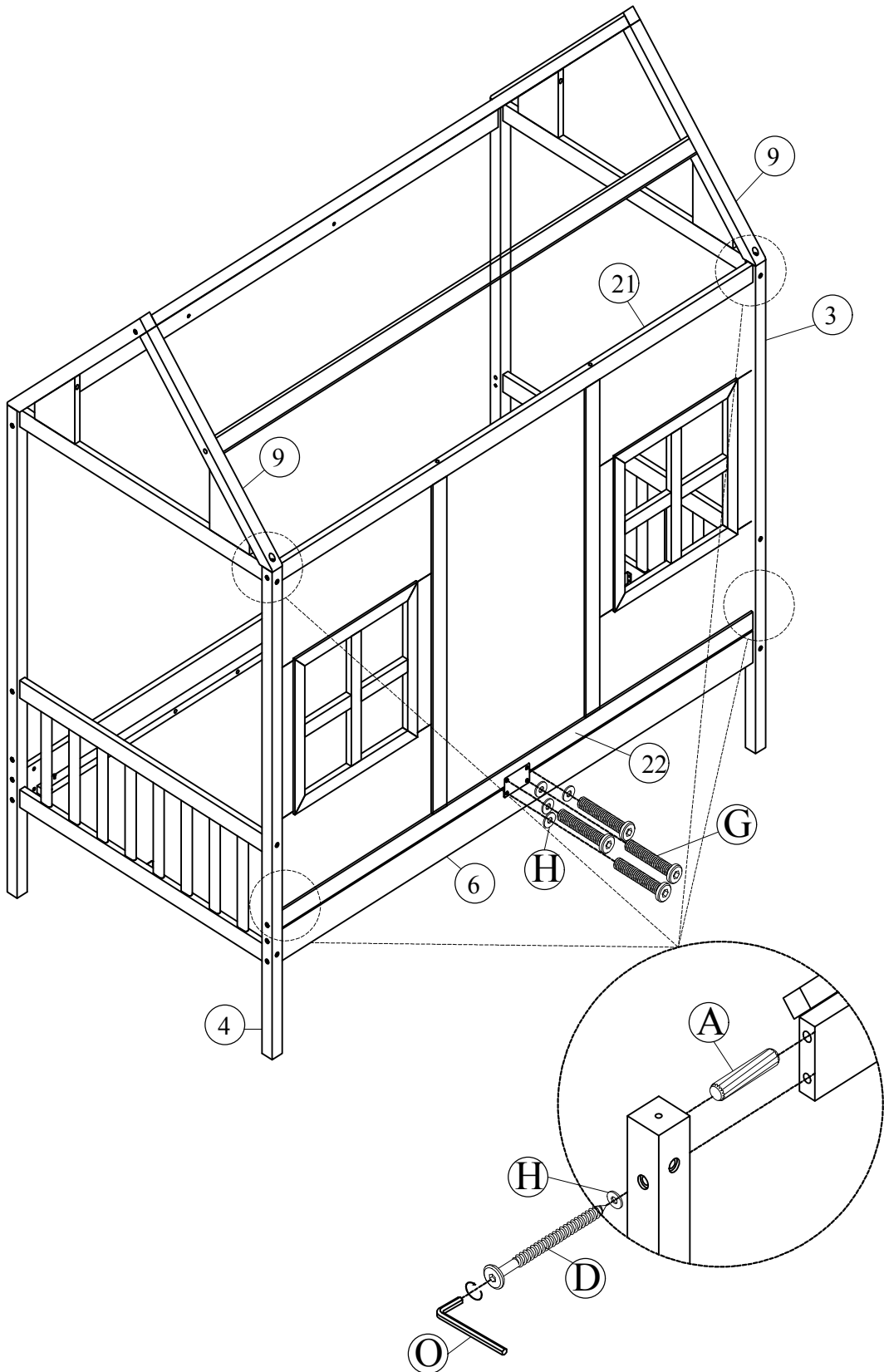

STEP 9:

A  4PCS	D  4PCS	H  10PCS	G  4PCS	O  1PC
--	---	--	---	--



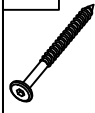

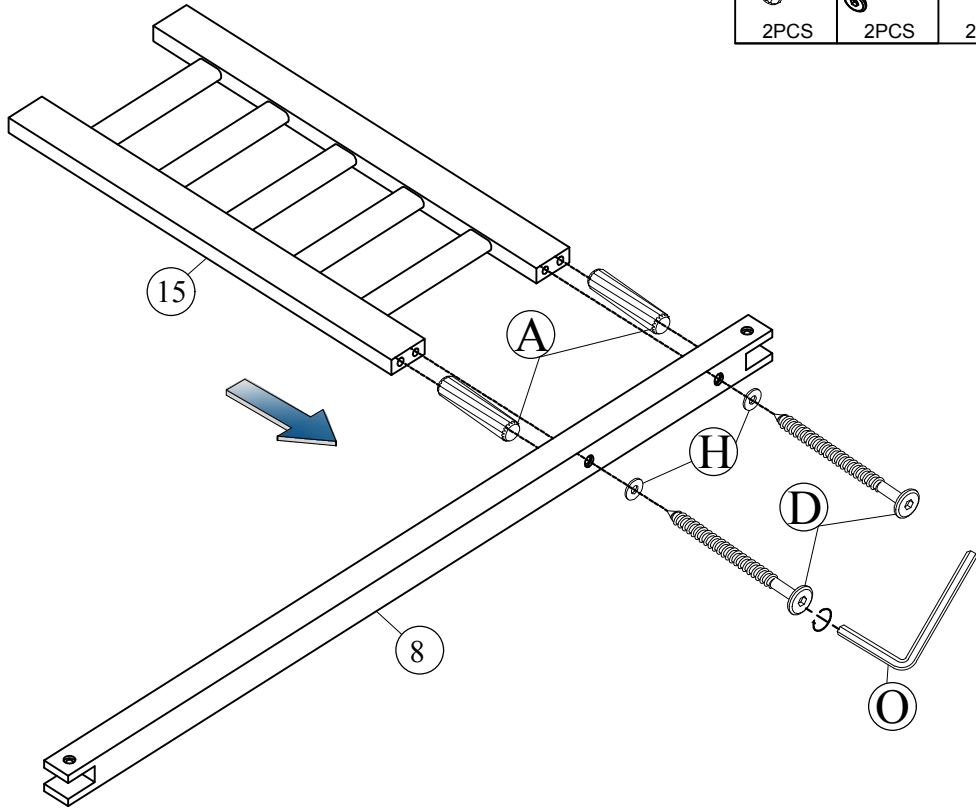

STEP 10:

A	D	H	O
			
2PCS	2PCS	2PCS	1PC



STEP 11:

A	D	H	O
			
2PCS	2PCS	2PCS	1PC

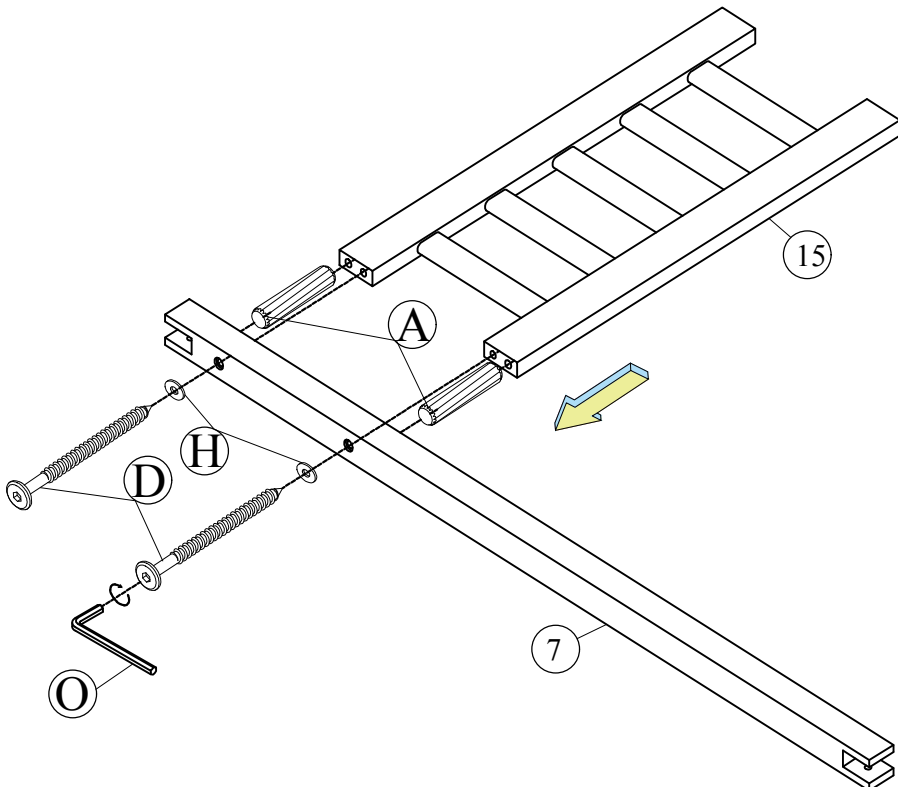



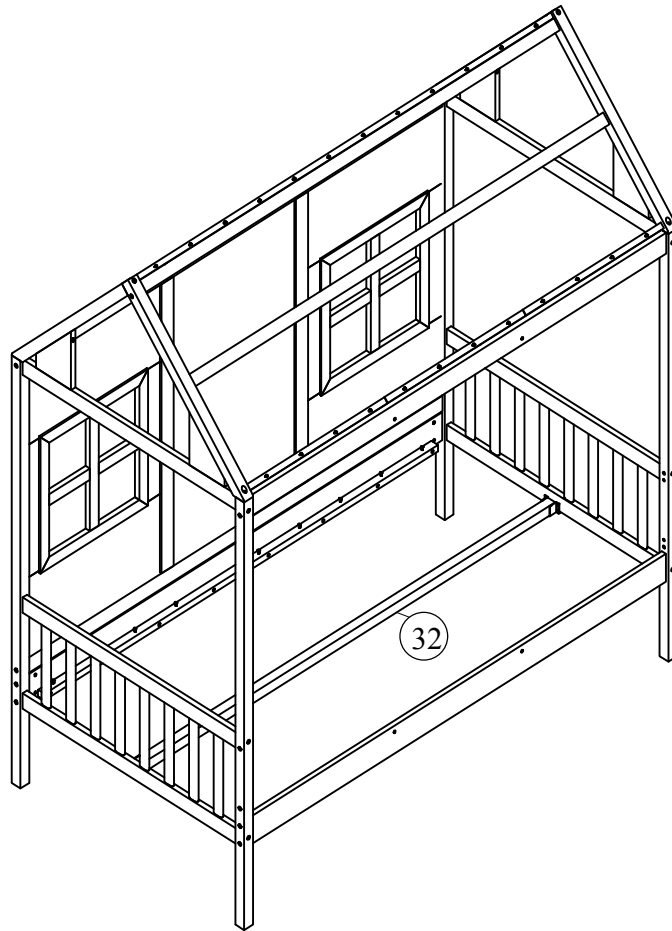

STEP 12:

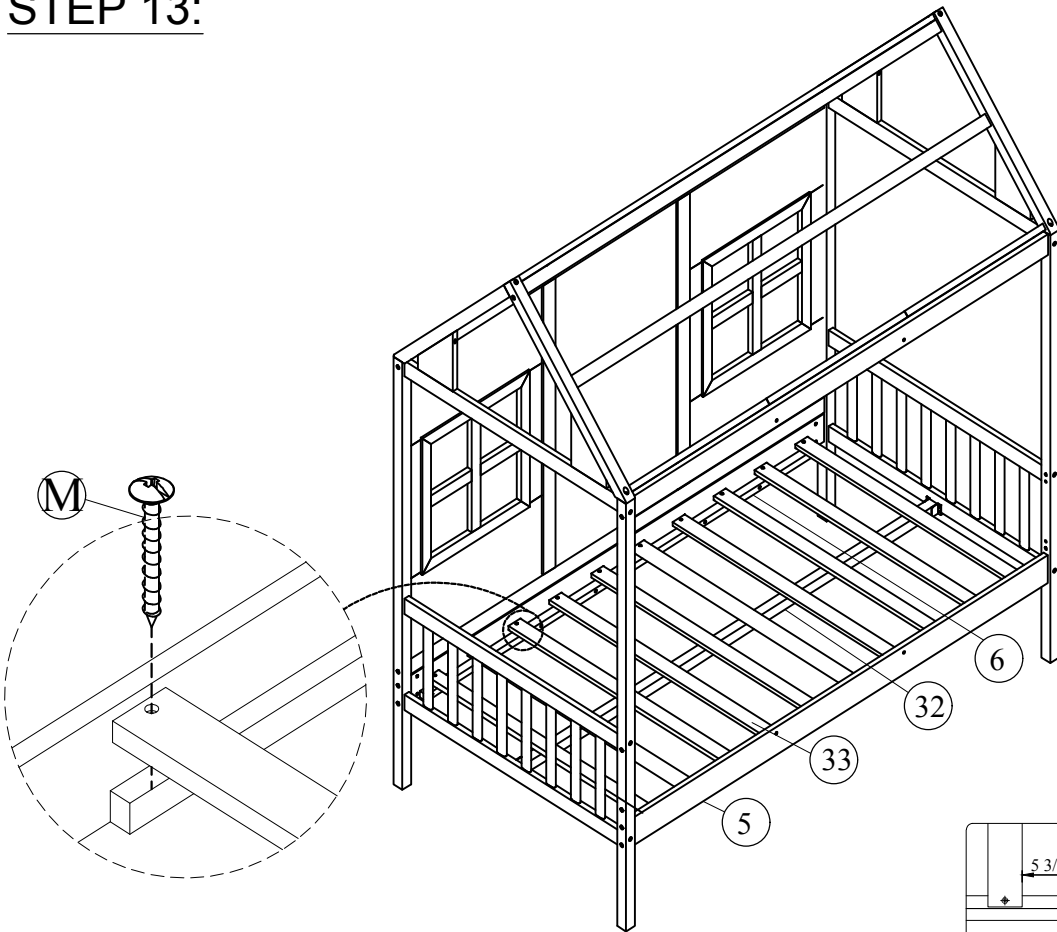
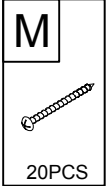

STEP 13:



STEP 14:

A	D	E	H	O
				
4PCS	4PCS	2PCS	6PCS	1PC

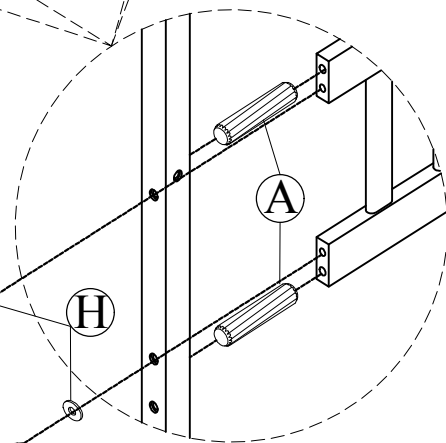
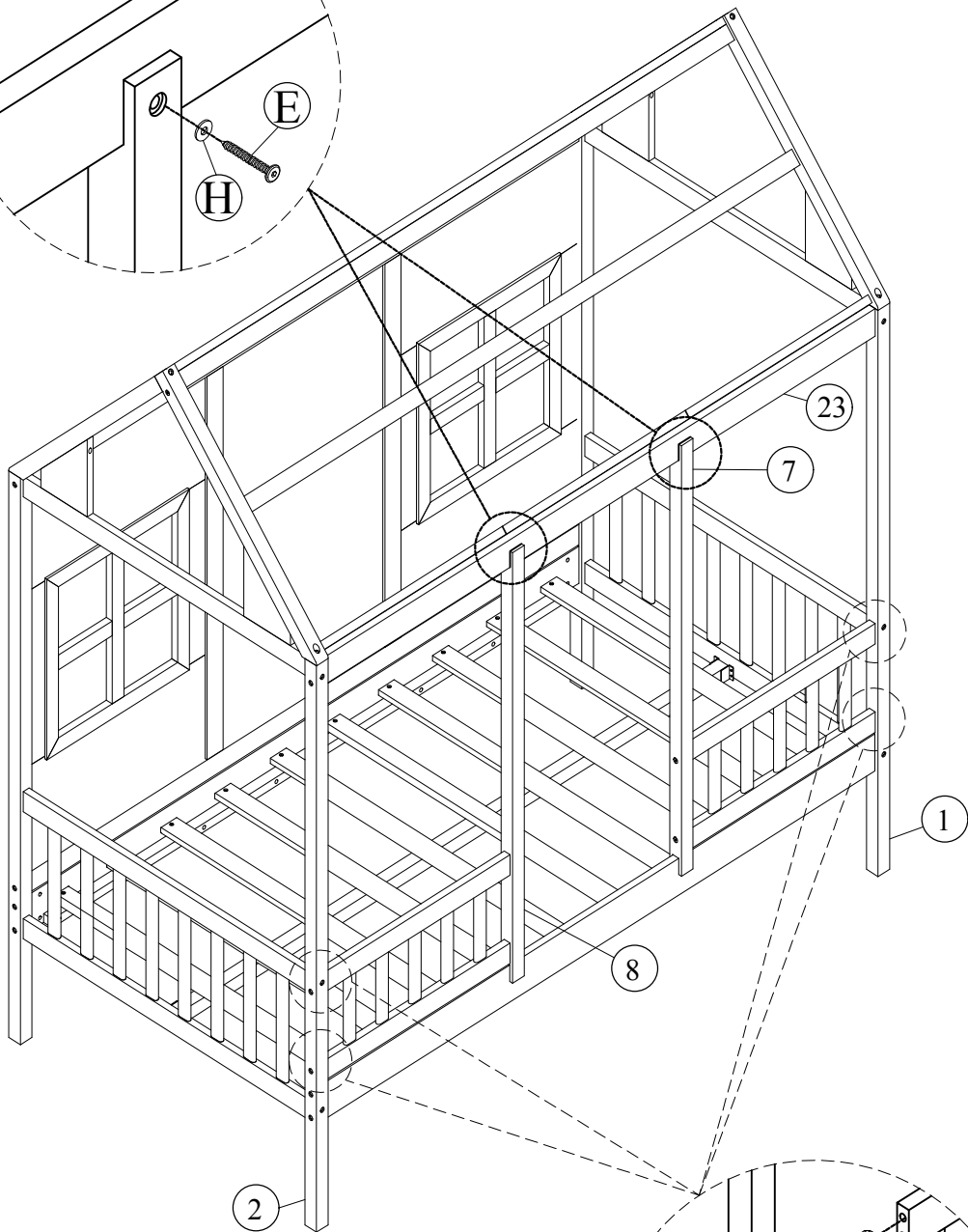
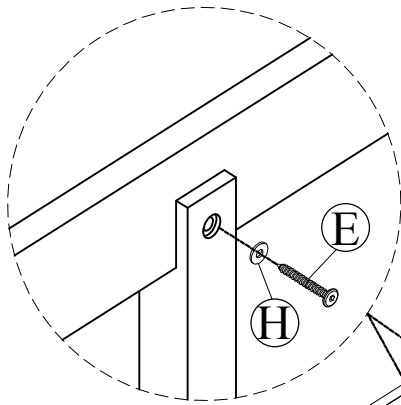

Note :
Lock the bolt.

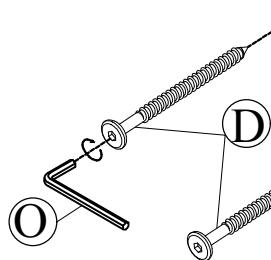

STEP 15:

M



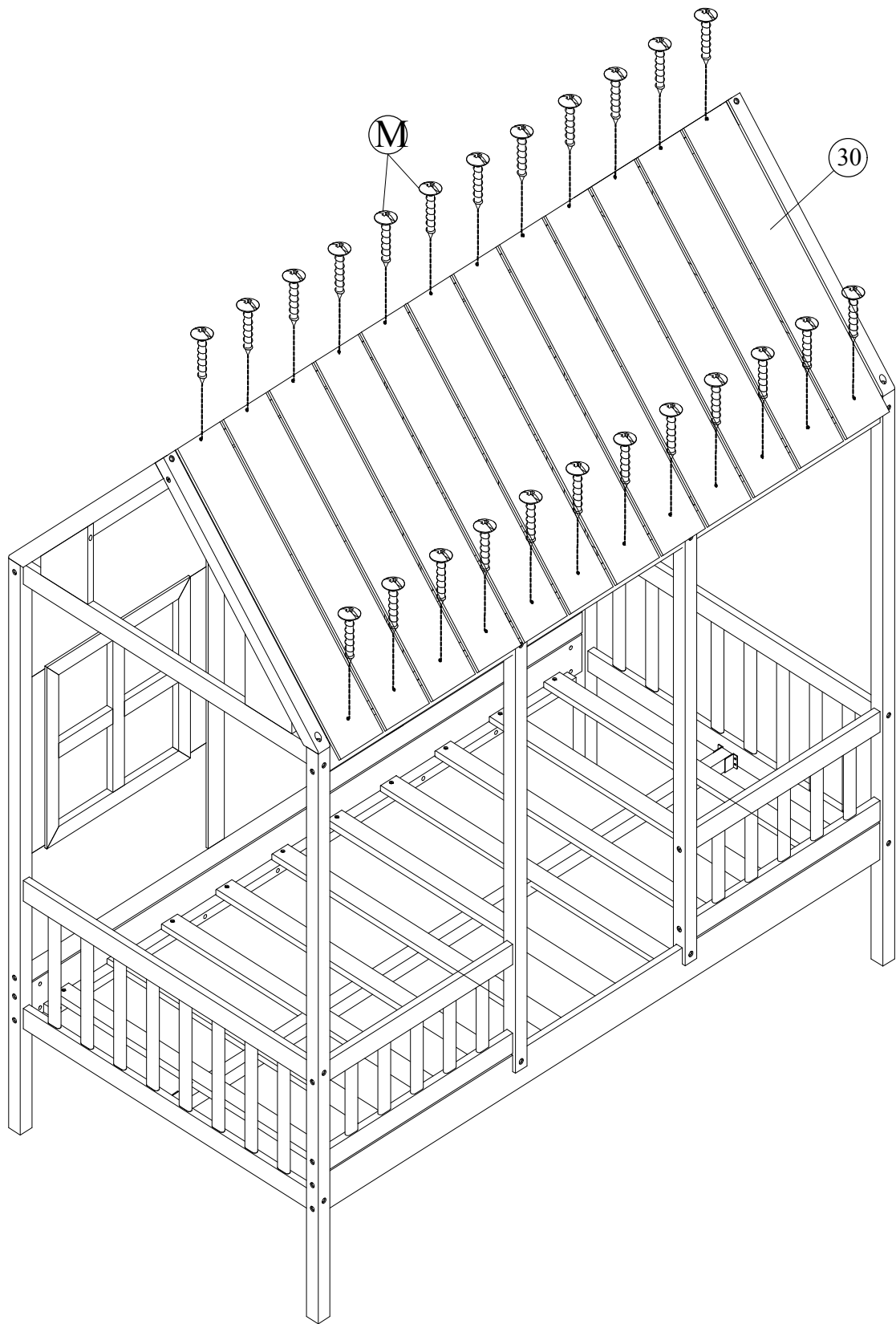

24PCS

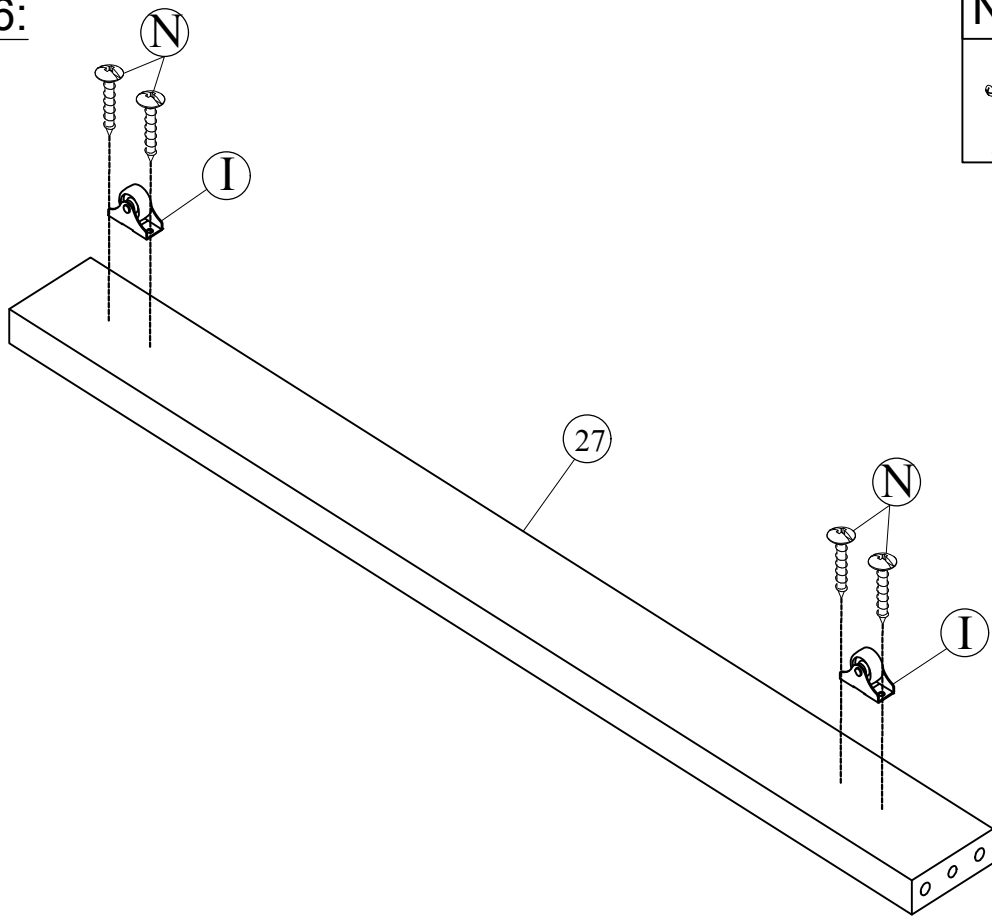

STEP 16:





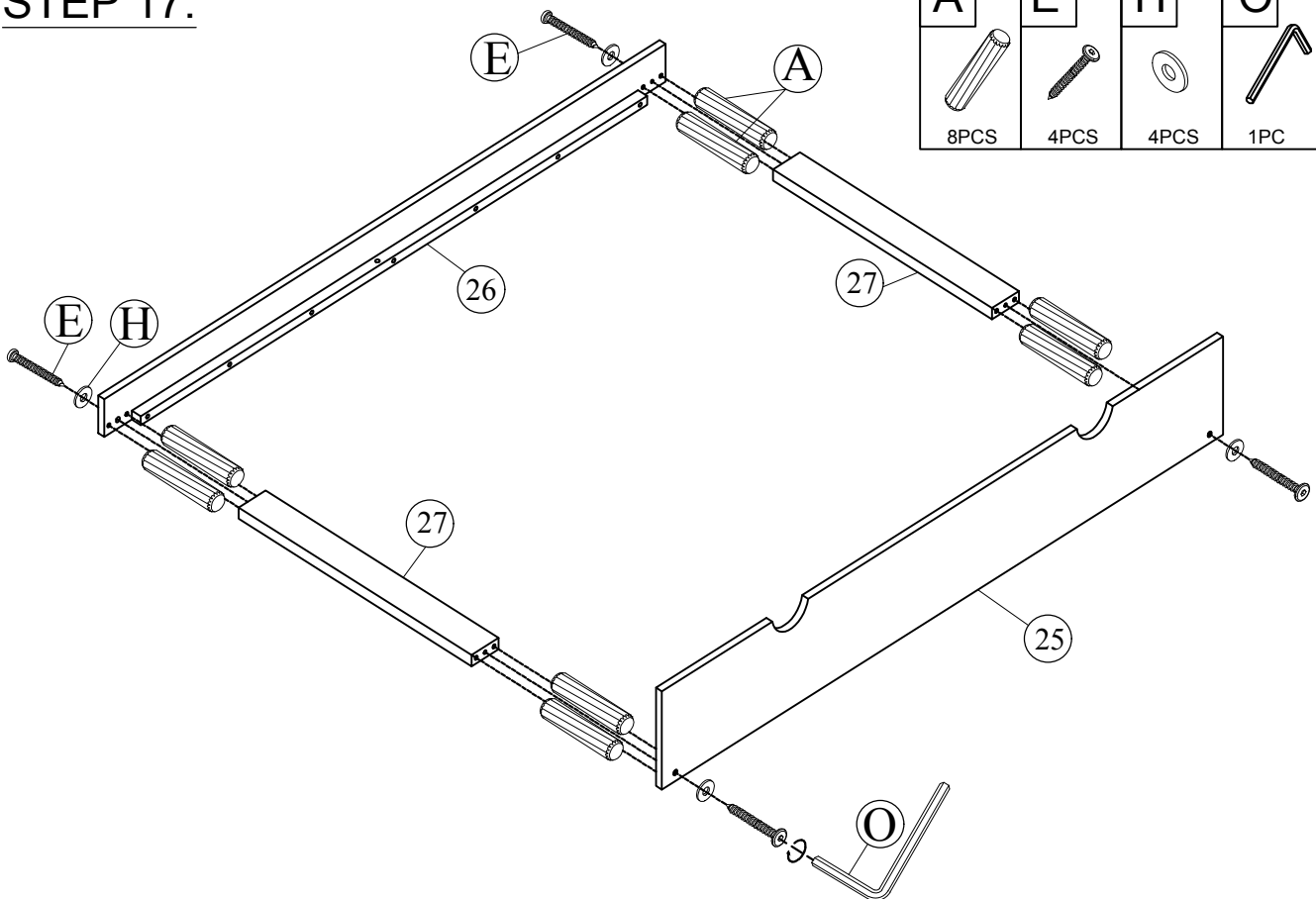

N	I
	
4PCS	4PCS

X2

STEP 17:



A	E	H	O
			
8PCS	4PCS	4PCS	1PC

STEP 18:

M

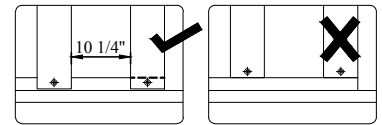
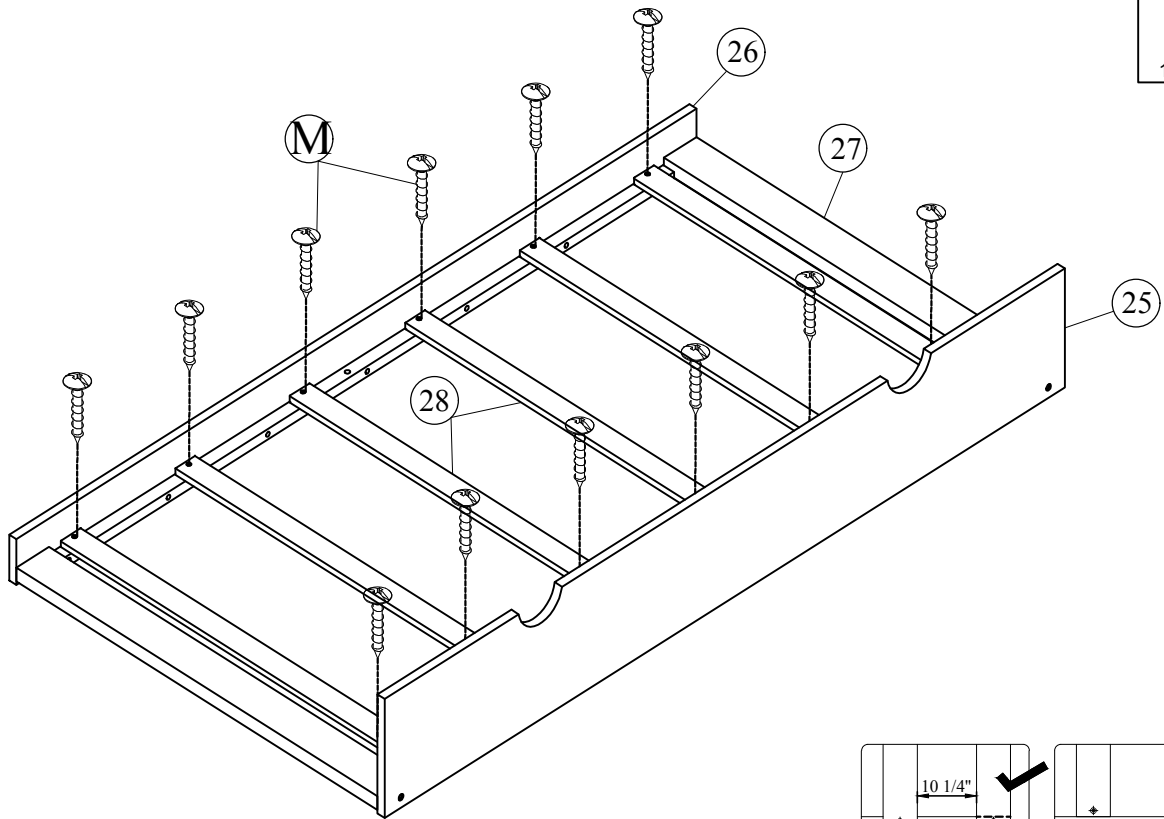
12PCS

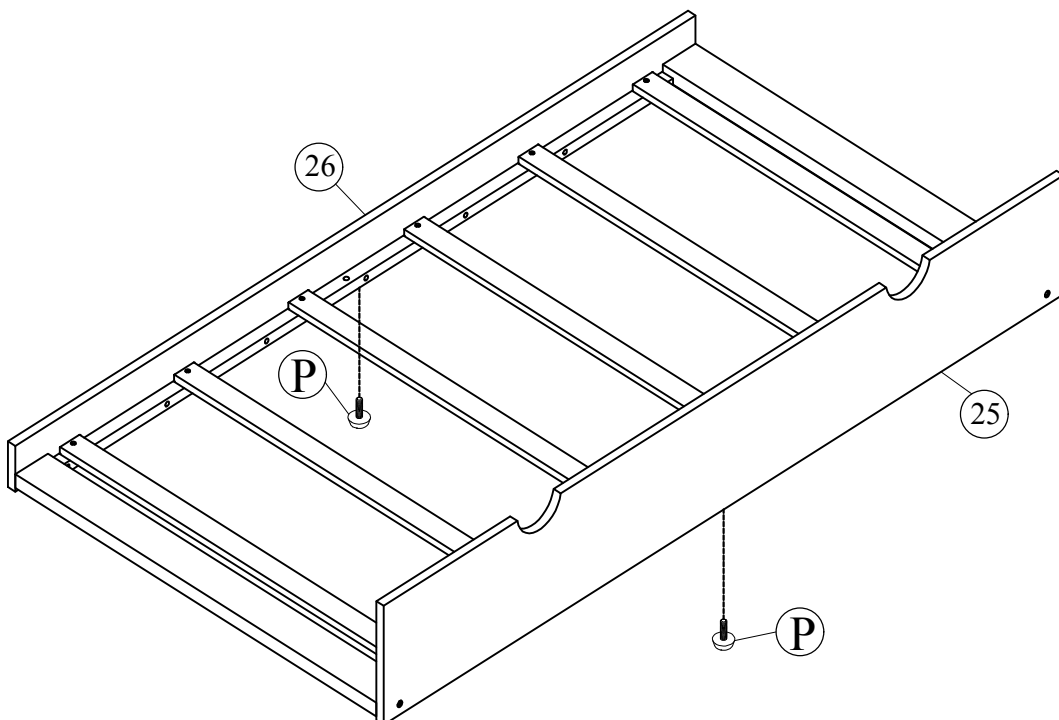

STEP 19:

P

2PCS

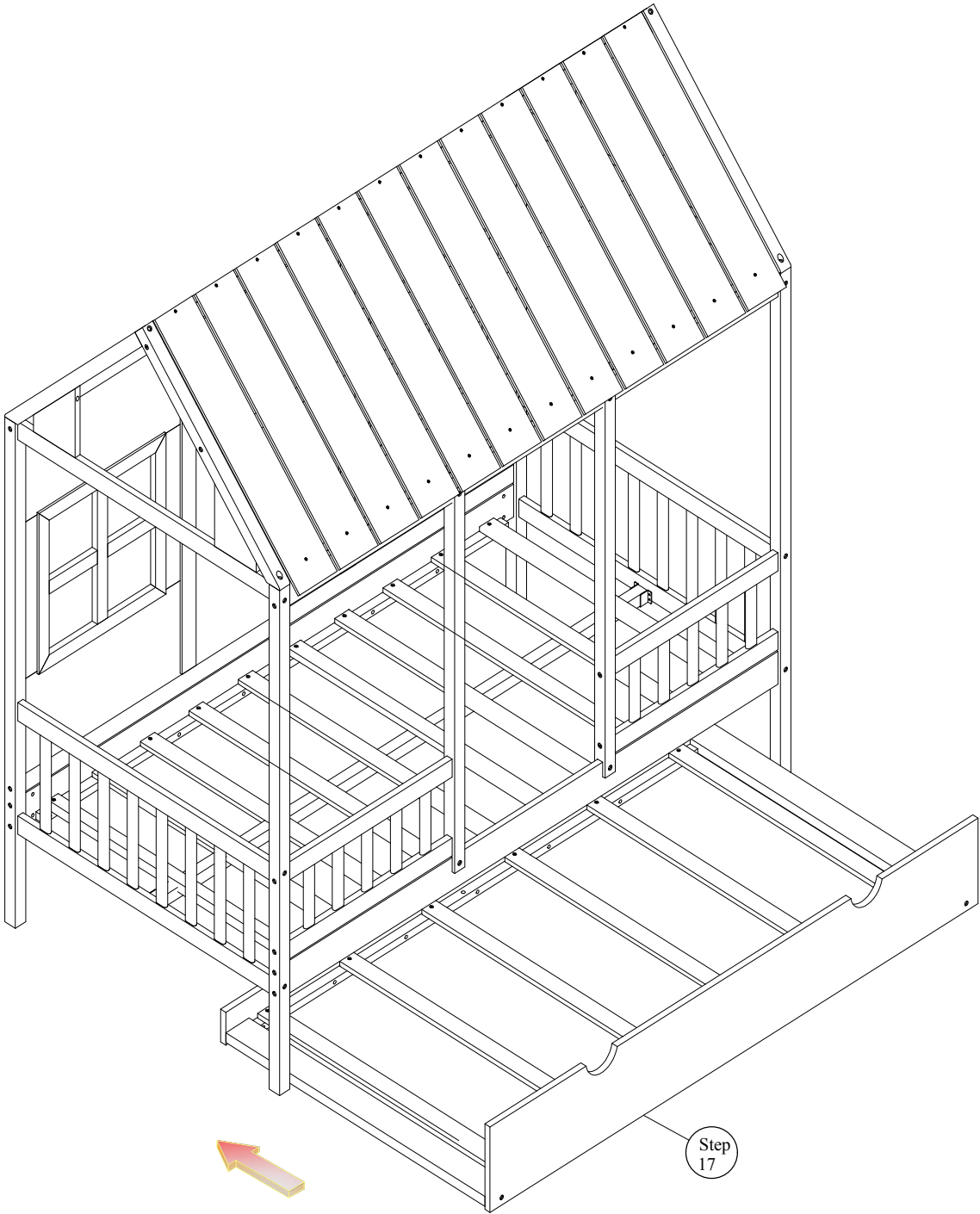

STEP 20:



COMPLETED

