

# HARDWARE

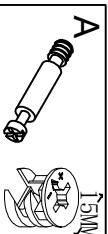

A1



A2  
15MM

36PCS



B1



B2  
12MM

4PCS



28PCS

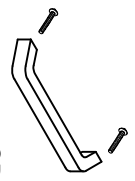

2PCS

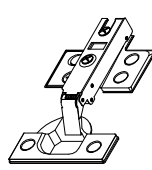

2PCS

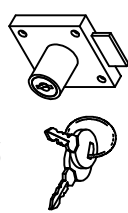

1SET

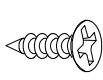

3.5\*14

32PCS



3.5\*35

4PCS



H1



H2

1SET

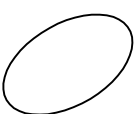

4PCS



12PCS

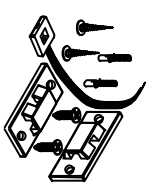

1PCS

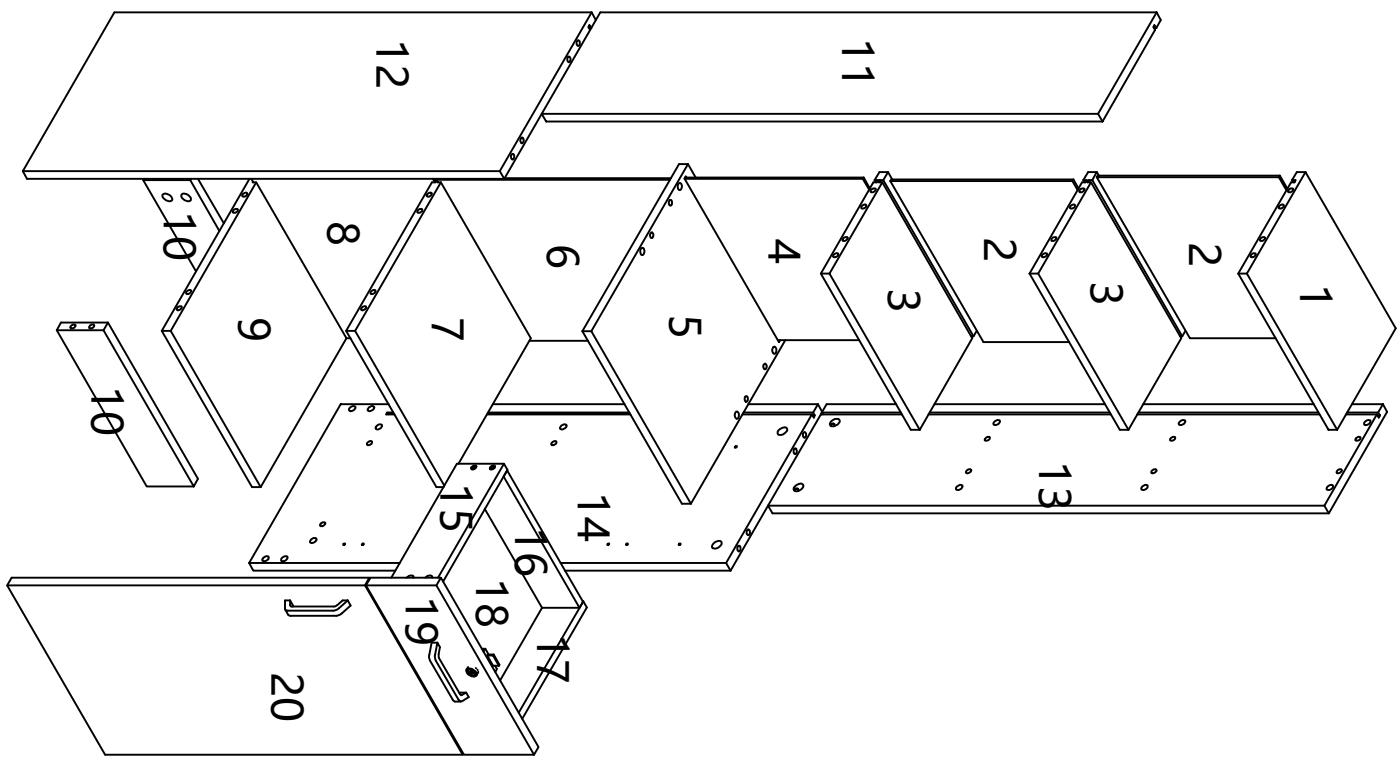
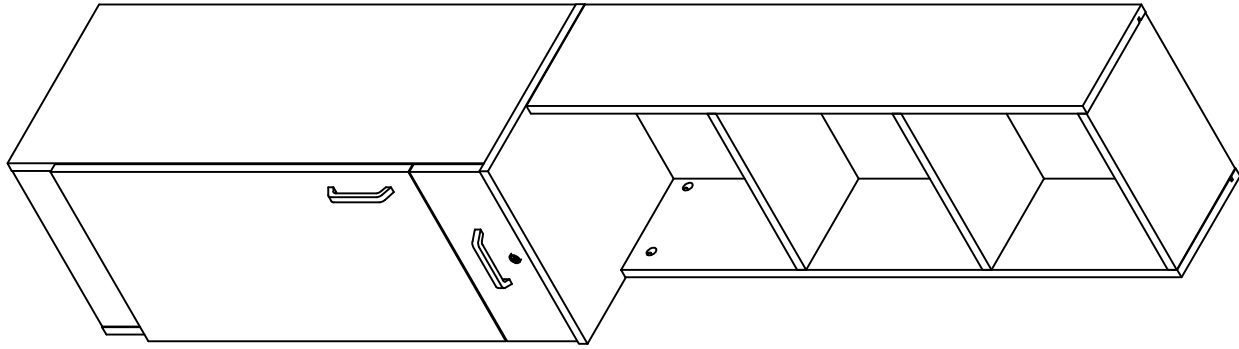

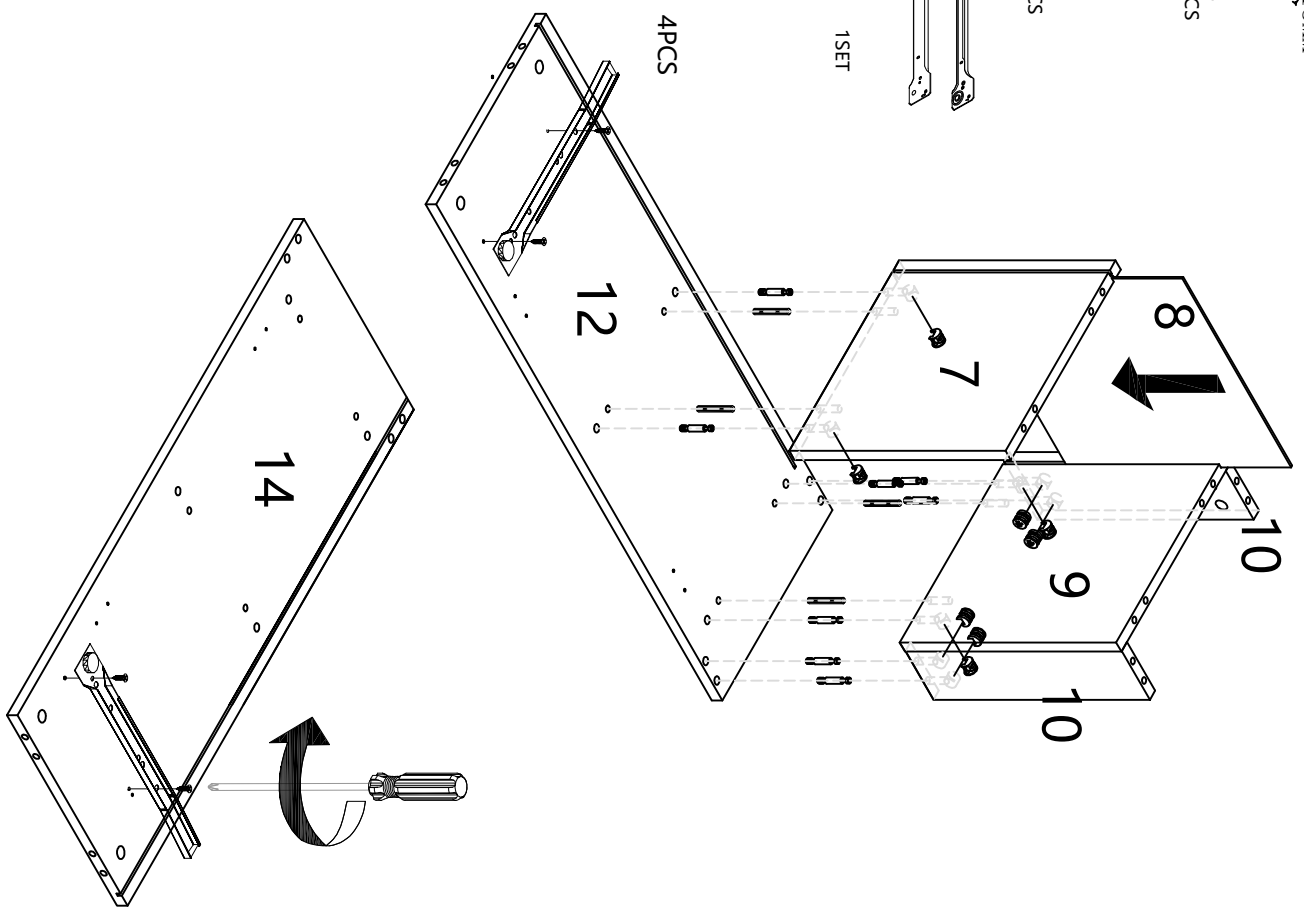
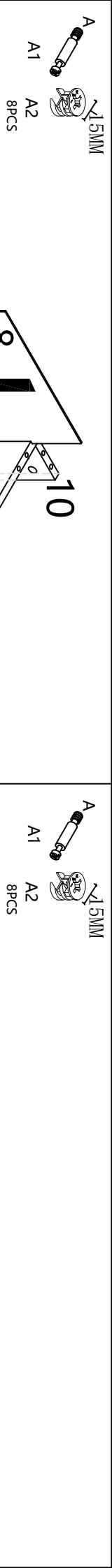

STEP1

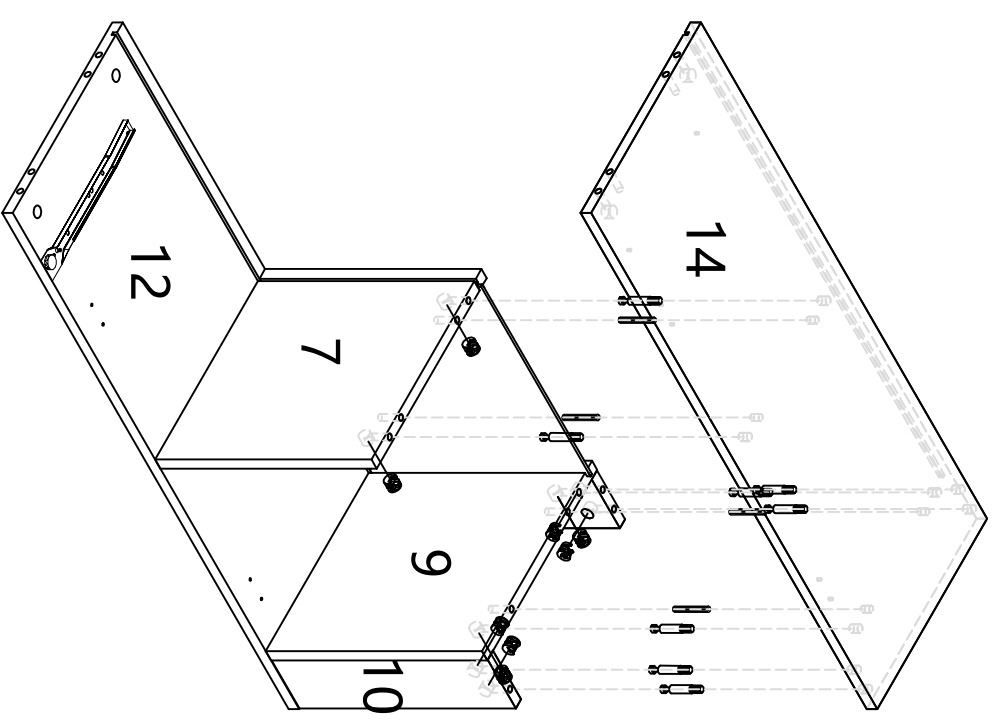
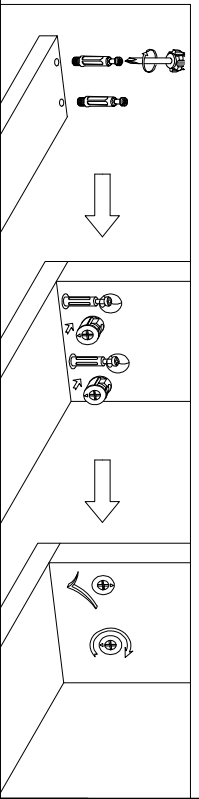

STEP2

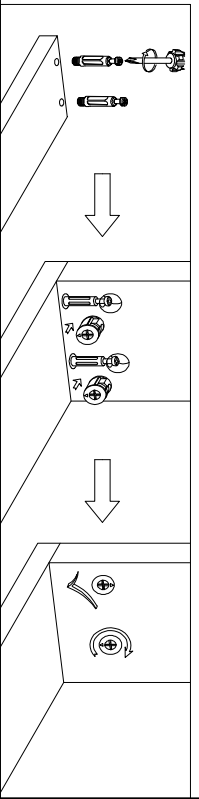

A  
A1  
A2  
4PCS

C  
4PCS

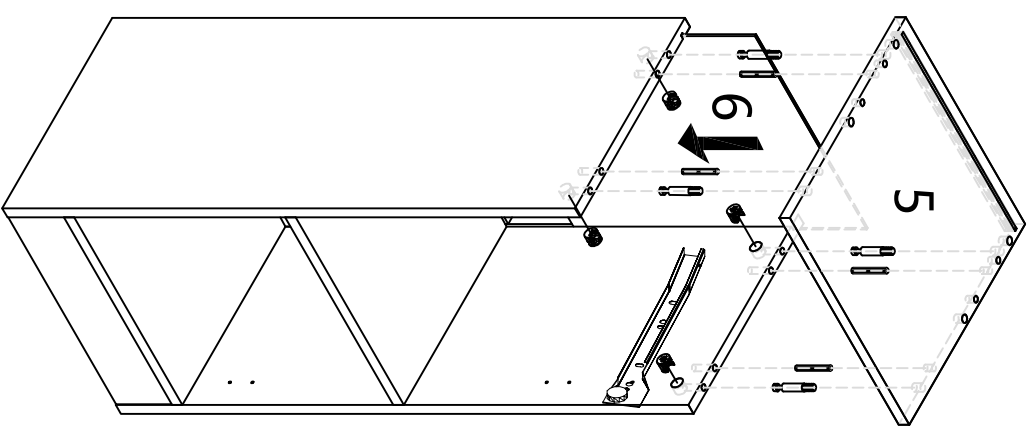

STEP3

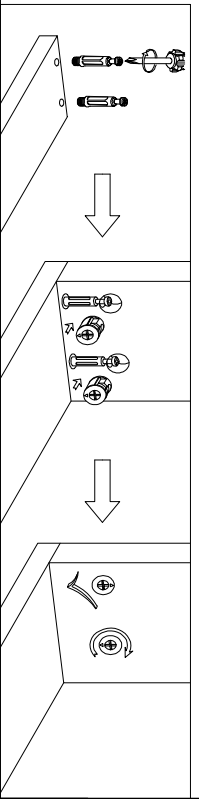

A  
A1  
A2  
12PCS

C  
12PCS

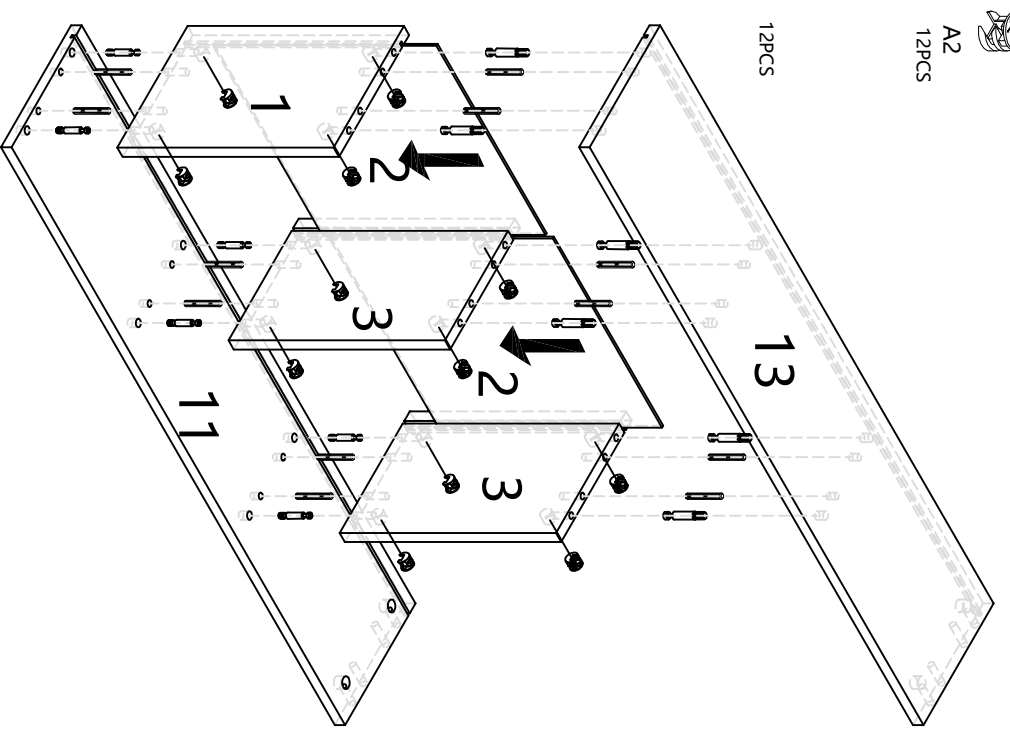

STEP4

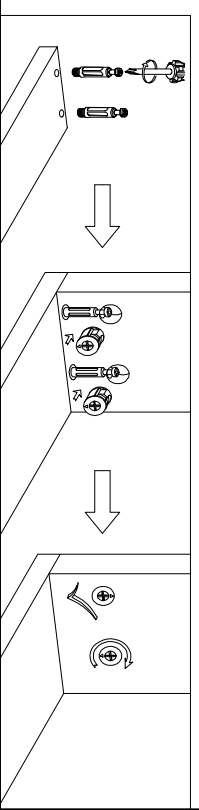

- A 1.5MM
- A1
- A2 4PCS

- C 4PCS

STEP5

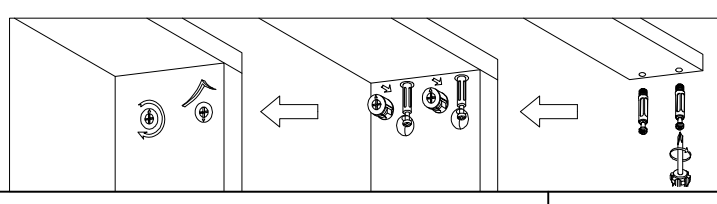
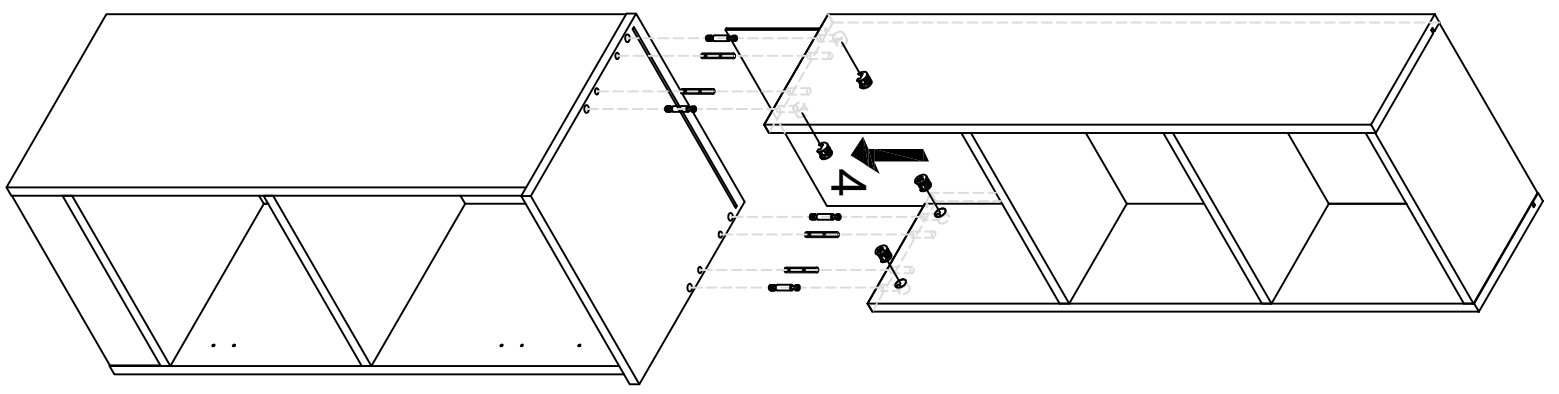

- B B1 1.2MM
- B2 4PCS
- D 2PCS
- E 2PCS
- F 1SET
- H H2 1SET

STEP6

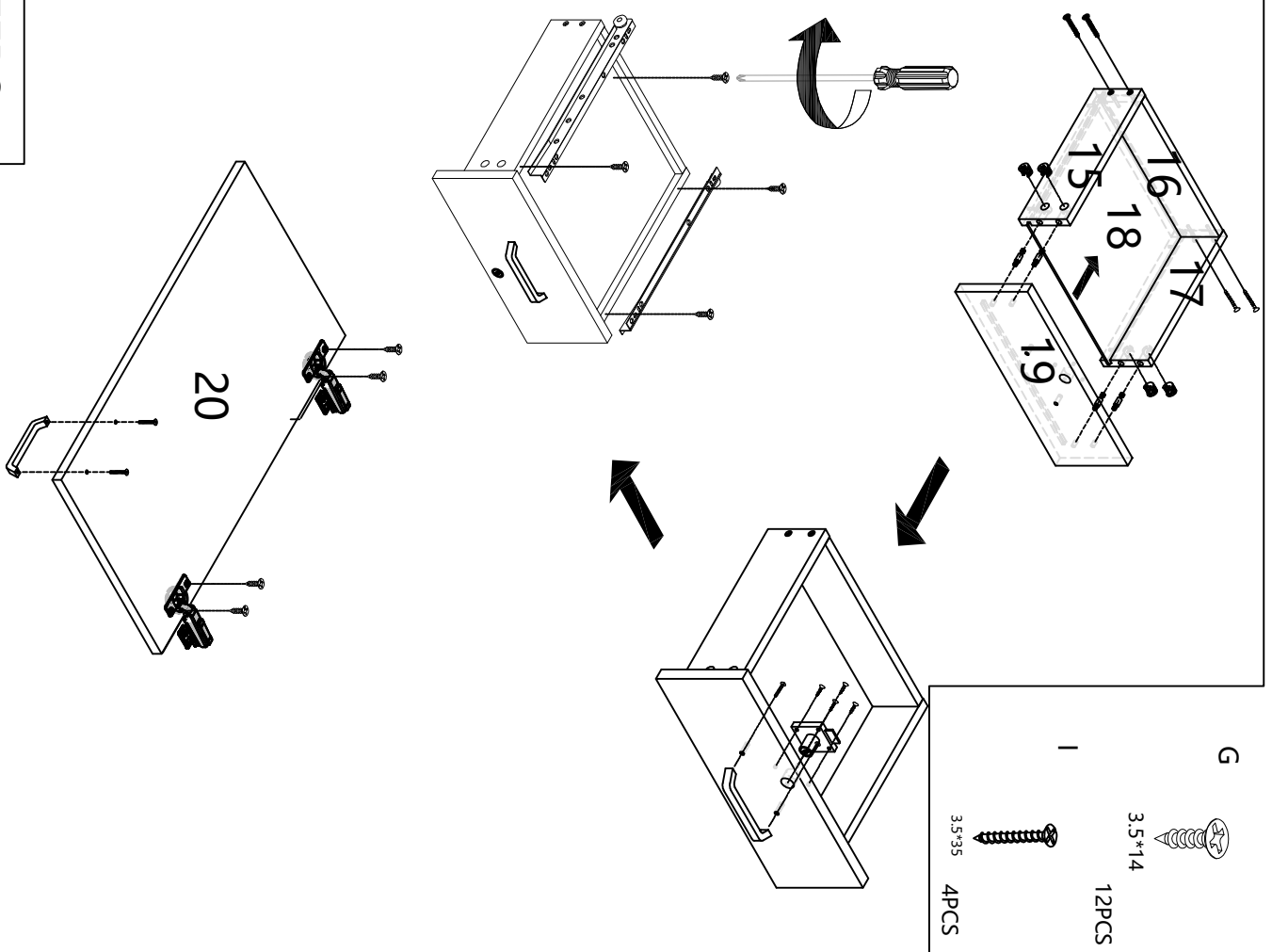

- G 3.5\*14 12PCS
- I 3.5\*35 4PCS

G



3.5\*14

4PCS

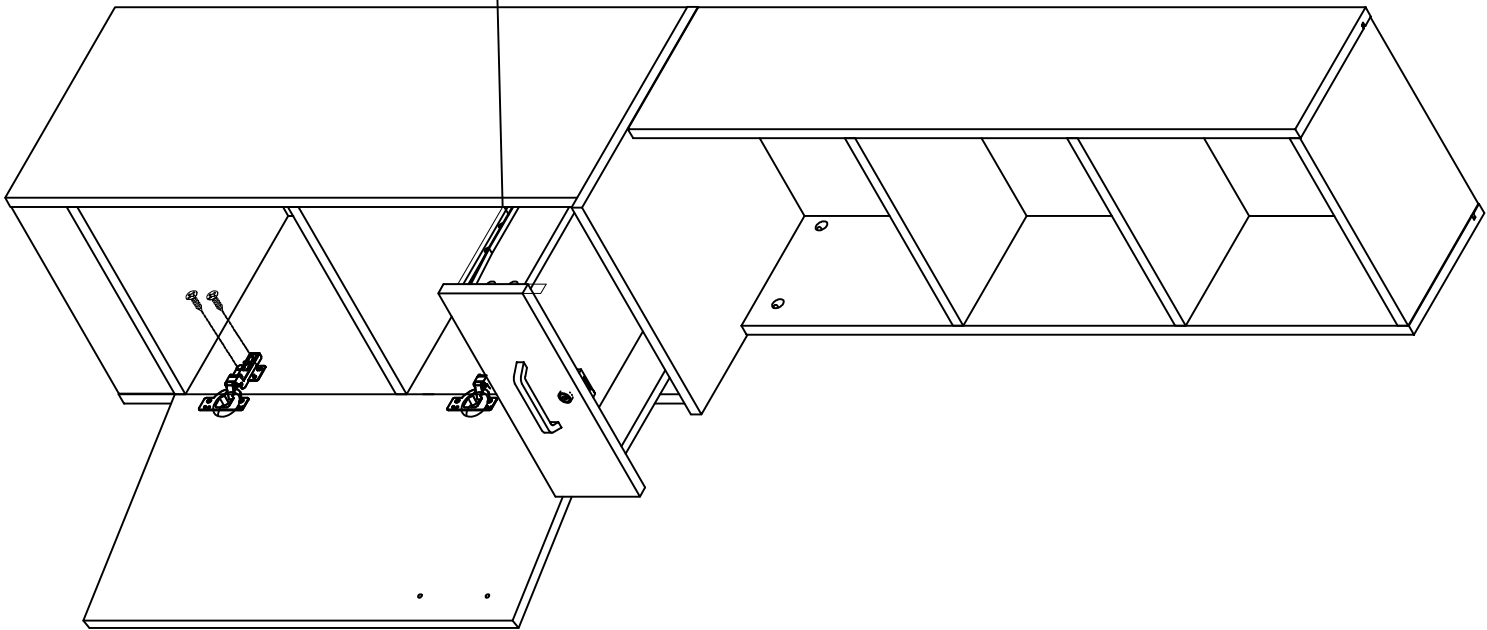
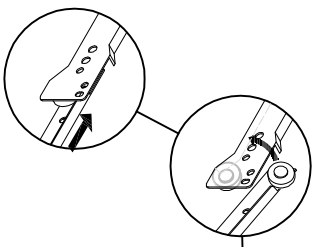

STEP7

J

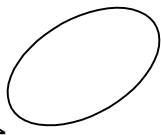

4PCS

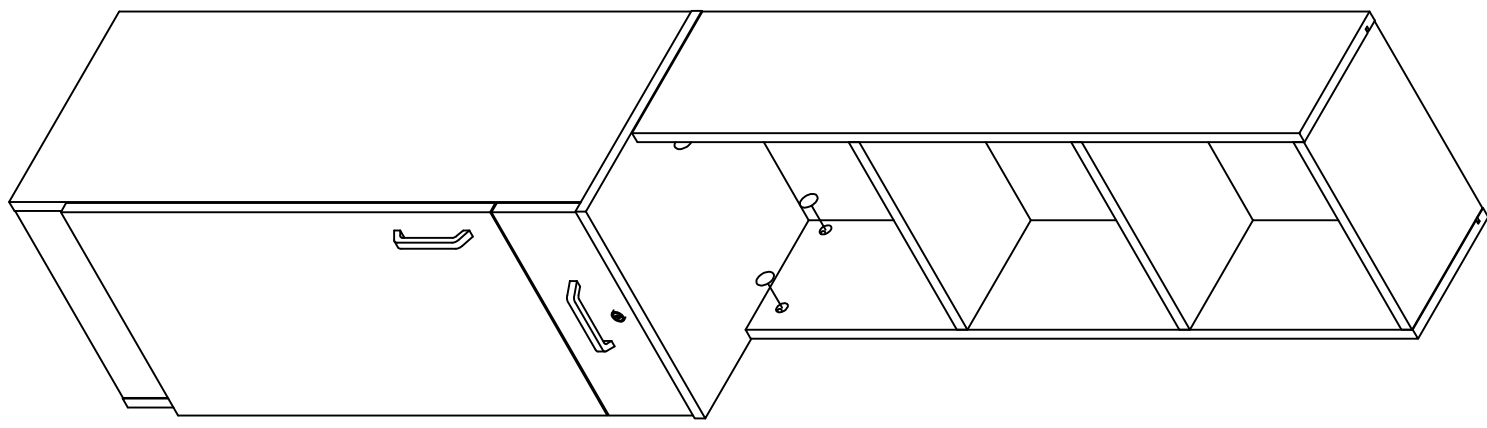

STEP8

G



3.5\*14

12PCS

K



12PCS

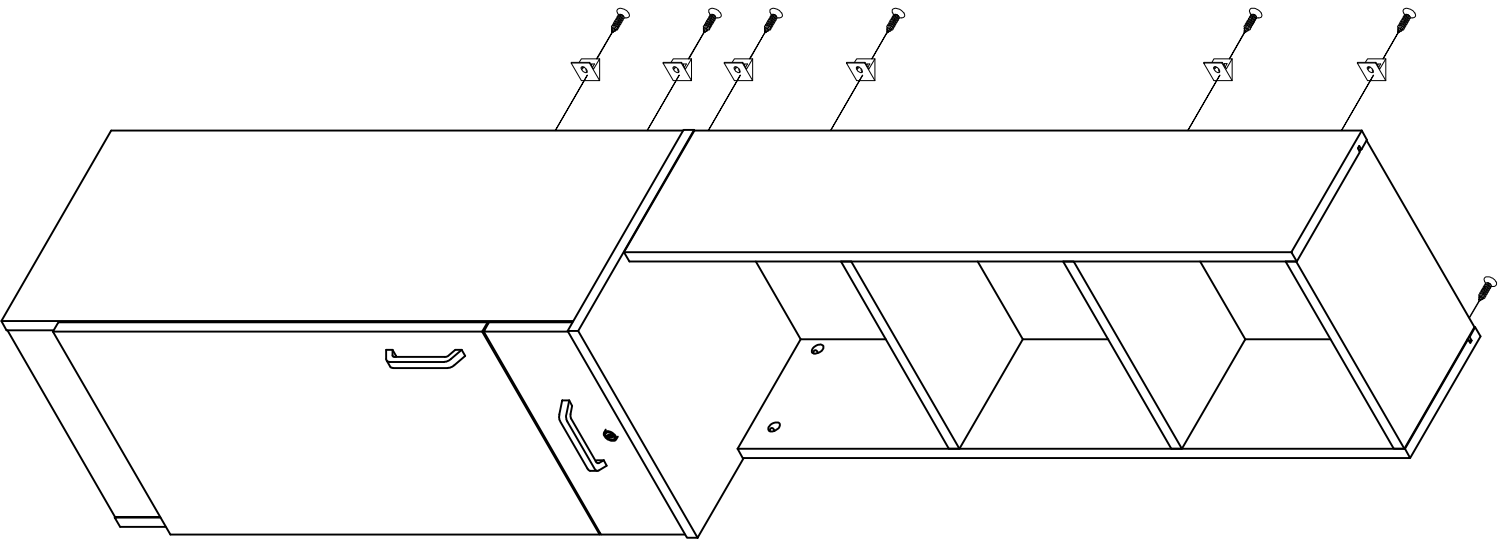

STEP9

K

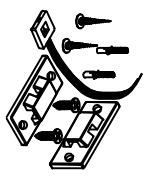

1PCS

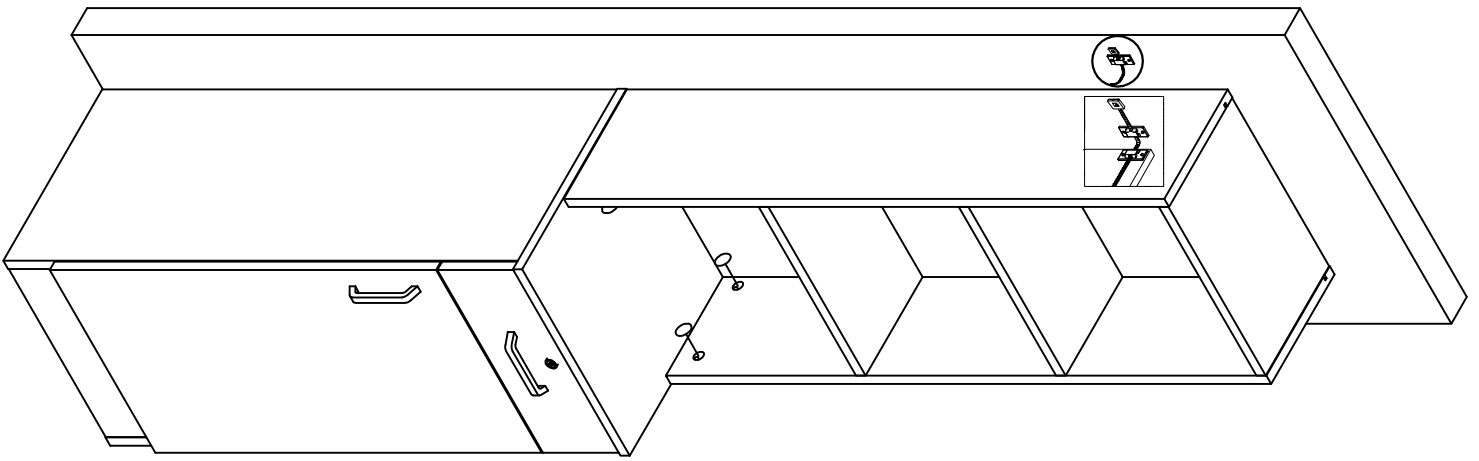
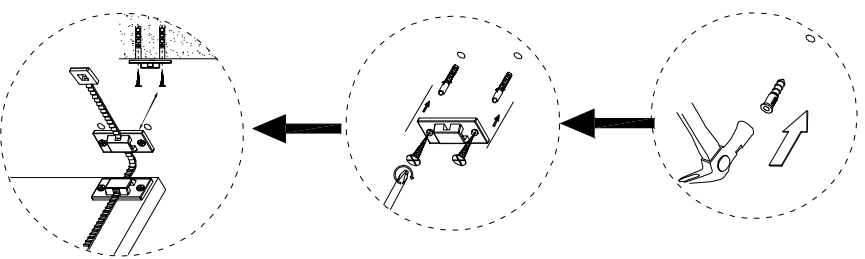

STEP10