

ASSEMBLY INSTRUCTIONS

ROUND TABLE



IMPORTANT NOTE:

- ① PLACE ALL PARTS ON A CLEAN AND SMOOTH SURFACE SUCH AS A RUG OR CARPET TO AVOID THE PARTS FROM BEING SCRATCHED.
- ② BEFORE YOU BEGIN, KINDLY FOLLOW THE ASSEMBLY INSTRUCTIONS STEP BY STEP.
- ③ DO NOT TIGHTEN ALL SCREWS AND BOLTS UNTIL THE TABLE IS FULLY SET-UP

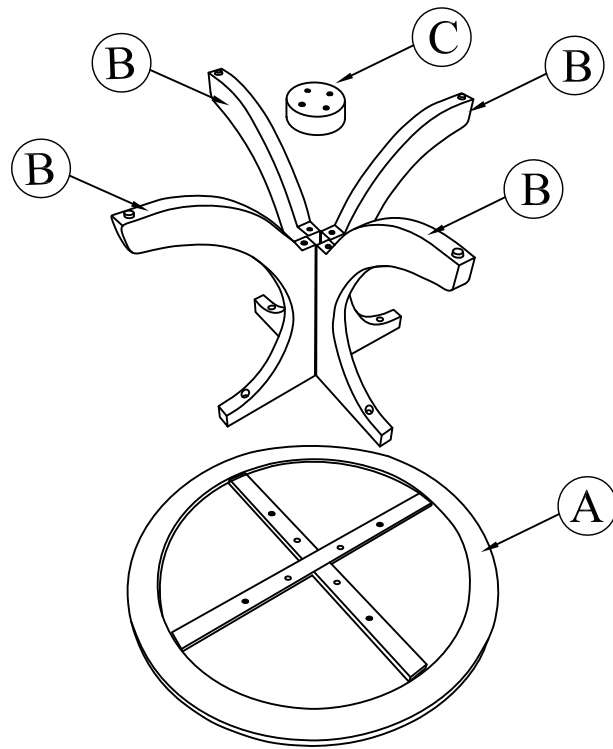

Part List For One

Hardware List For One

A

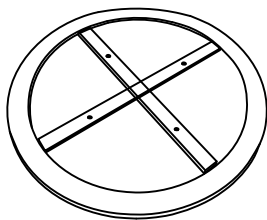
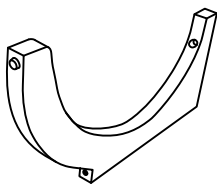

Table Top (1pc)

B



Legs (4pcs)

C

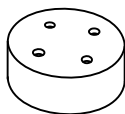

Support Wood (1PC)

1



5/16" x 60mm

BOLT (4PCS)

2



5/16" x 40mm

BOLT (4PCS)

3



5/16" x 13mm

SPRING WASHER (8PCS)

4



5/16" x 19mm

FLAT WASHER (8PCS)

5



4mm

ALLEN KEY (1PC)

6

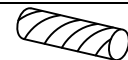

Ø10mm x 40mm

DOWEL (4PCS)

STEP 1

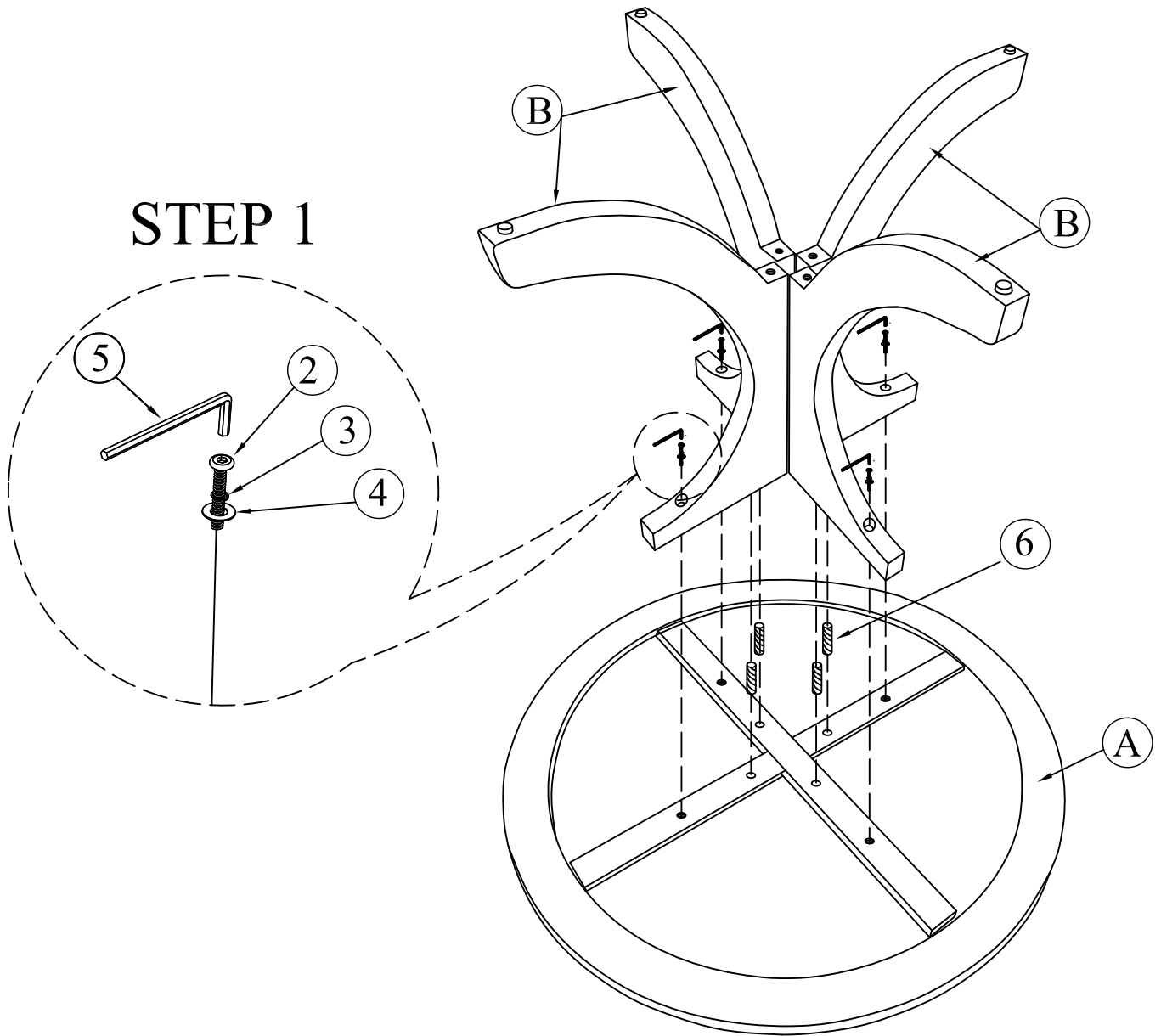

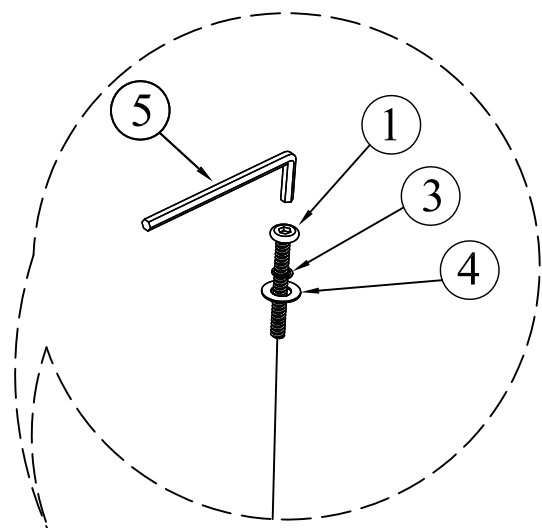

STEP 2

