











Assembly Instructions

Caution : You must read this before you proceed

Care & Maintenance



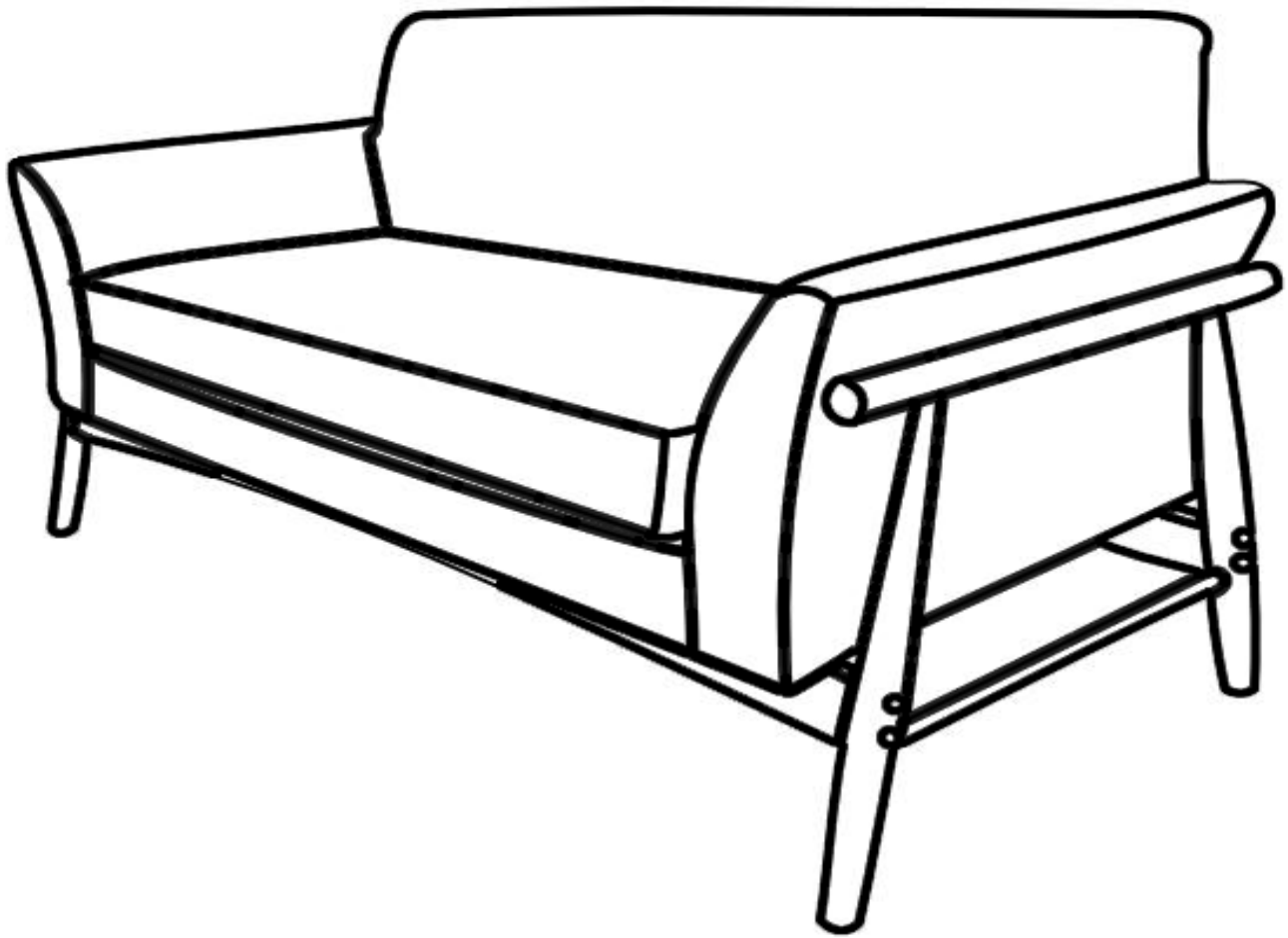

- ⊘  ● Not for commercial use. For residential use only.
- ✓  ● Furniture may scratch floors. We recommend using furniture pads to protect your floors.
- ⊘  ● Do not put hot items directly on furniture surface.
- ⊘  ● Do not clean furniture with harsh cleansers or polish.
- ⊘  ● Do not place furniture under direct sunlight.
- ⊘  ● Do not place furniture near heating or cooling vents.
- ⊘  ● Do not write on furniture without a padded barrier to protect the surface.
- ⊘  ● Do not place furniture outside . For indoor use only.
- ⊘  ● Stains may be removed with mild soap solution and damp cloth.
- ⊘  ● Children should not climb or jump on the furniture.
- ✓  ● Dust and pick-up spills using a clean, non-colored, lint-free cloth.

Please look in ***** for hardware packs and legs.





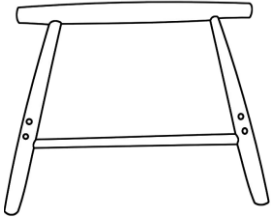

Loveseat



Parts List

Label	Picture	Description	QTY
A		Seat	1
B		Cushion	1
C		Arm	2
D		Base Rail	2

Hardware

Label	Picture	Description	QTY
①		Bolt (M8*60MM)	9
②		Bolt (M6*20MM)	5
③		Spring Washer	5
④		Washer	5
⑤		Allen Wrench(M8)	1
⑥		Allen Wrench(M6)	1
⑦		Wooden Cap	9

Assembly Preparation

Before Beginning Assembly:

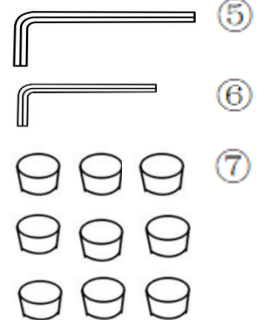
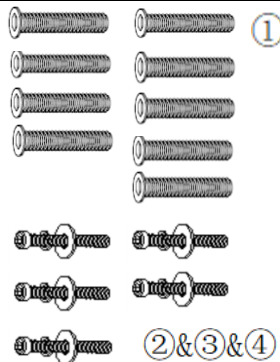
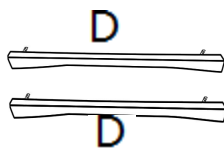
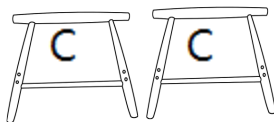
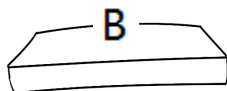
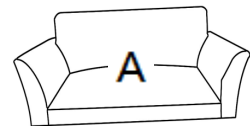

- Read instructions, cover to cover-



- Have 2 adults on hand for assembly-



- Do not assemble on flooring or carpet-



- Assemble on a clean non-marring surface (packing foam)-



- Save all packaging until finished-

Assembly Steps

Overview

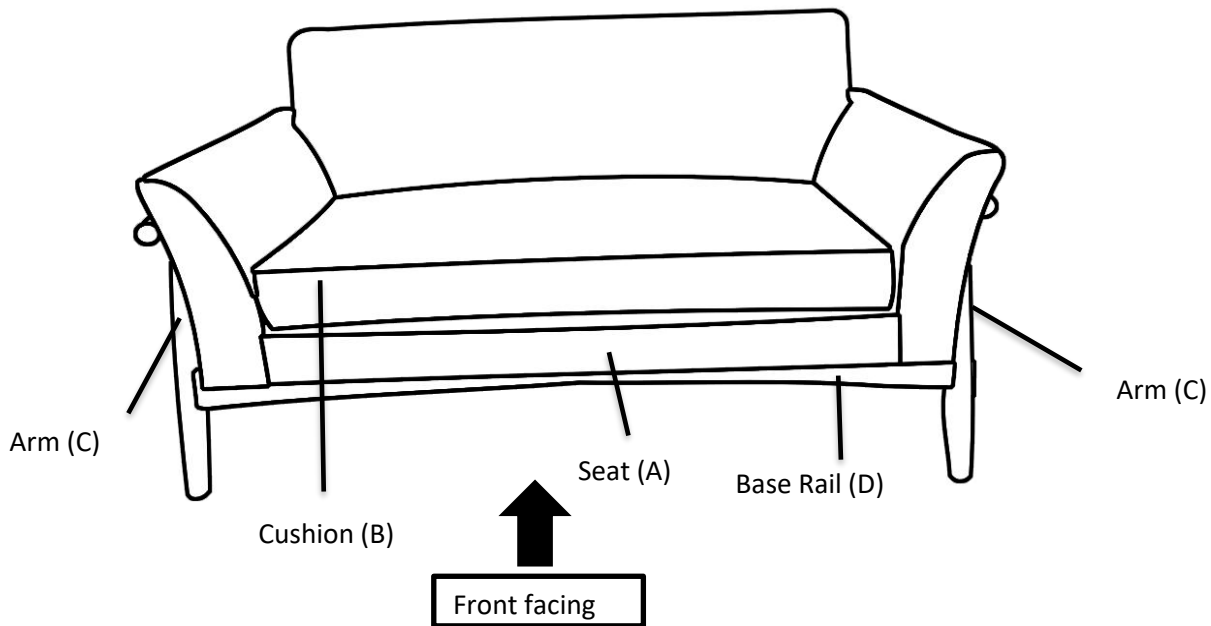

This Loveseat has multiple parts and may require up to 30 minutes to assemble. To give you an overview of the Loveseat parts, the above picture is to help you put the various parts into perspective. Please read through the instructions below to familiarise yourself with the parts and steps before assembly.

Step 1

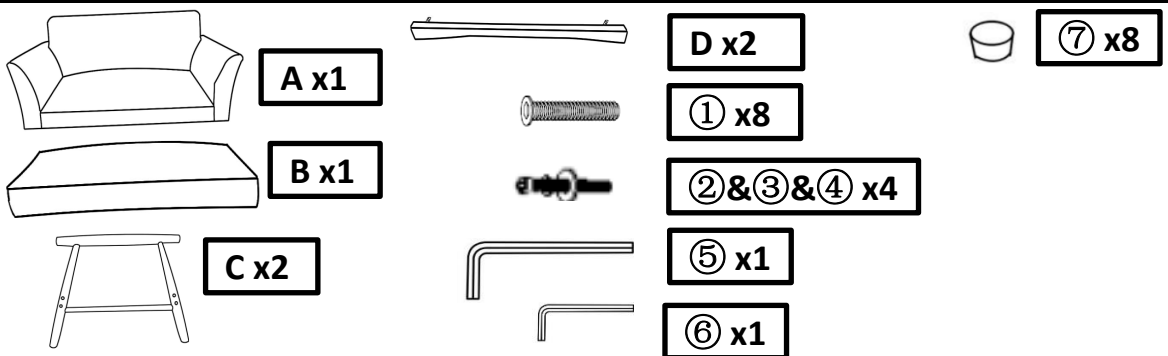

Unpack and place all the Parts and Hardware on a clean, non-marring surface.

Step 2

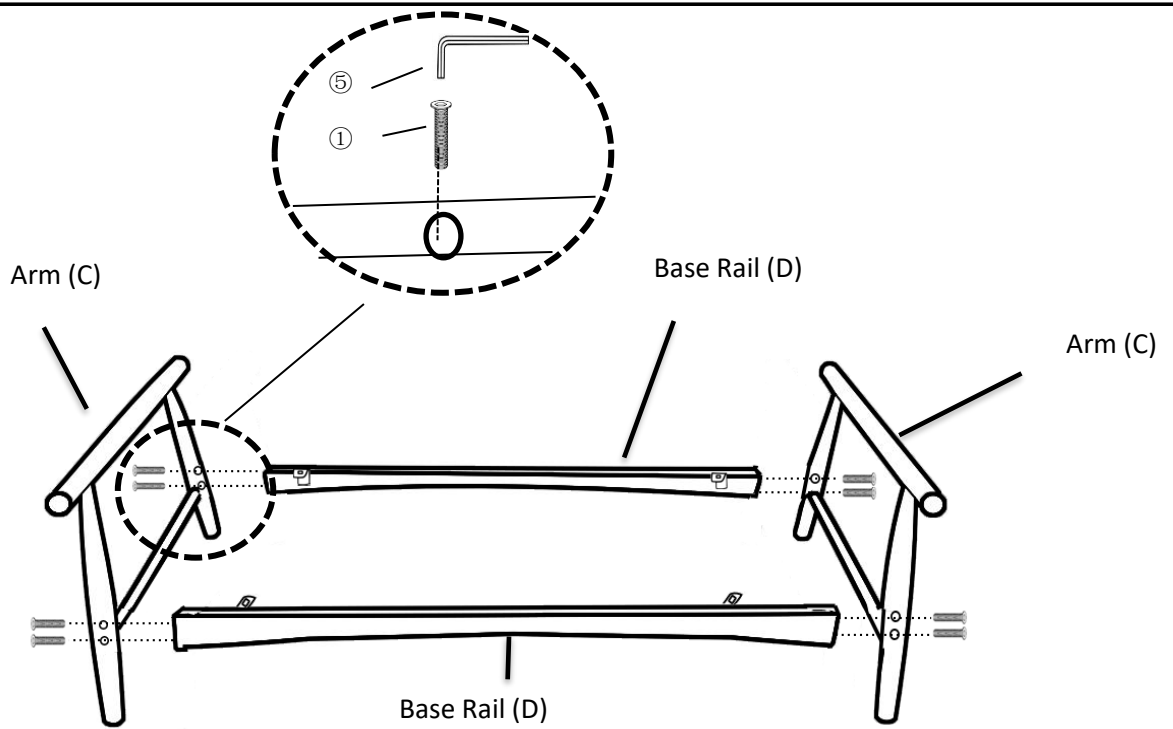

Put the Arm(C) and Base Rail(D) onto a clean, non-marring surface. Align the mounting positions of the Arm(C) with Rail(D) and attach them using Bolts(①) with Allen Key(⑤).

Step 3

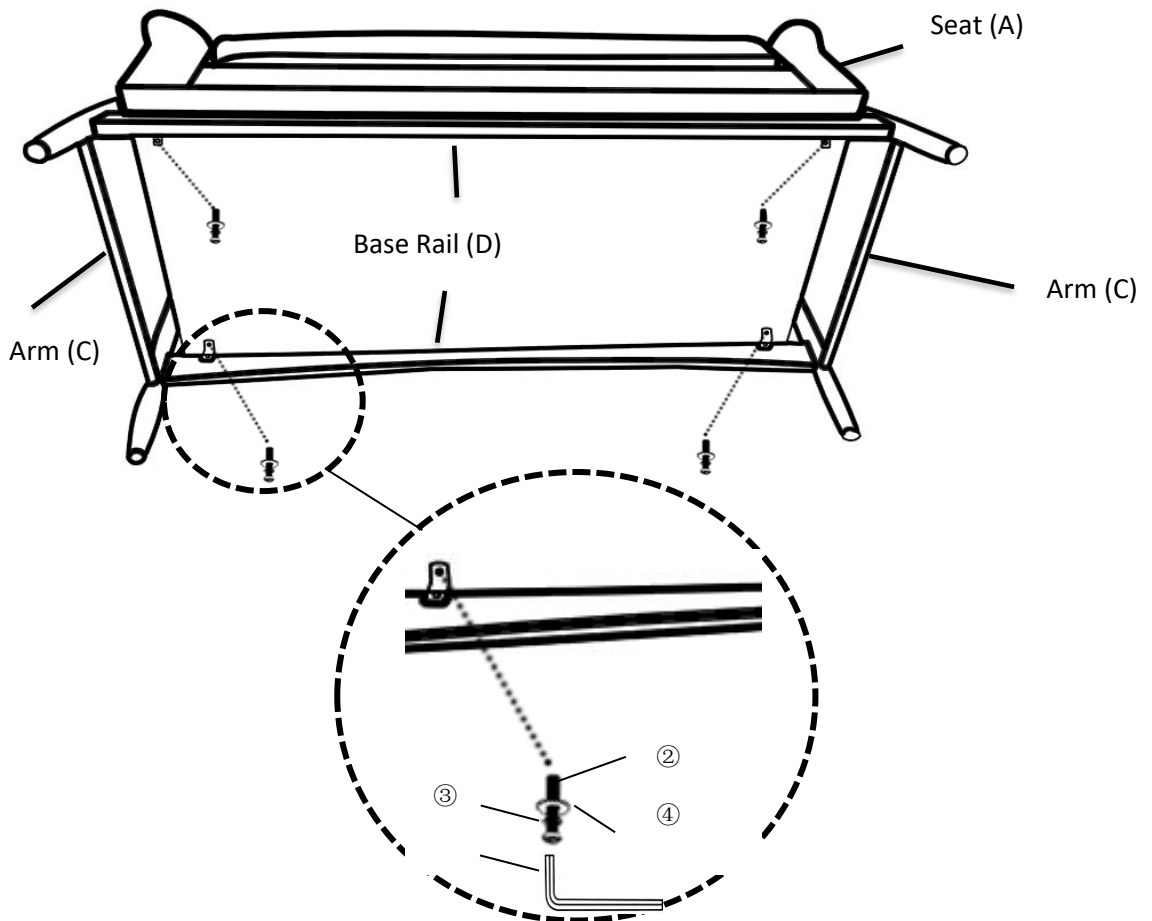

Place the Seat(A) onto the assembled frame (C+D) as seen in the above picture and install the Bolt(②), Spring Washers(③) and Washers(④) with Allen Key(⑥).

Step 4

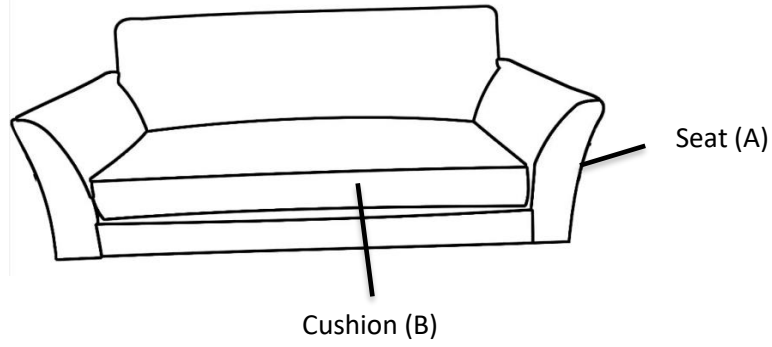

Put the Cushion(B) onto the Seat(A).

Step 5

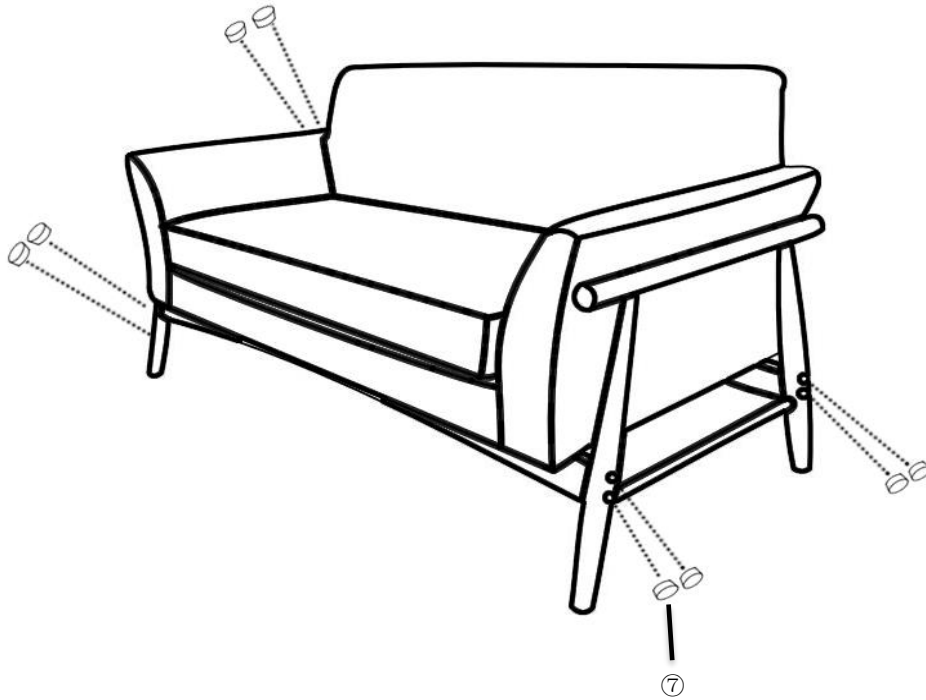

Cover the bolt hole with the Wooden Cap(⑦) and put the Cushion(B) onto the Seat(A), shown as picture.

Step 6

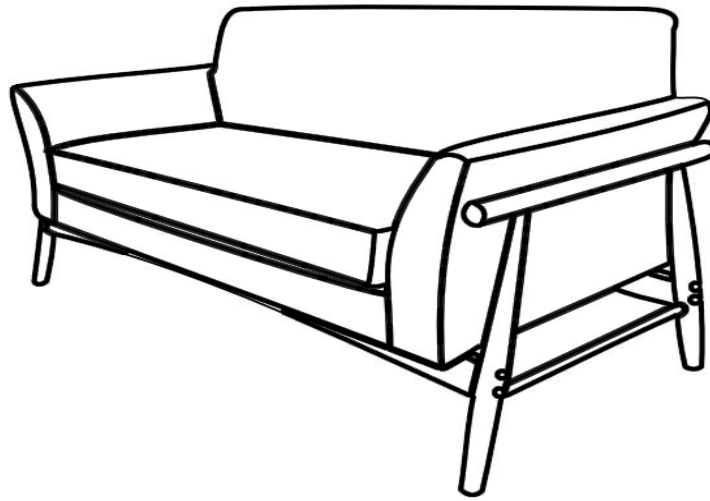

Finally, make sure all parts are connected and securely locked into position.
Your Loveseat is ready for use.

Caution: This Loveseat can only be used on a flat, level surface.