

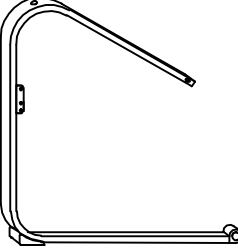









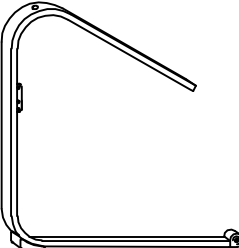

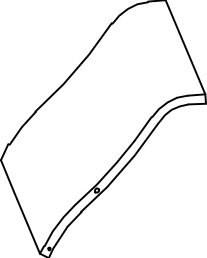

A	 <p>X 1</p>	H	 <p>X 1</p>
B	 <p>X 1</p>	I	<p>M6*12</p>  <p>X 6</p>
C	 <p>X 1</p>	J	<p>M6*20</p>  <p>X 2</p>
D	 <p>X 1</p>	K	<p>M6*25</p>  <p>X 2</p>
E	 <p>X 1</p>	L	<p>M6*35</p>  <p>X 4</p>
F	 <p>X 1</p>	M	<p>M6</p>  <p>X 14</p>
G	 <p>X 1</p>	N	<p>M6</p>  <p>X 1</p>

1

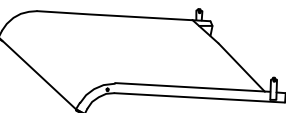

2

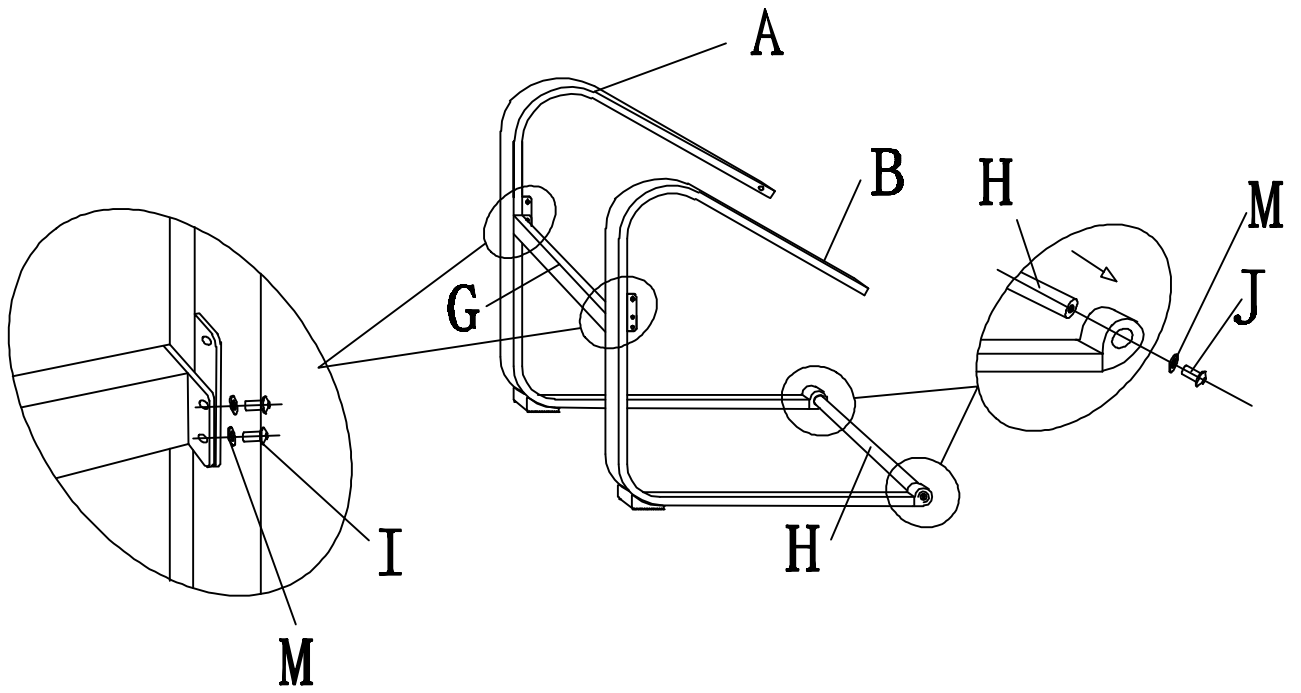
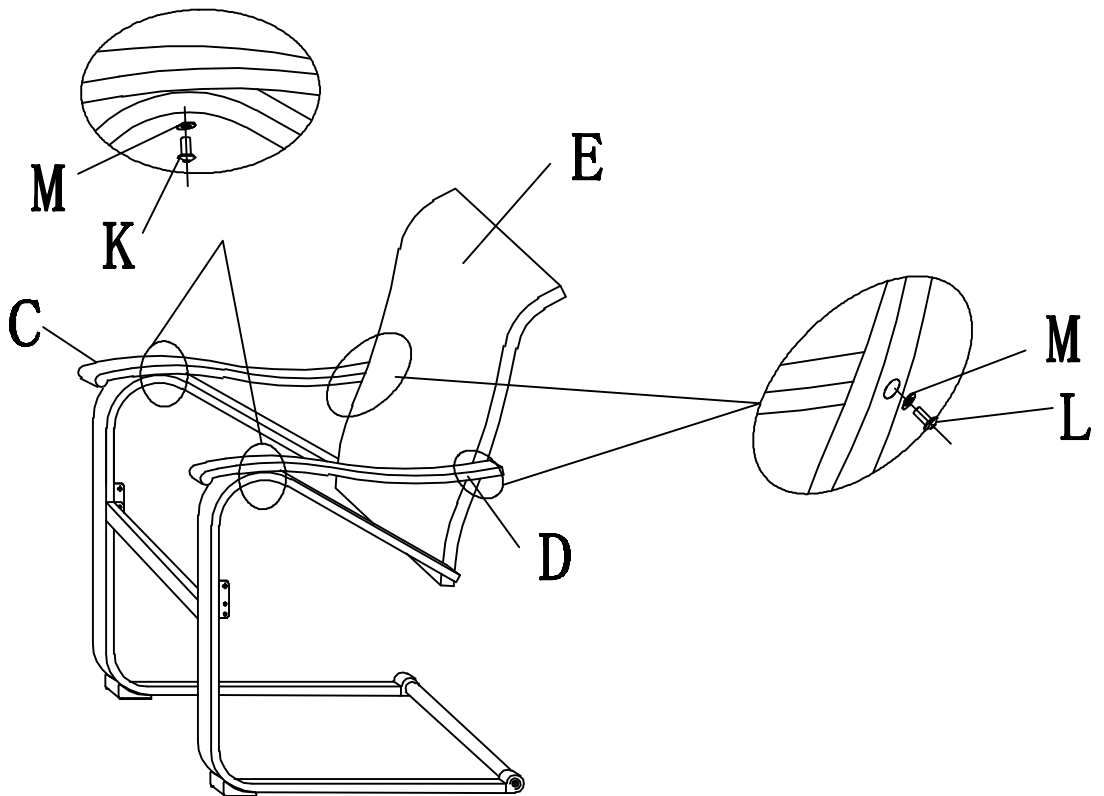

3

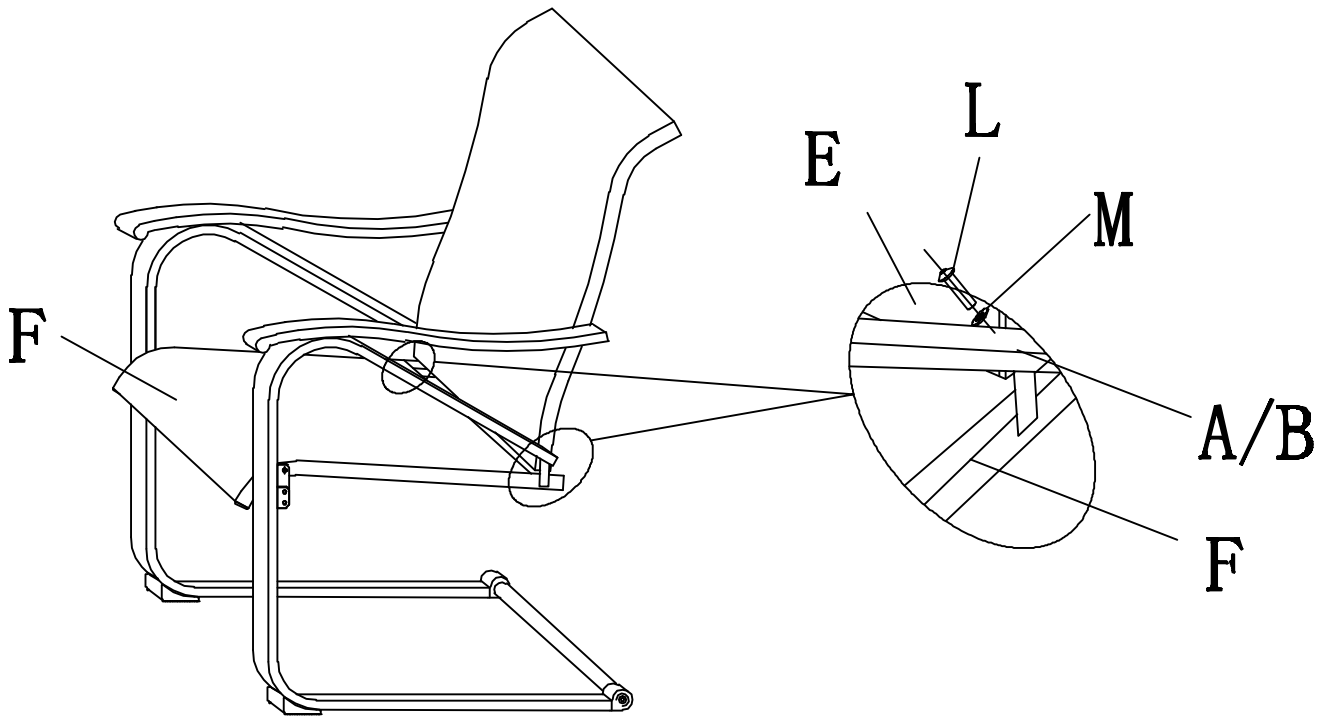

4

