

SIDE BOARD

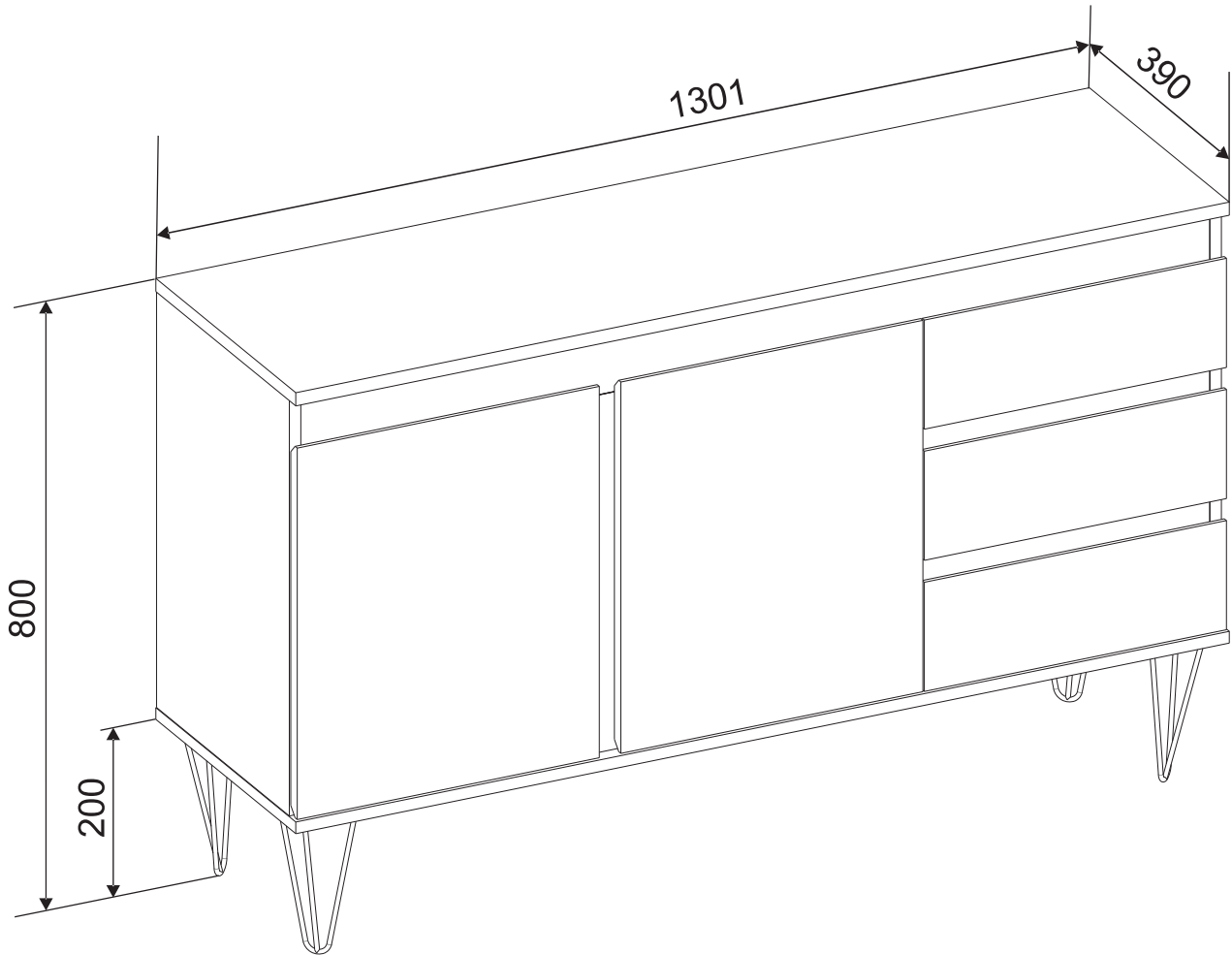

180 min.

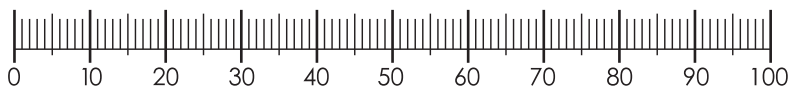
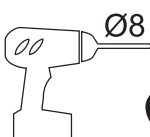
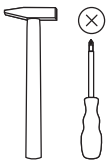
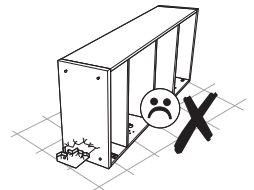
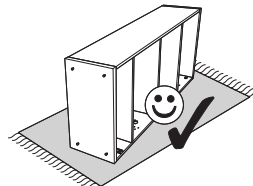
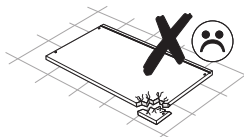
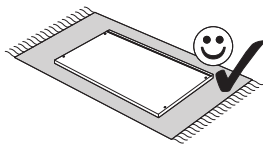

SIDEBOARD

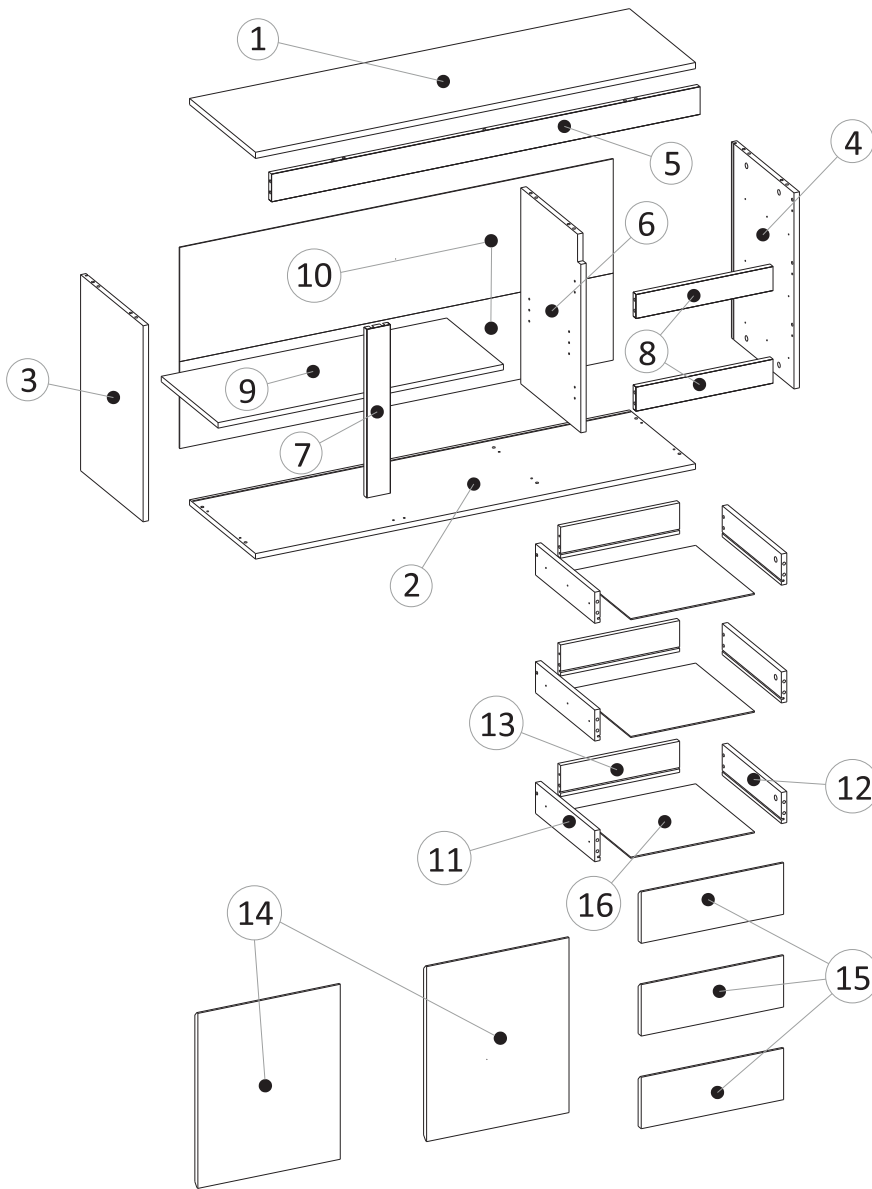

| I. | L. | W. | QTY. |
|----|------|-----|------|
| 1 | 1301 | 390 | 1 |
| 2 | 1301 | 390 | 1 |
| 3 | 568 | 370 | 1 |
| 4 | 568 | 370 | 1 |
| 5 | 1267 | 80 | 1 |
| 6 | 568 | 355 | 1 |
| 7 | 488 | 70 | 1 |
| 8 | 405 | 70 | 2 |
| 9 | 844 | 335 | 1 |
| 10 | 1282 | 583 | 1 |
| 11 | 350 | 90 | 3 |
| 12 | 350 | 90 | 3 |
| 13 | 352 | 90 | 3 |
| 14 | 507 | 421 | 2 |
| 15 | 421 | 149 | 3 |
| 16 | 366 | 348 | 3 |

BAG 1

| | | | | |
|--------|---------|-------|--------|--------|
| PP x4 | K x32 | T x27 | M x27 | KN x6 |
| | | | | |
| Z x33 | RT x4 | RP x4 | SP x10 | W2 x10 |
| | | | | |
| W1 x60 | P x3 | | Q x1 | |
| | | | | |
| 4x16 | (PB+PS) | | | |

BAG 2

| |
|--------|
| ZR x4 |
| |
| ZP x4 |
| |
| WE x8 |
| |
| 6,3x13 |

BAG 3

| |
|------|
| N x4 |
| |

BAG 4

| | |
|-------|-------|
| W1 x2 | LK x1 |
| | |
| 4x16 | |
| W3 x1 | KR x1 |
| | |
| 4x70 | |

1

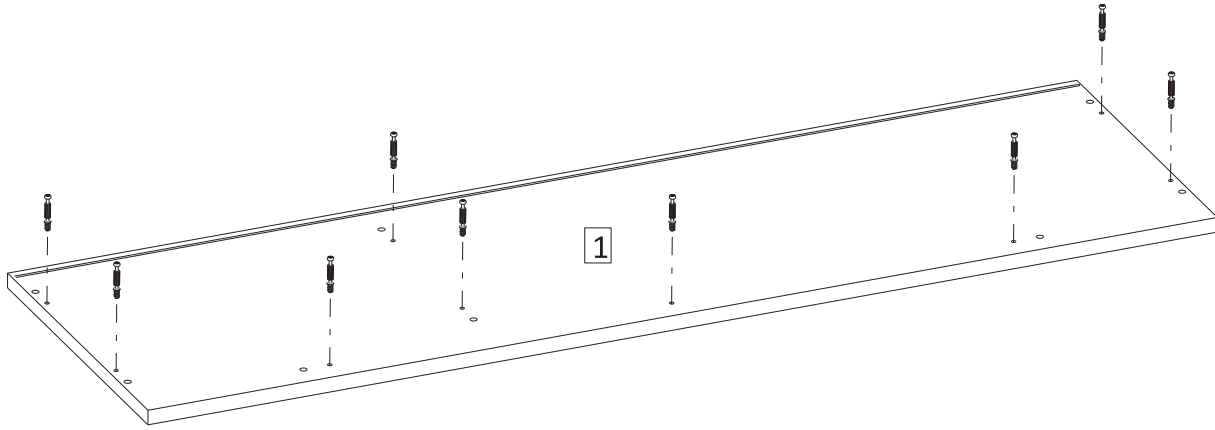
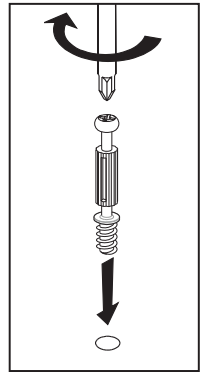
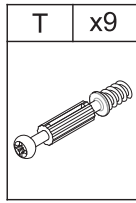
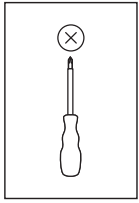

2

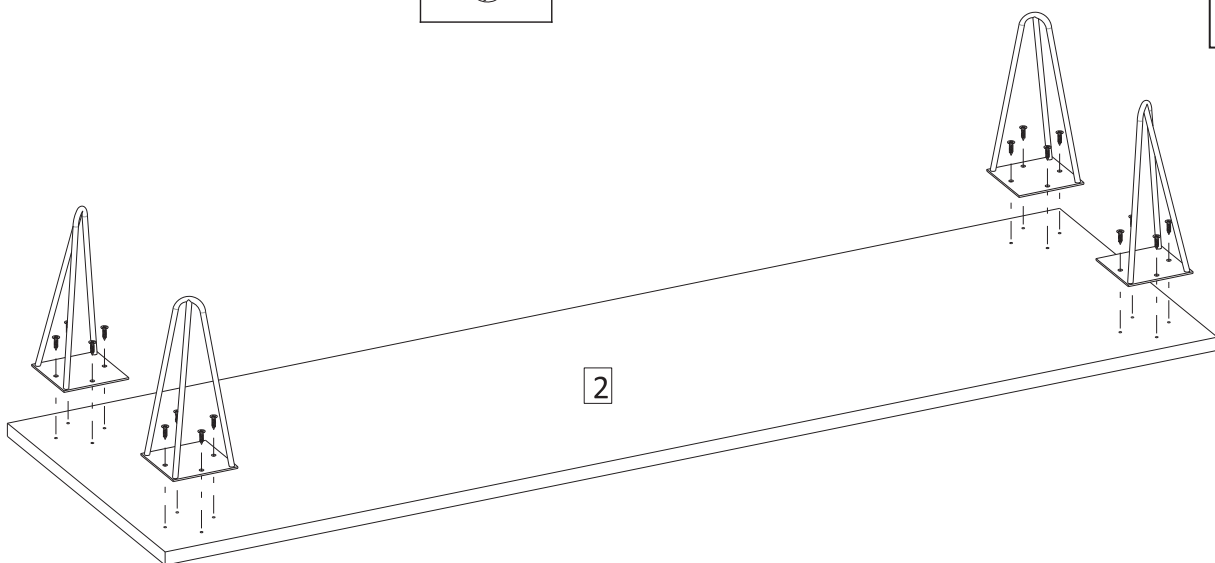
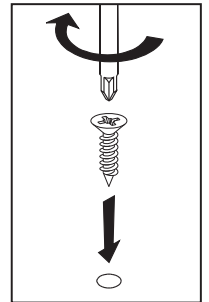
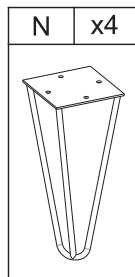
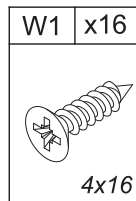
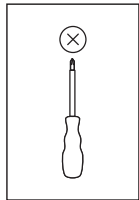

3

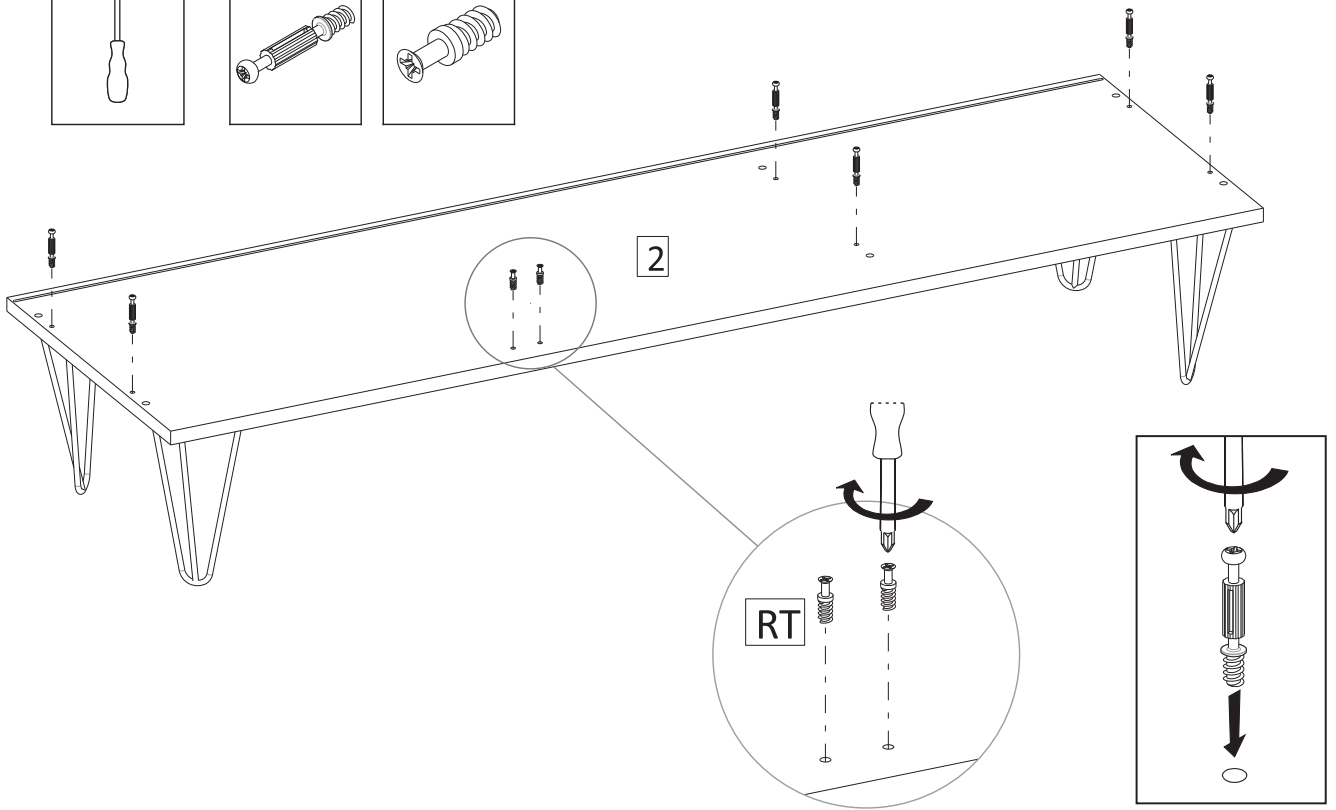
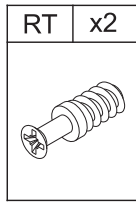
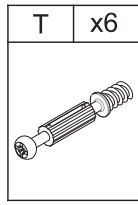
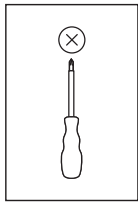

4

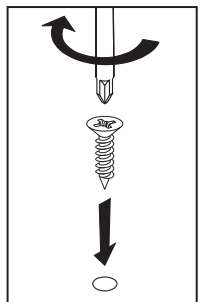
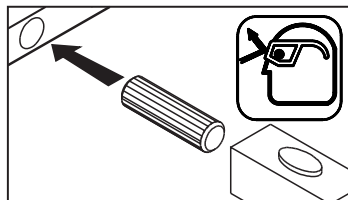
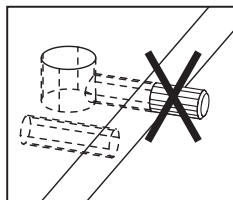
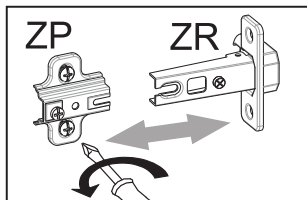
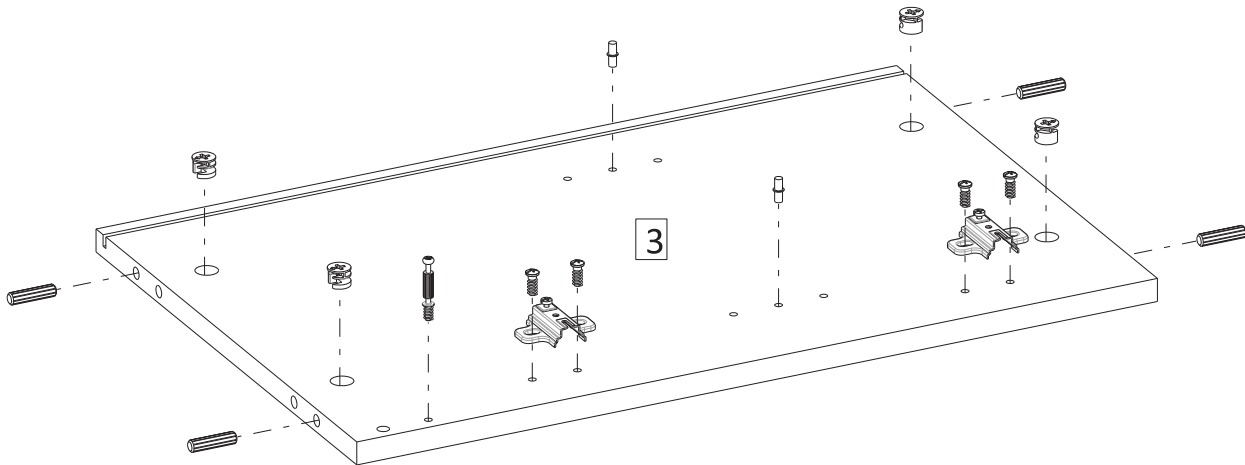
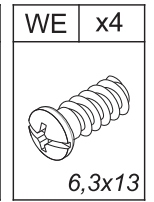
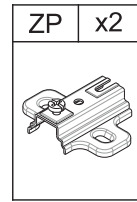
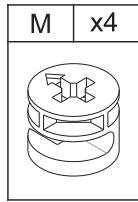
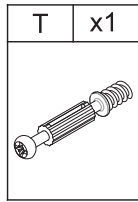
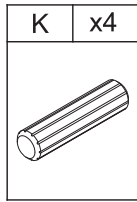
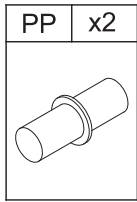
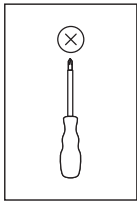
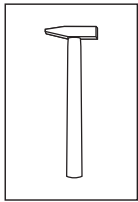

5

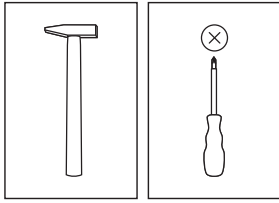

| | |
|-------------|----|
| P | x3 |
| (PB+PS) | |

| | |
|----------|----|
| W1 | x9 |
| 4x16 | |

| | |
|---|----|
| K | x4 |
| | |

| | |
|---|----|
| T | x3 |
| | |

| | |
|---|----|
| M | x4 |
| | |

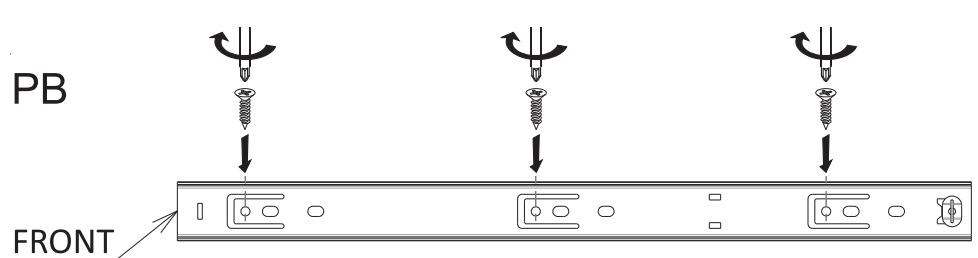
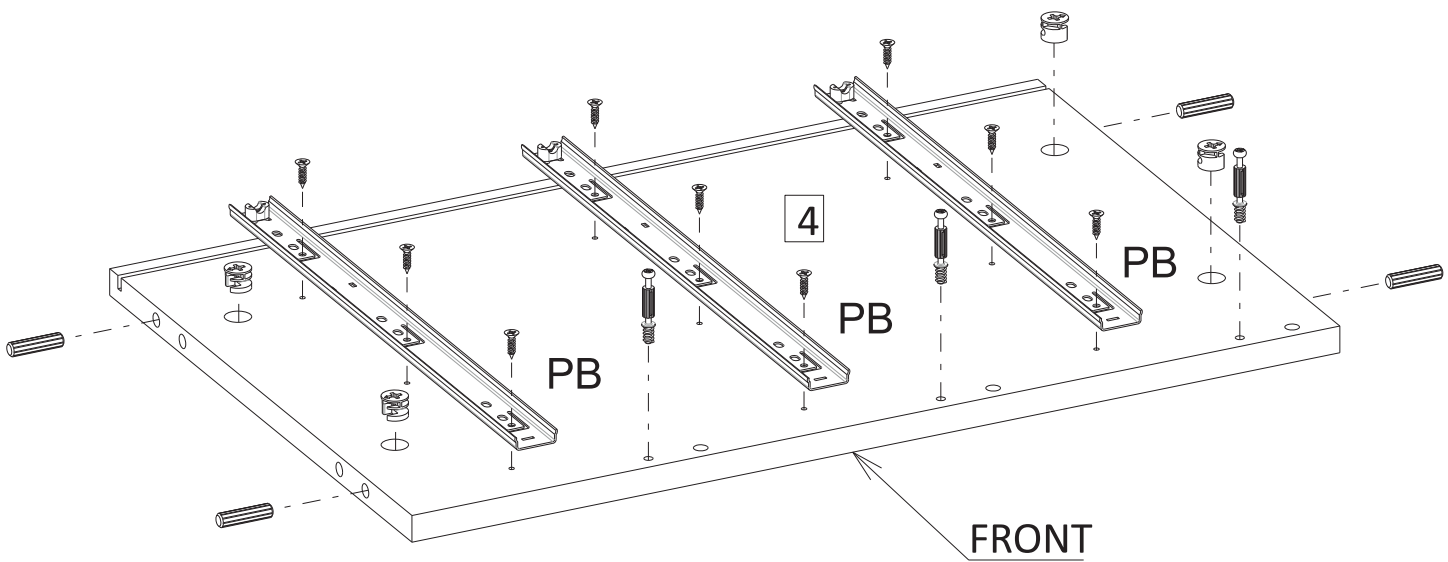
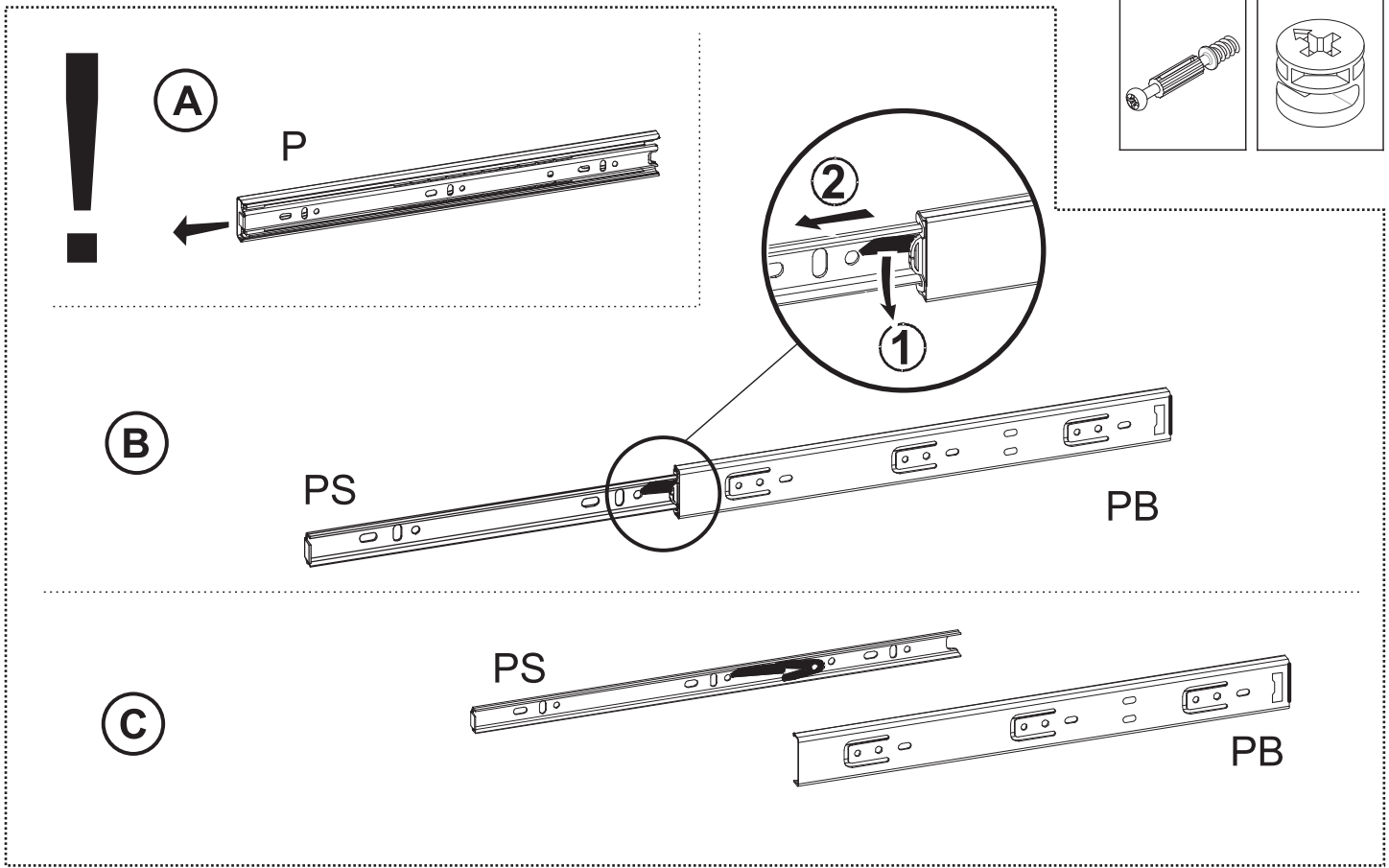

6

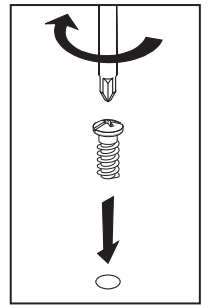
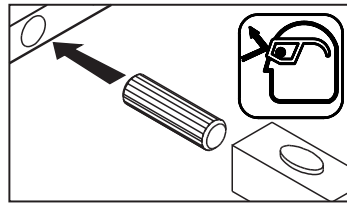
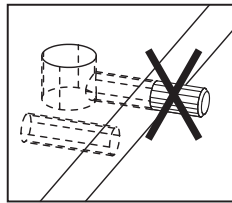
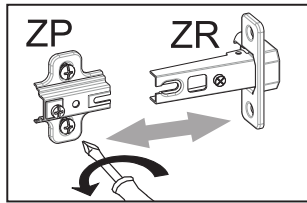
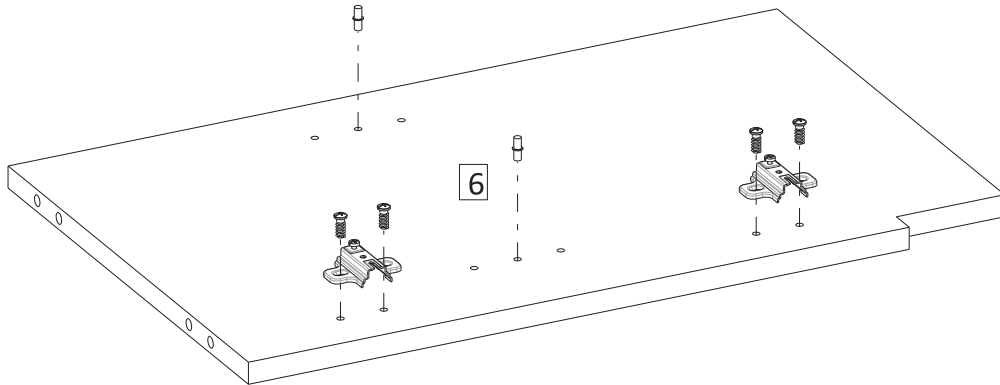
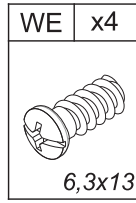
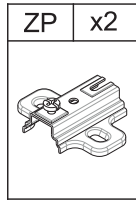
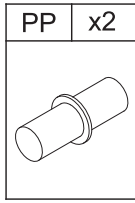
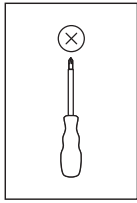
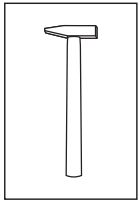

7

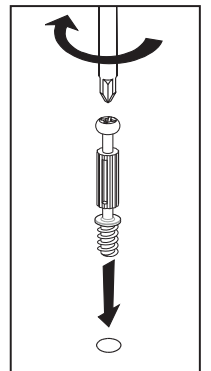
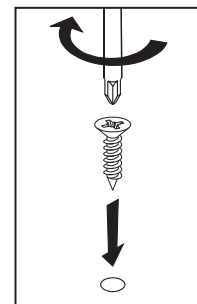
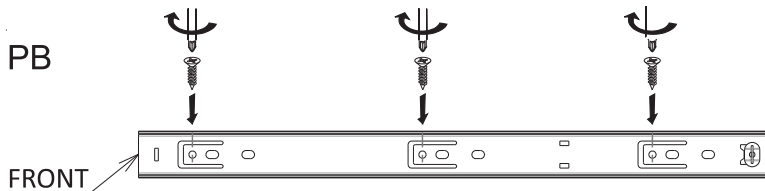
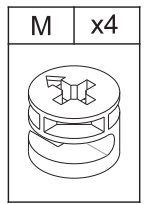
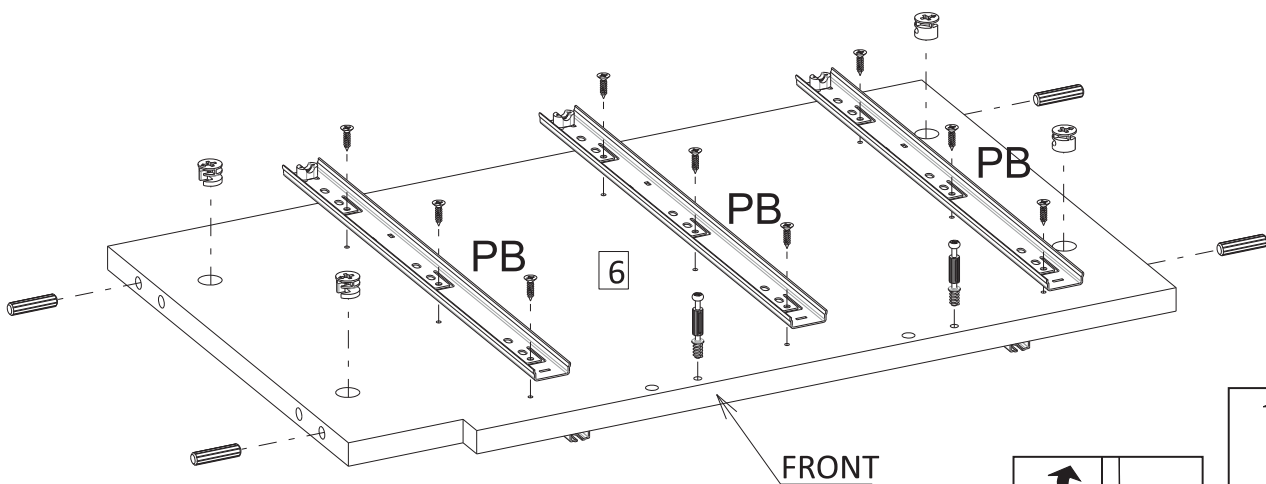
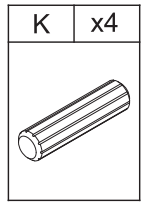
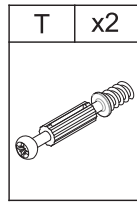
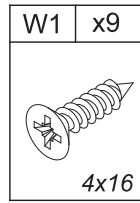
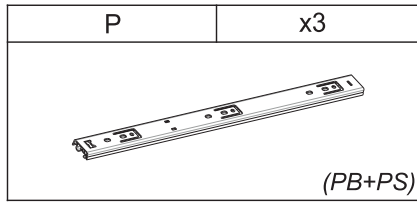
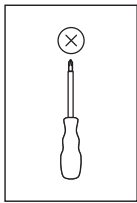
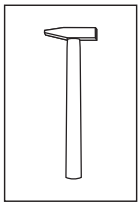

8

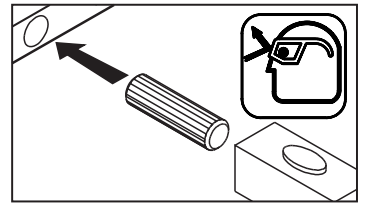
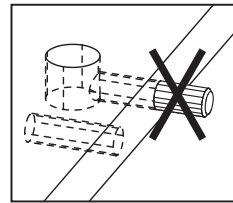
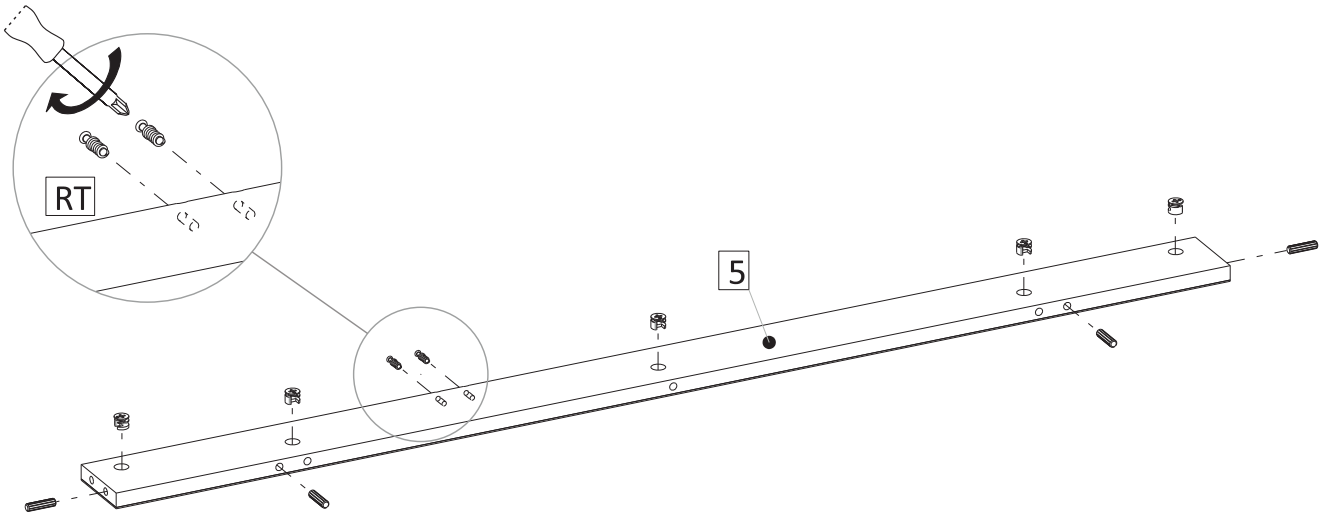
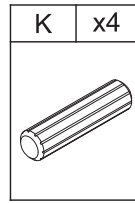
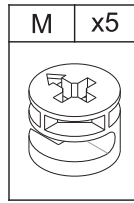
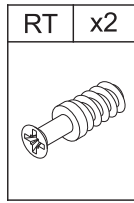
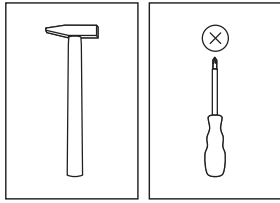

9

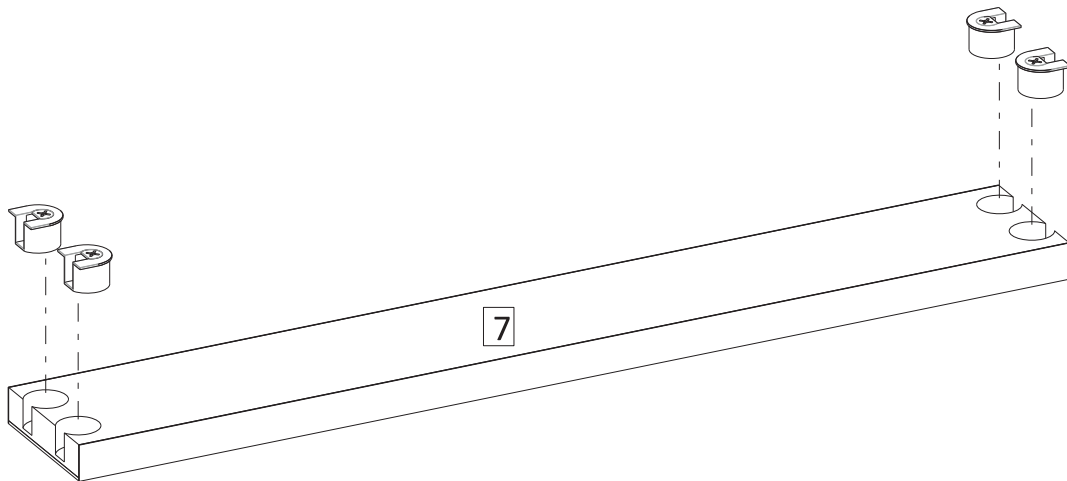
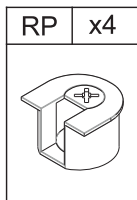

10

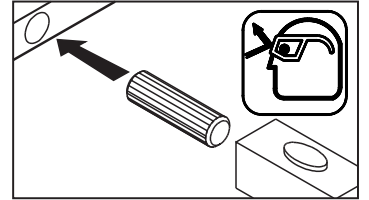
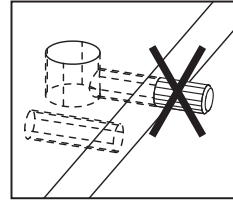
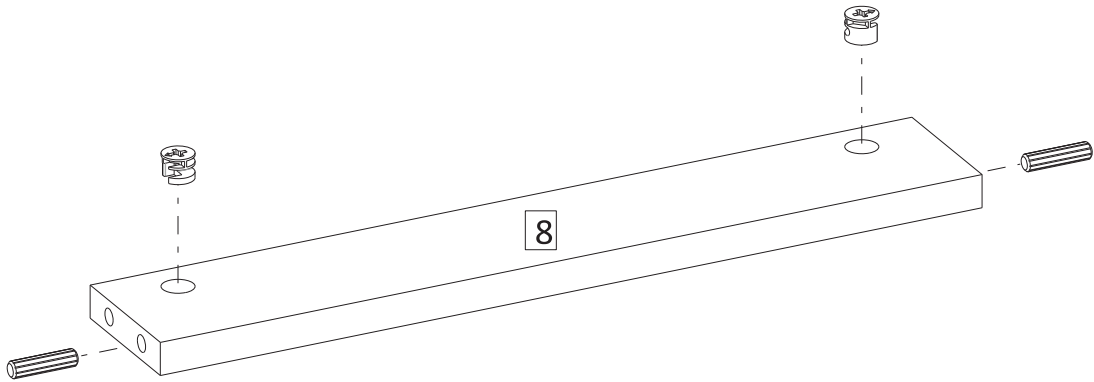
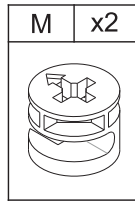
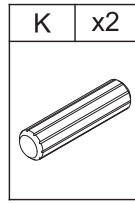
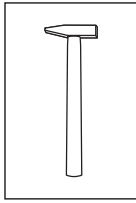

11

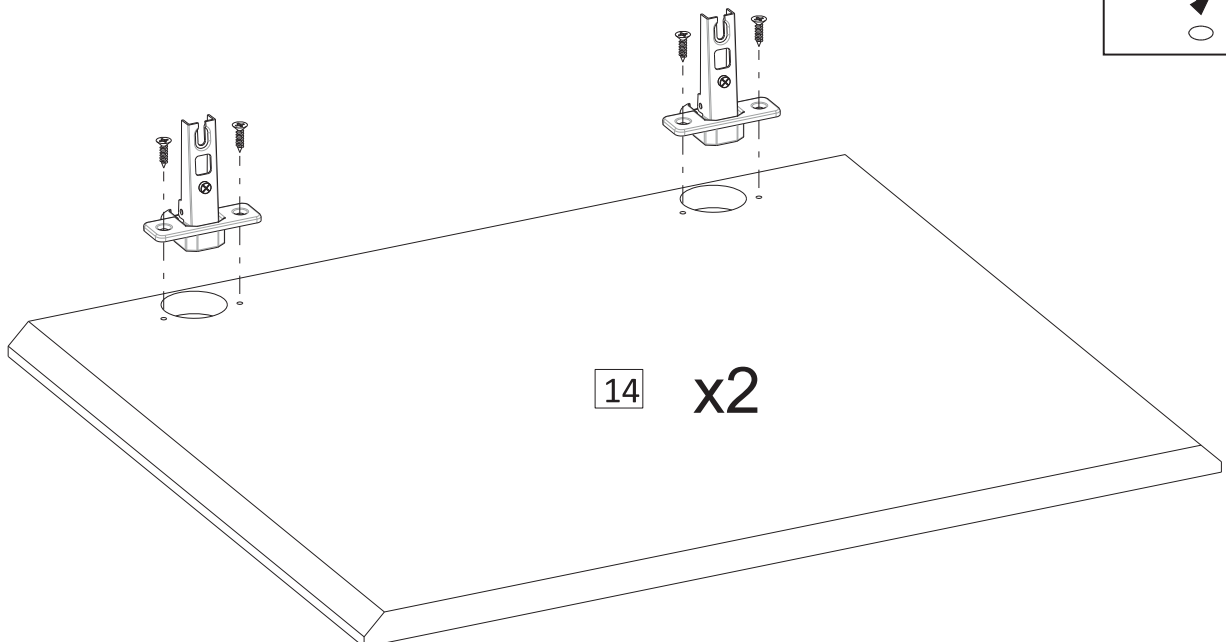
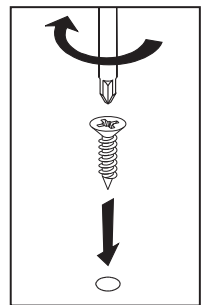
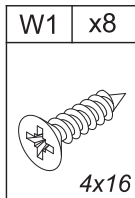
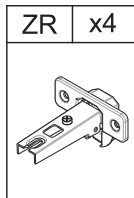
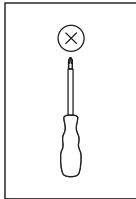

12

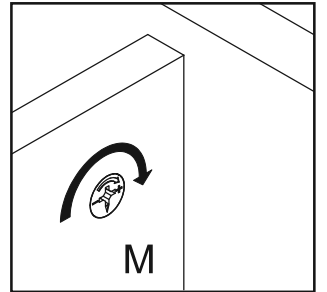
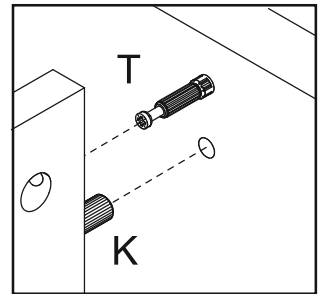
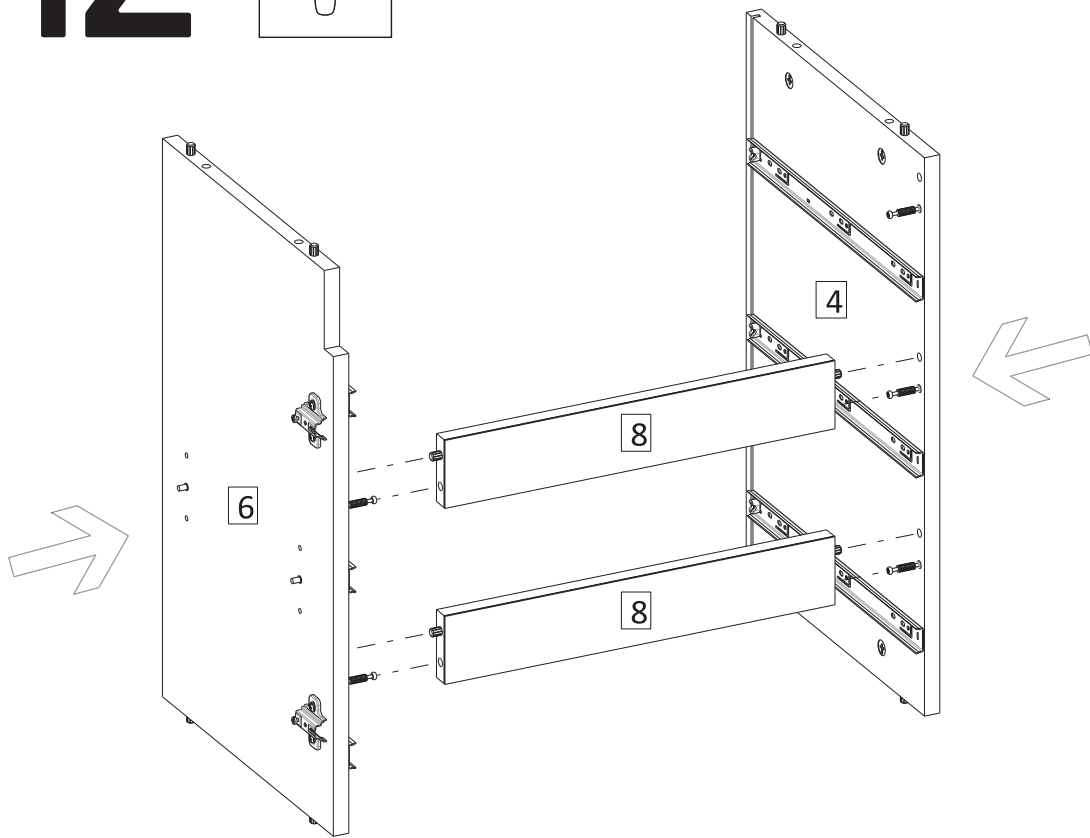
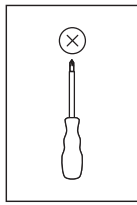

13

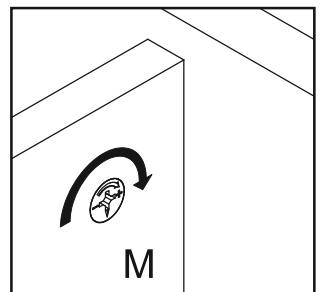
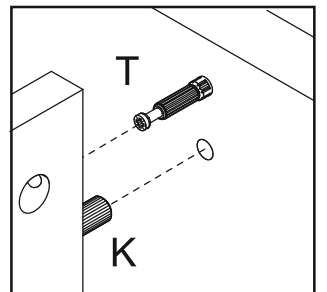
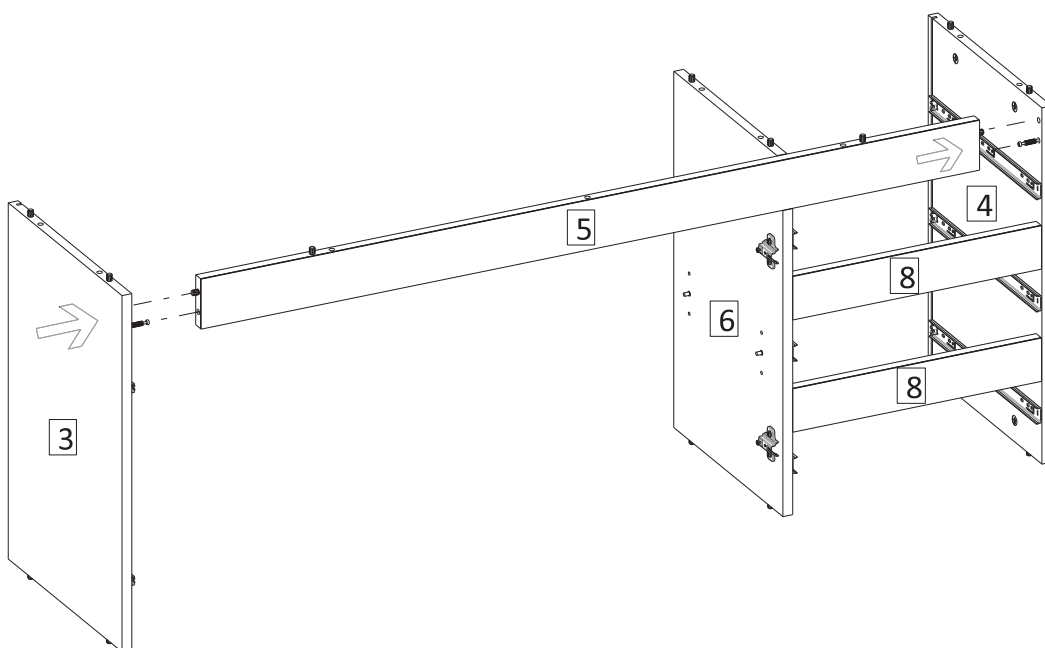
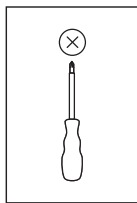

14

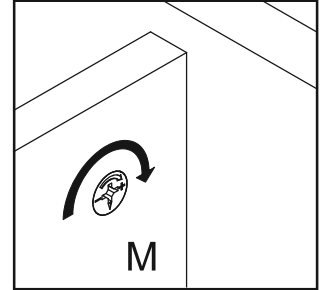
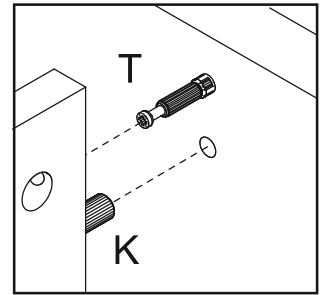
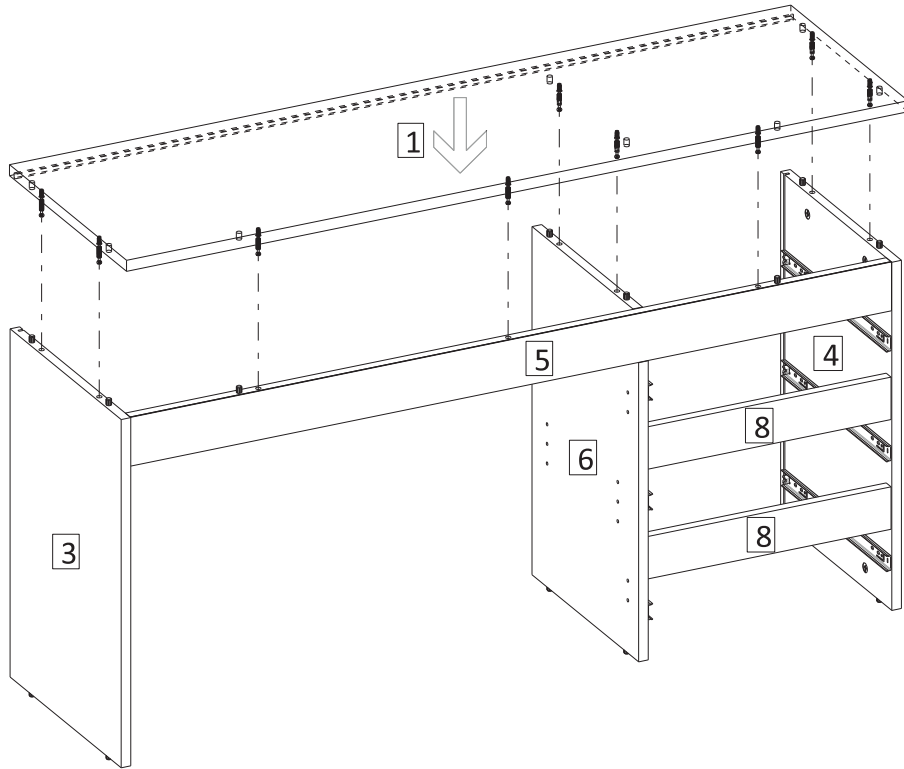
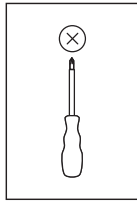

15

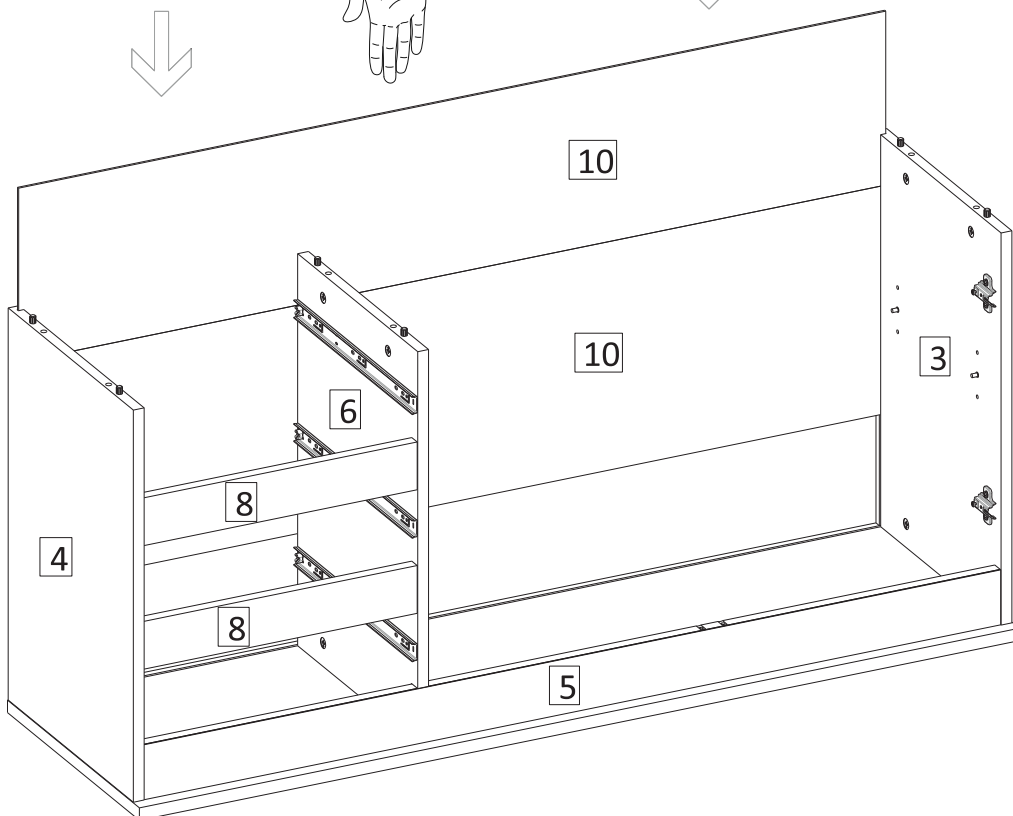
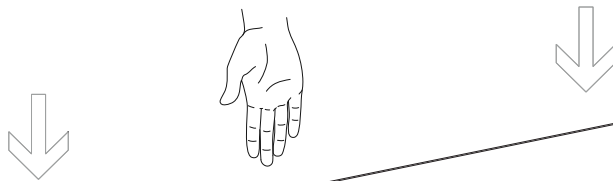

16

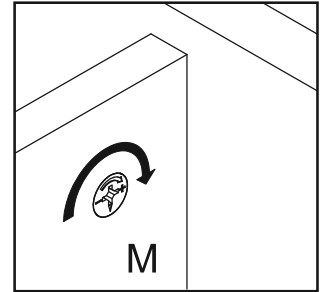
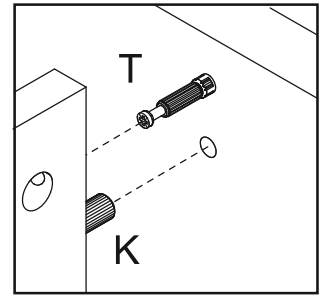
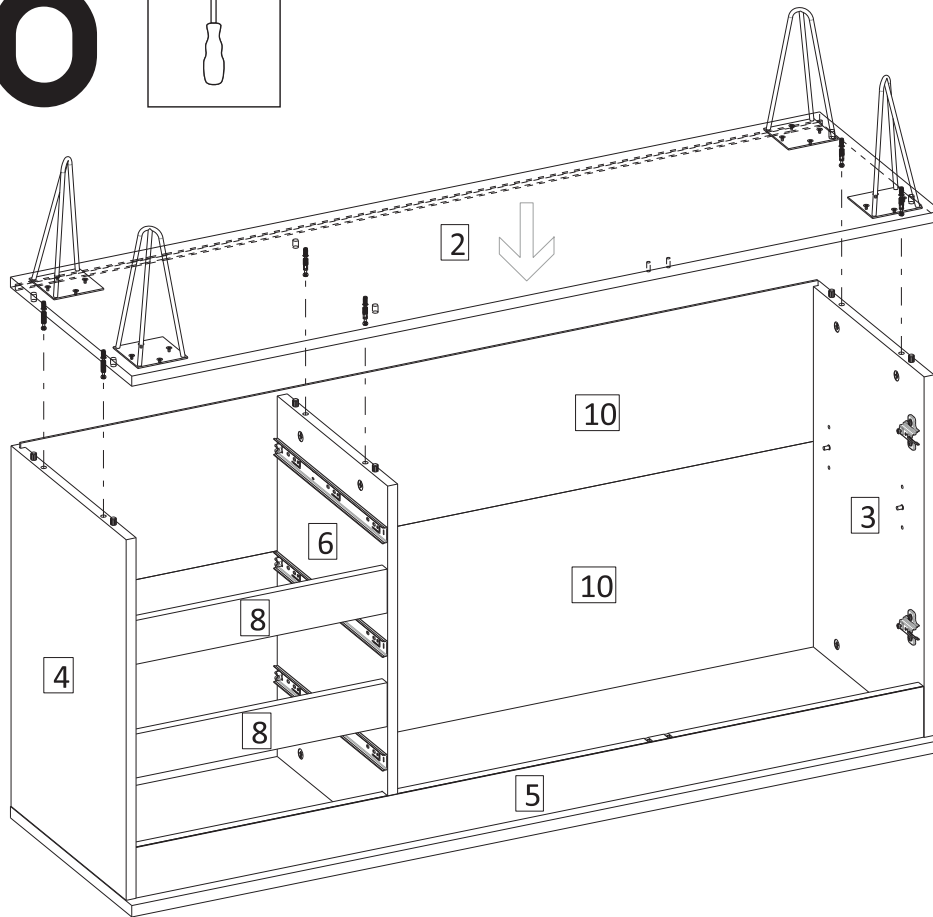
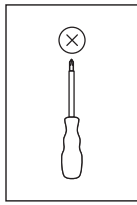

17

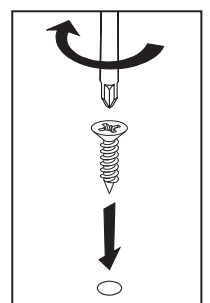
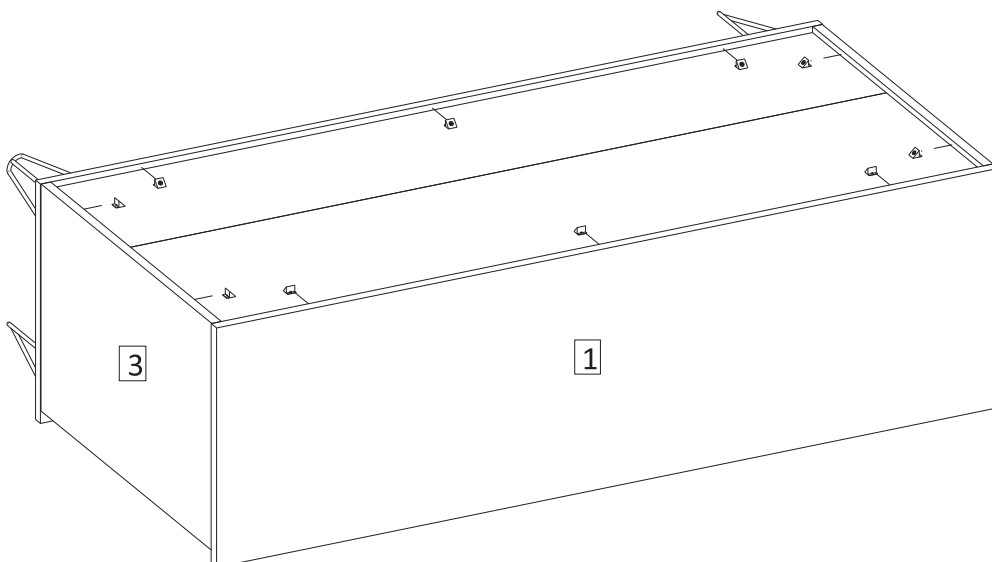
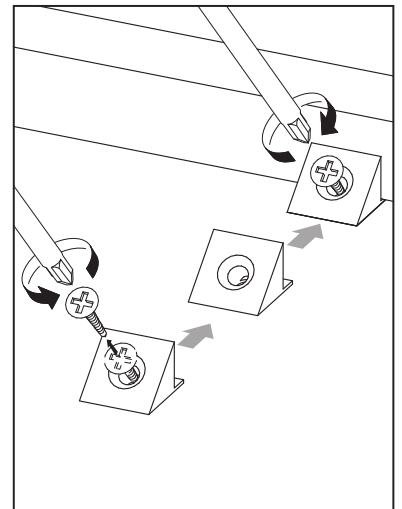
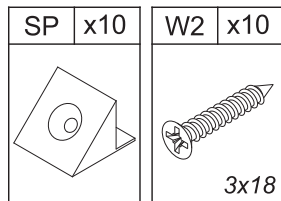
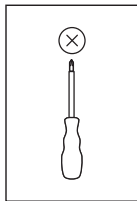

18

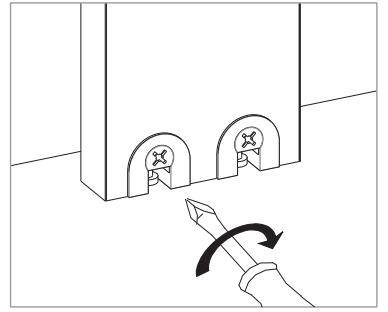
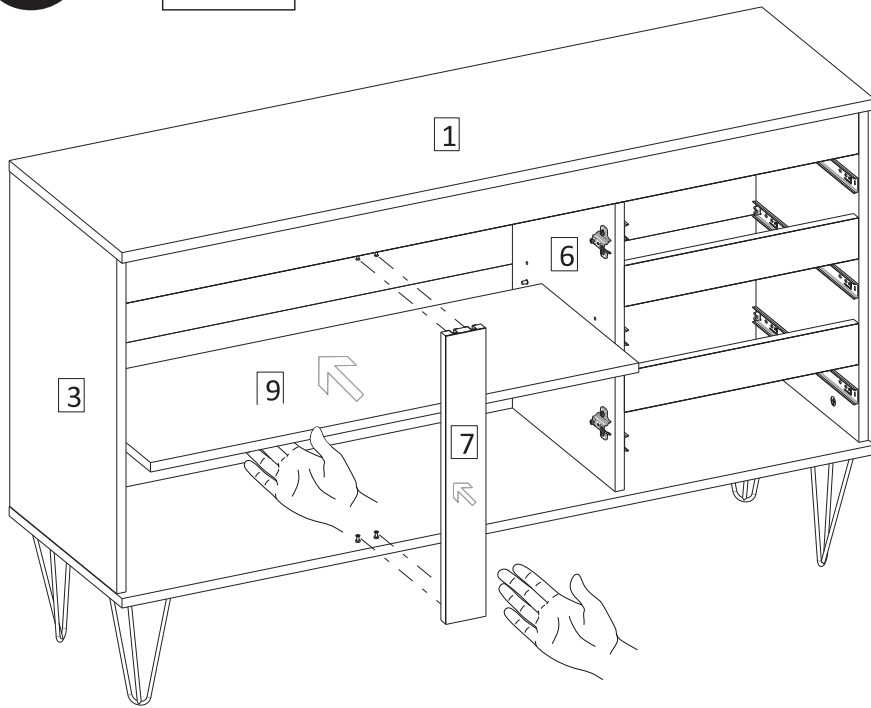
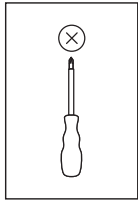

19

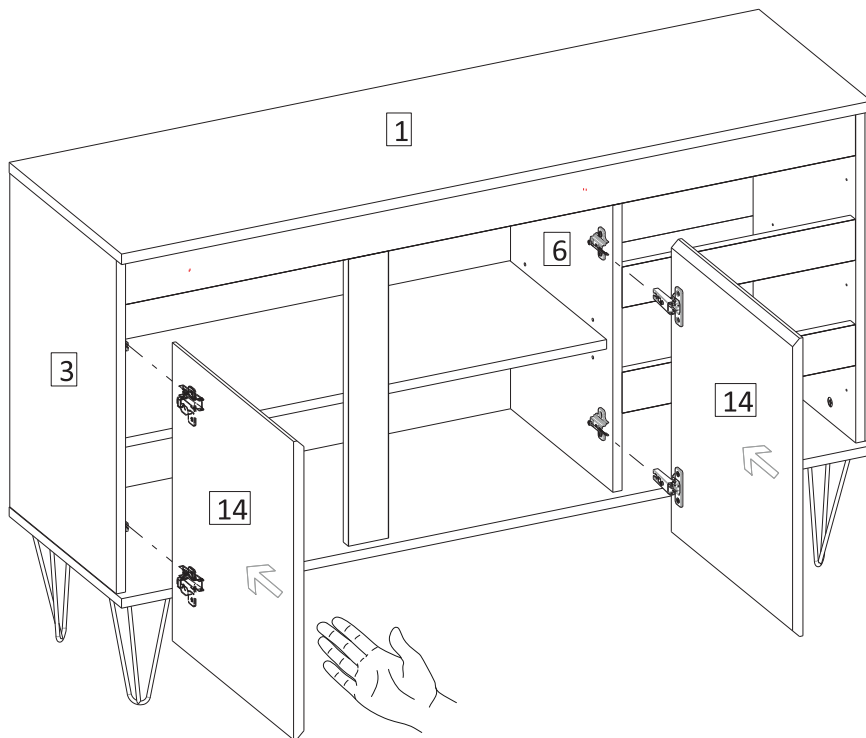
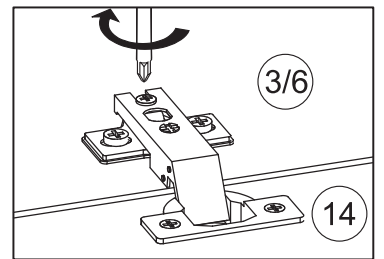
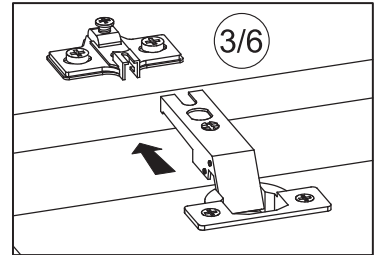
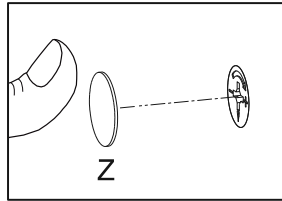
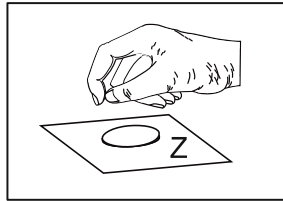
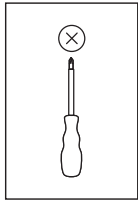

20

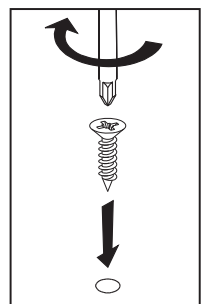
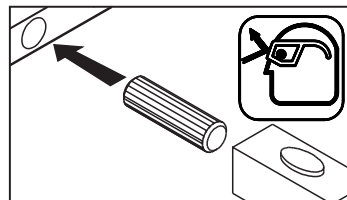
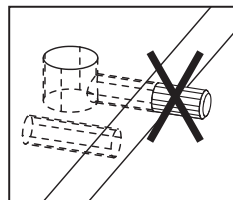
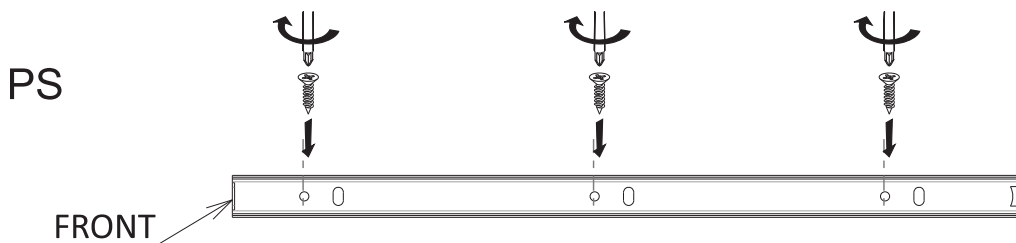
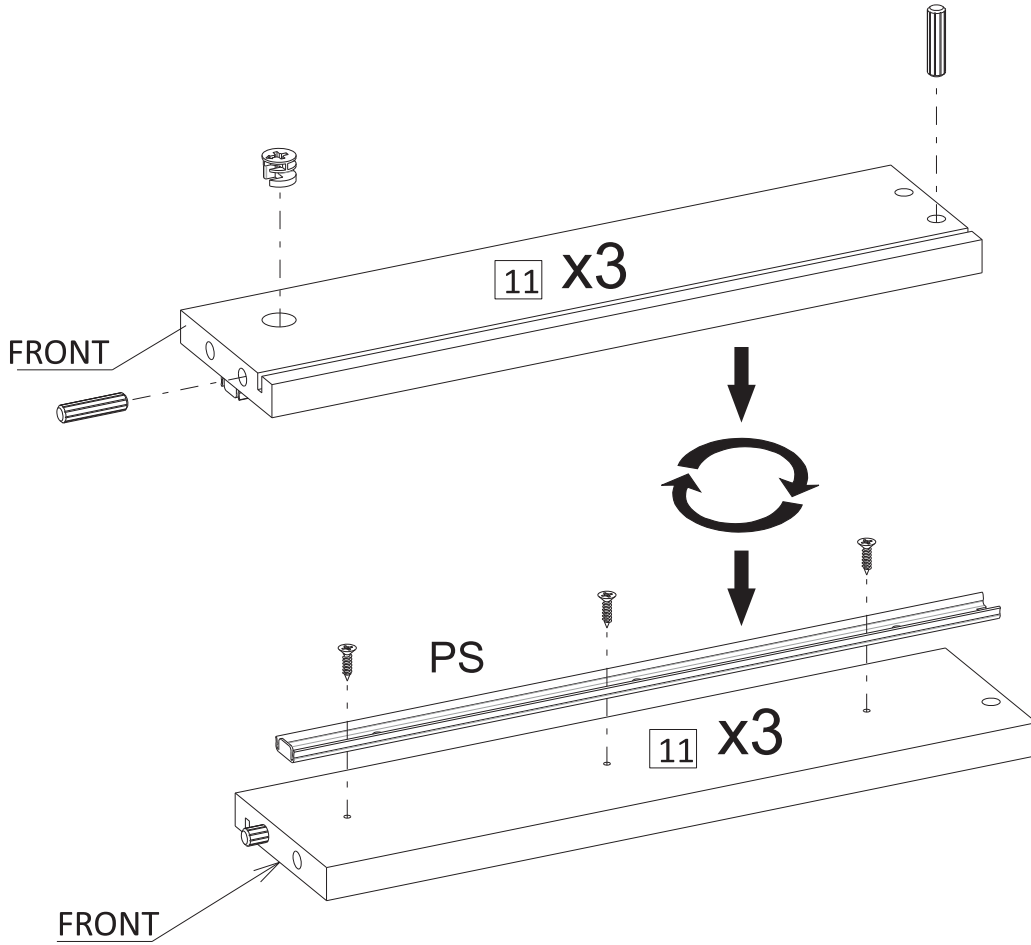
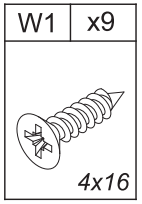
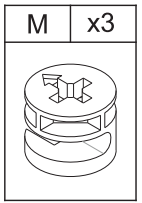
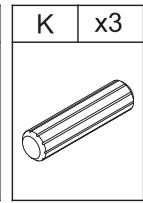
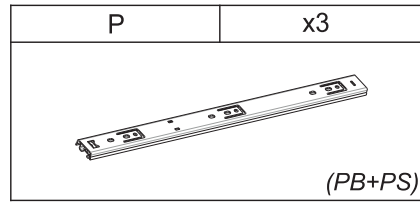
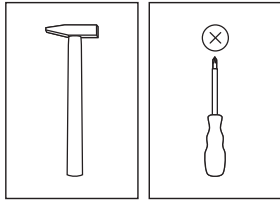

21

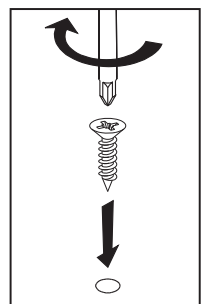
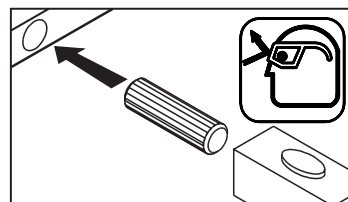
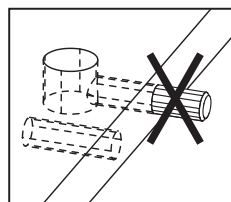
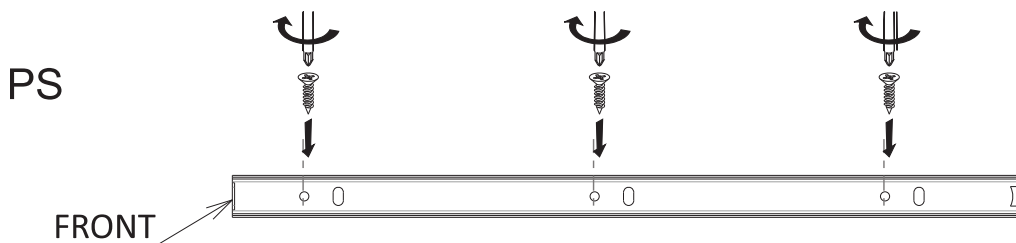
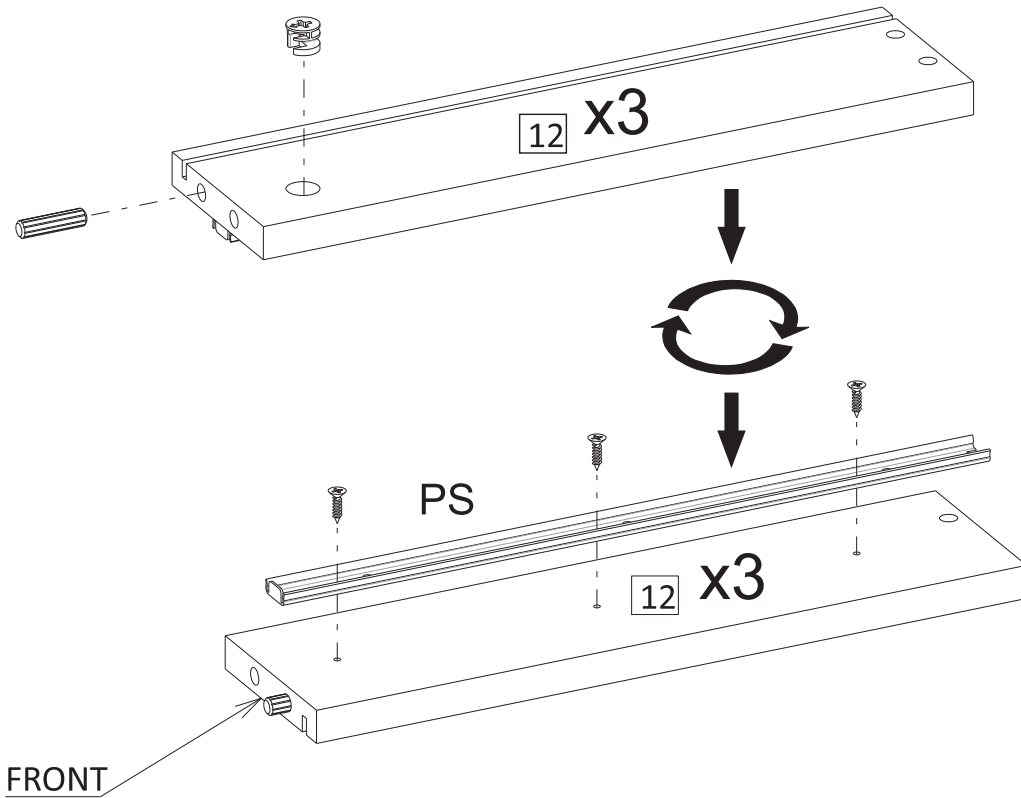
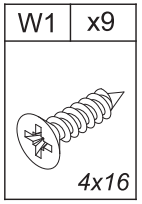
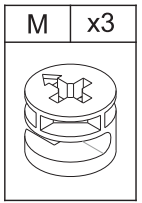
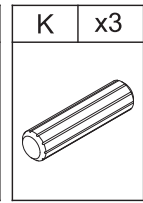
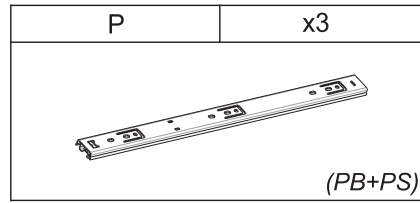
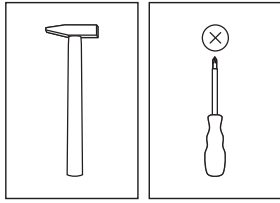

22

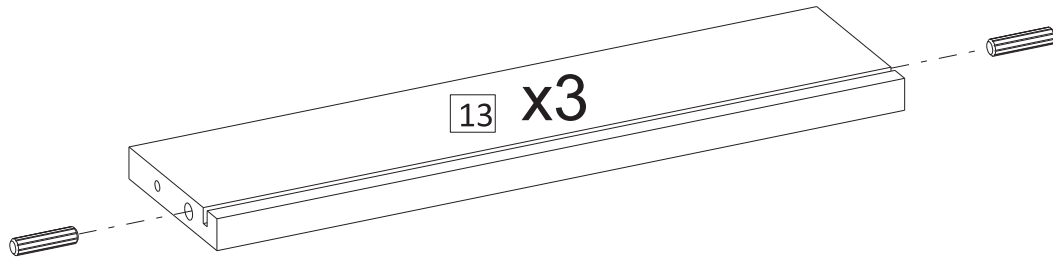
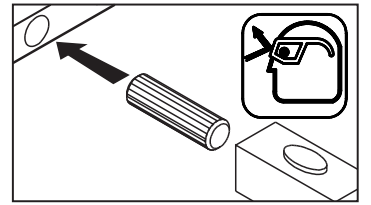
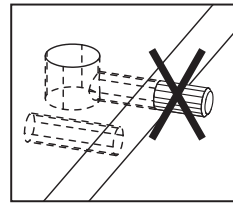
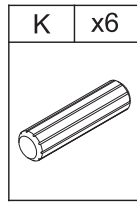
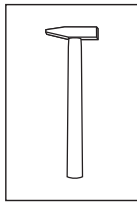

23

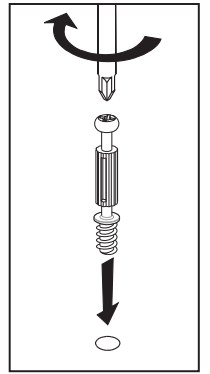
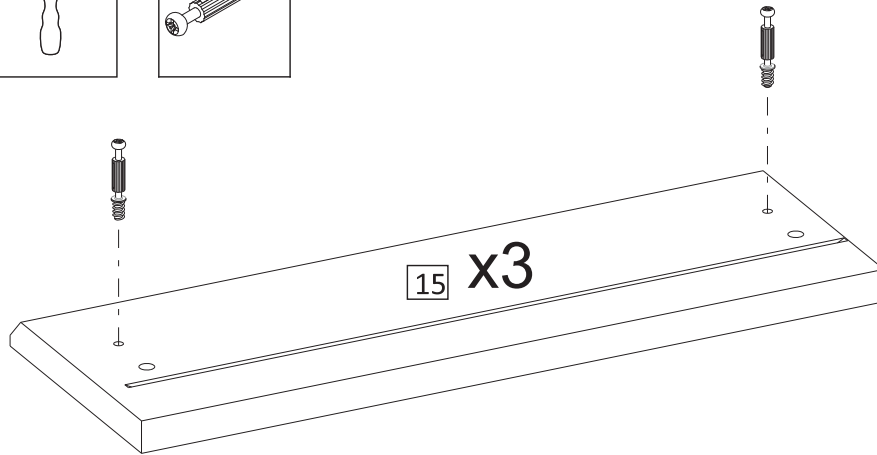
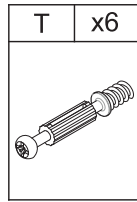
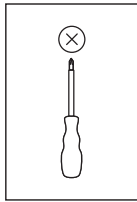

24

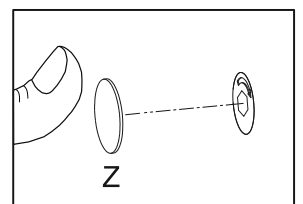
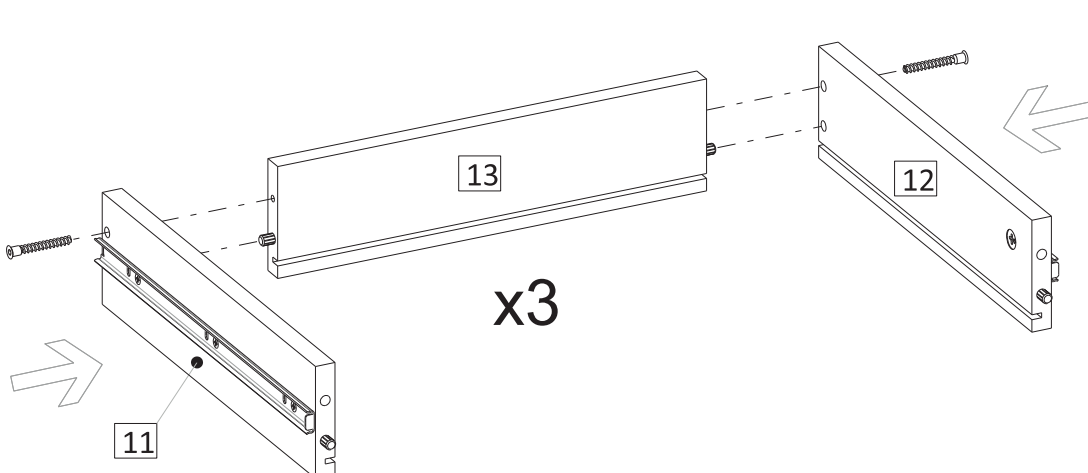
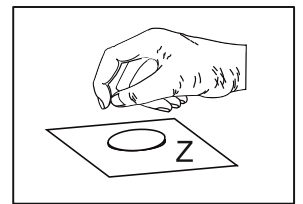
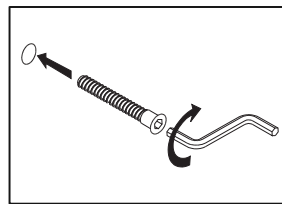
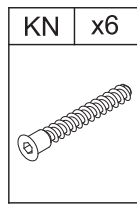
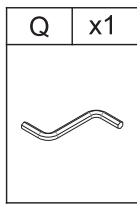

25

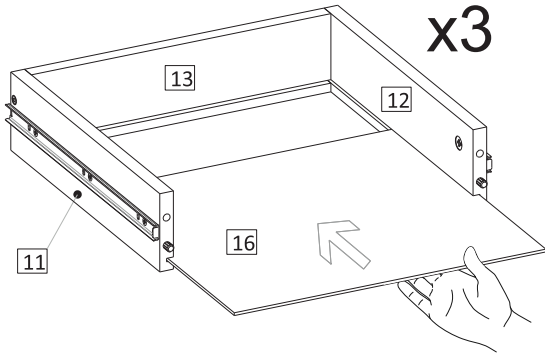

26

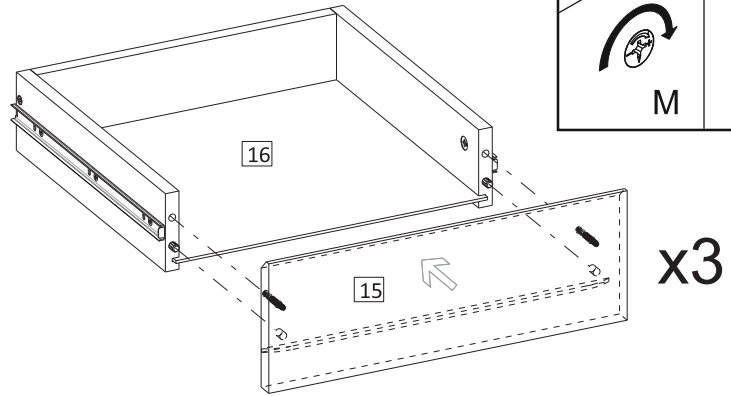
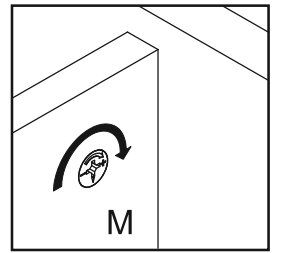
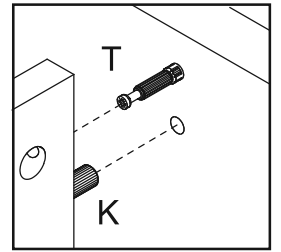
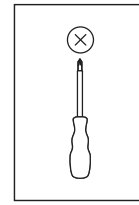

27

