

As this item contains many parts, please read the installation instruction carefully before installation . Please use tools properly and carefully.

---

# Before You Start

- ✓ Read through each step carefully and follow the proper order
  - ✓ Separate and count all your parts and hardware
  - ✓ Give yourself enough room for the assembly process
  - ✓ Have the following tools: Allen Wrench
  - ✓ Caution: If using a power drill or power screwdriver for screwing, please be aware of to slow down and stop when screw is tight. Failure to do so may result in stripping the screw. (Assembly speed can be increased by using electric screwdriver)
- 

# Helpful Hints

## PEOPLE NEEDED FOR ASSEMBLY: 1-2

---

- Open your item in the area you plan to keep it to avoid excessive heavy lifting.
- Identify, sort and count the parts before attempting assembly.
- Do NOT use harsh chemicals or abrasive cleaners on this item.
- Never push, pull, or drag your furniture.



---

# Part List

Ax1

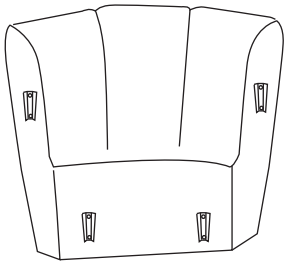

Bx1

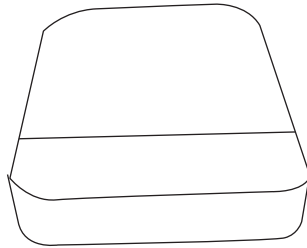

Cx1

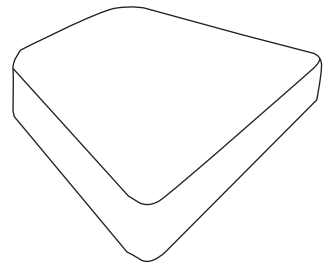

Dx1



Ex1



Fx1

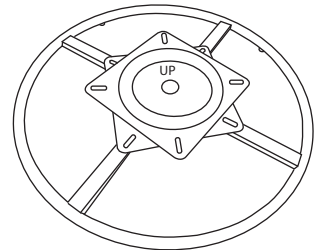

---

# Part List

M6x14

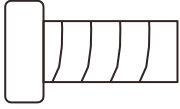

G

X4+1

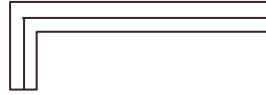

H

X1

# STEP1

---

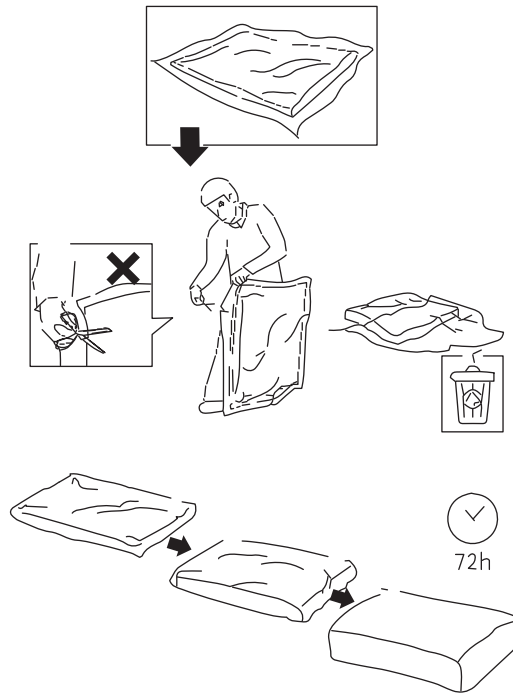

# STEP2

---

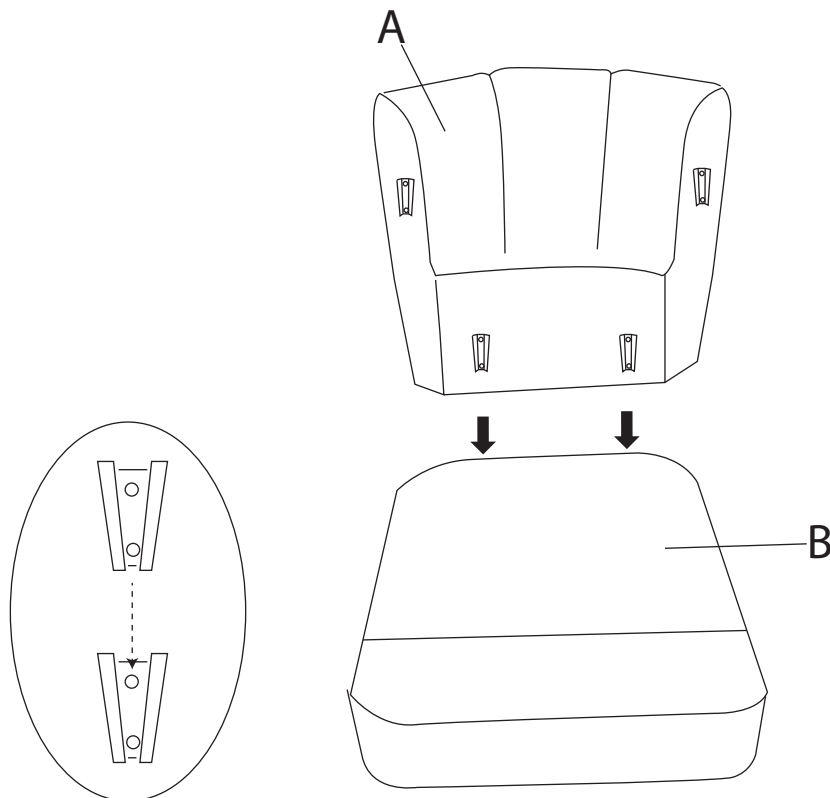

### STEP3

---

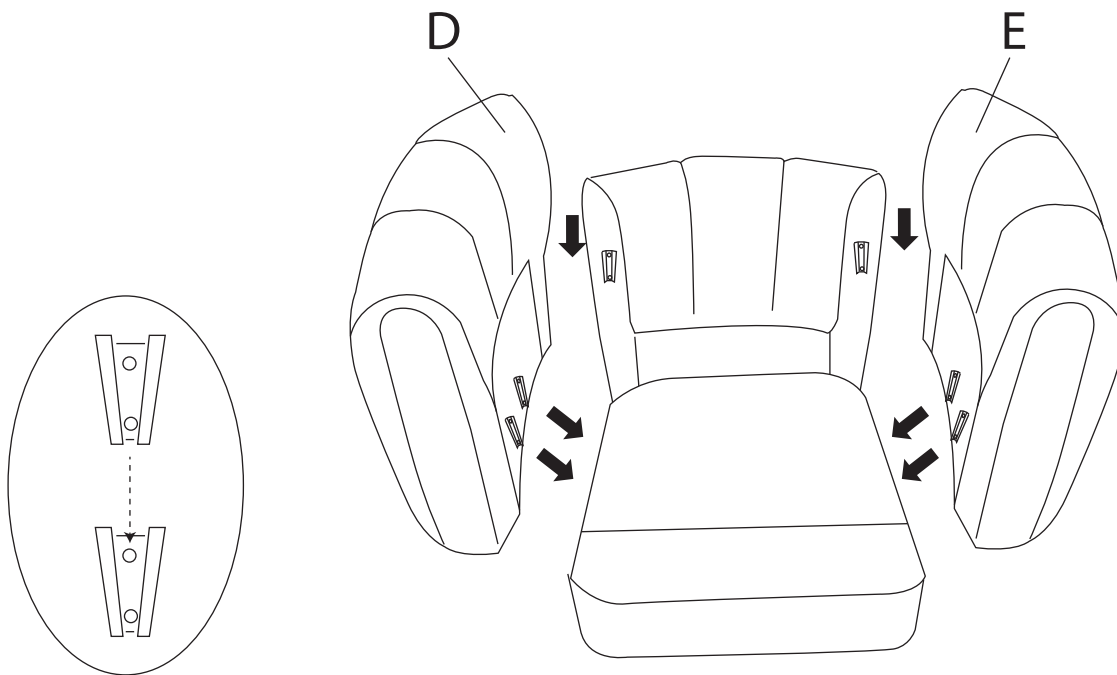

### STEP4

---

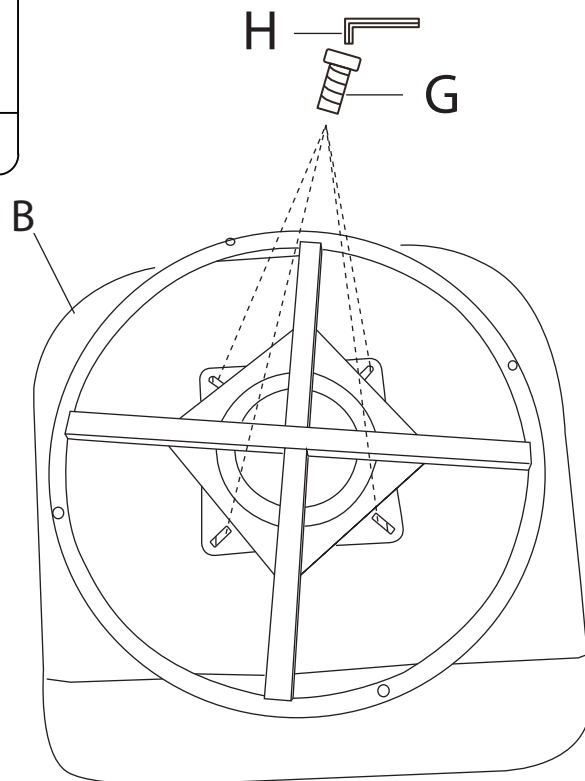
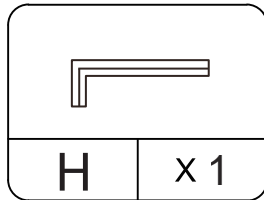
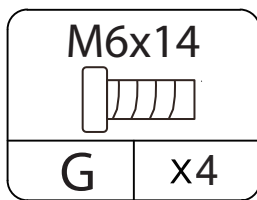

## STEP5

---

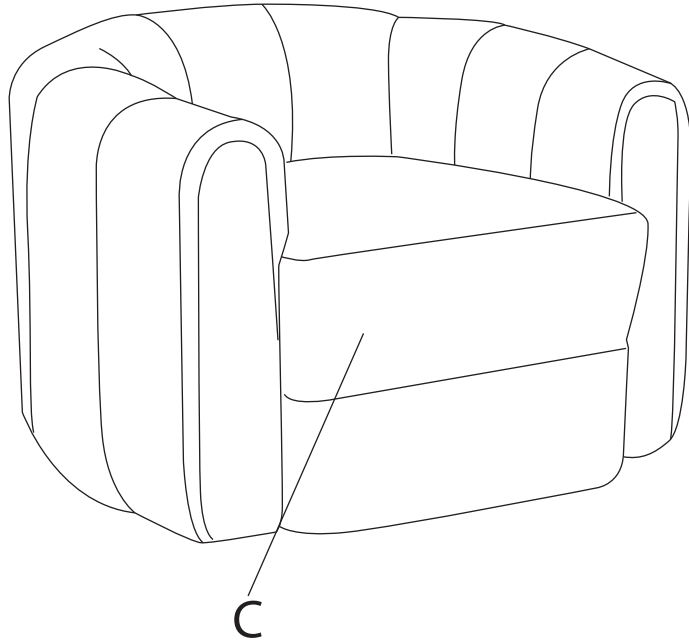

## STEP6

---

