

- 1 Unscrew the screws in order to separate the supporting plate from the disc.

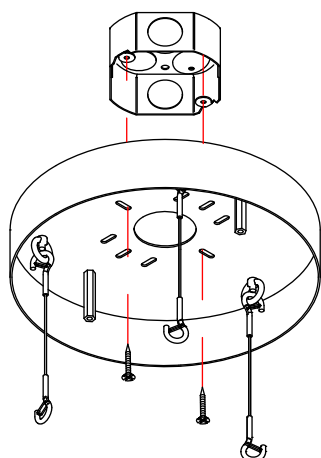

- 2 Fix the canopy to the junction box on the ceiling.
Hang the eyebolts on the plate using the hooks.

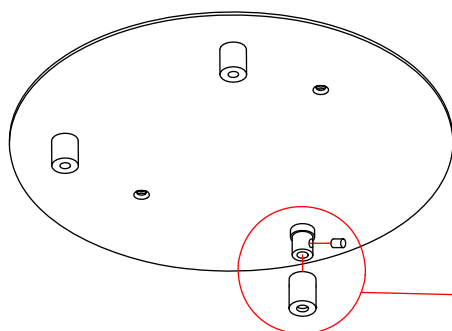
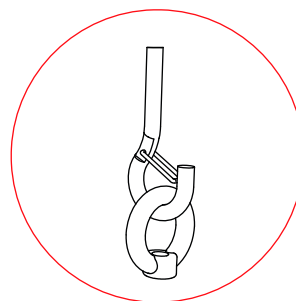

- 3 Unscrew the grain and the cable locks and insert the lamp cable

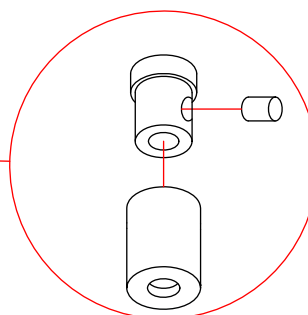

KIKI ROUND CLUSTERS

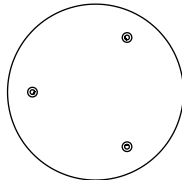
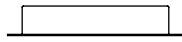

Cluster Ø300mm / Ø11.8"

3 suspensions

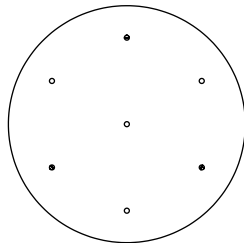
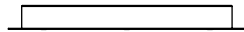

Cluster Ø500mm / Ø19.7"

7 suspensions

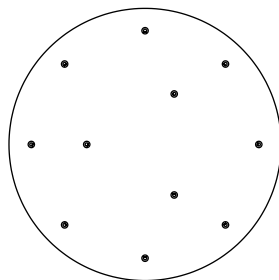
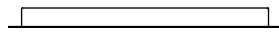

Cluster Ø700mm / Ø27.5"

11 suspensions

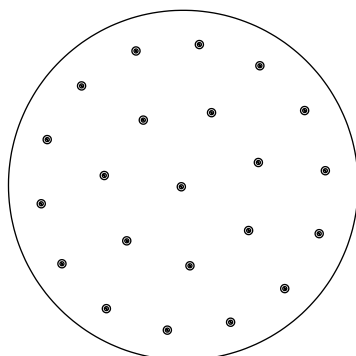
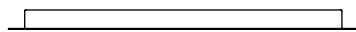

Cluster Ø900mm / Ø35.4"

22 suspensions

KIKI LINEAR CLUSTERS

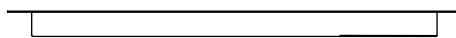

Cluster L.900mm / 35.4"

Up to 6 suspensions

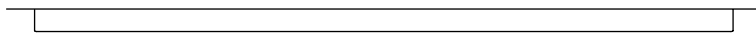

Cluster L.1500mm / 59"

Up to 10 suspensions