

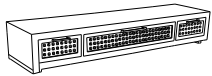

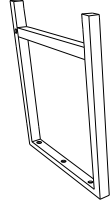

Assembly Instructions

Thank you for your purchase. Before discarding packaging material be sure you have Located all the parts including the necessary hardware and tools listed on the instructions below.
Caution: Read before unpacking assembly parts. Sharp exposed staple tips can cause injury. For your protection please remove any exposed staples used in packaging.

HARDWARE LIST

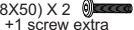
Ax1 	Bx2 	Cx1 	Dx14 (8X50) X 2 +1 screw extra  (8X35) X 12 +2 screws extra 	Ex1  Allen Key
------------------------------------------------------------------------------------------	------------------------------------------------------------------------------------------	------------------------------------------------------------------------------------------	----------------------------------------------------------------------------------------------------------------------------------------------------------------------------------------------------------------------------------------------------	---------------------------------------------------------------------------------------------------------

ASSEMBLY INSTRUCTION

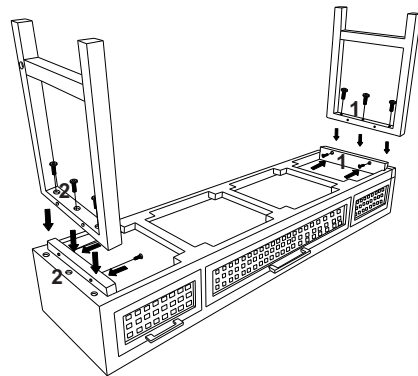

1 Put the wooden body upside down and align legs to the body numerically and tighten them by screw as shown in the picture.

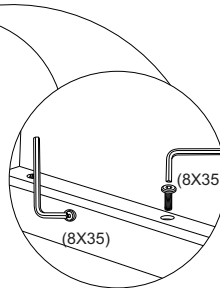

2

Now align supporting strip with legs numerically and tighten them with screw and allen key as shown in the picture.

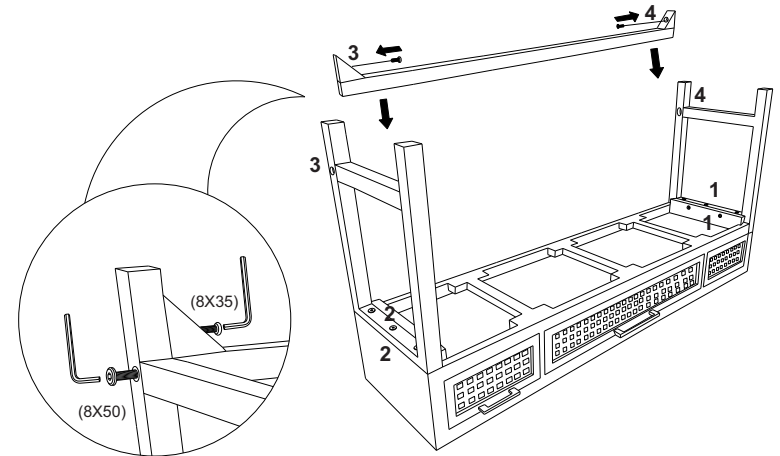
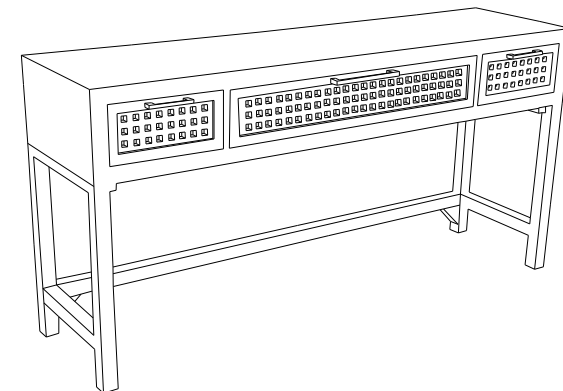

DIAGRAM ASSEMBLY



THANK YOU FOR YOUR PURCHASE