

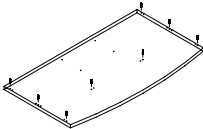

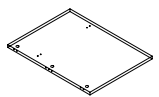

(1) Top  1PCS	(2) End Panel  2PCS	(3) Modesty Panel  1PCS	(A) Dowel  14PCS+1	(B) Cam Pin  12PCS+1	(C) Cam Lock  12PCS+1	(p) Cam Cover  12PCS+1	(D) Leg leveller  4PCS	(D) Grommet  2PCS
--	---	---	--	--	--	--	--	--

STEP 3

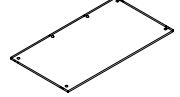
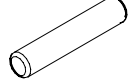
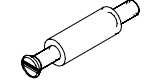

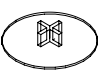
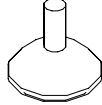
Bow Top Desk Shell

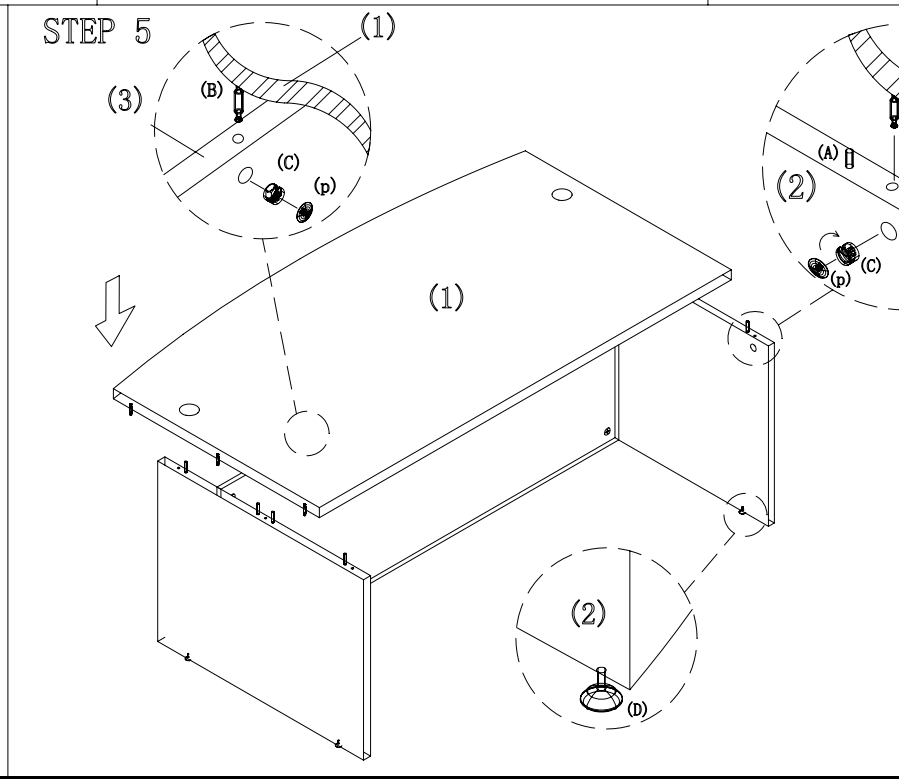
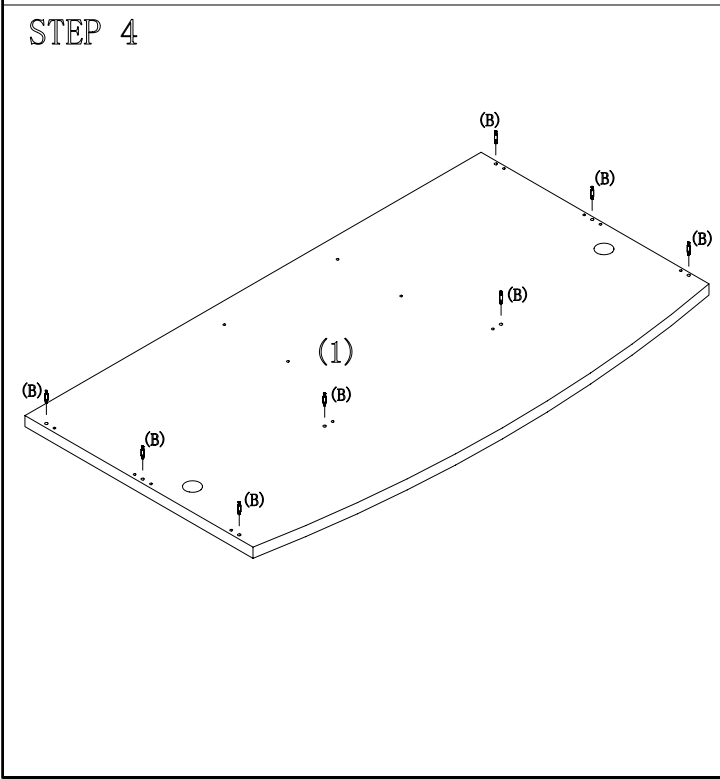
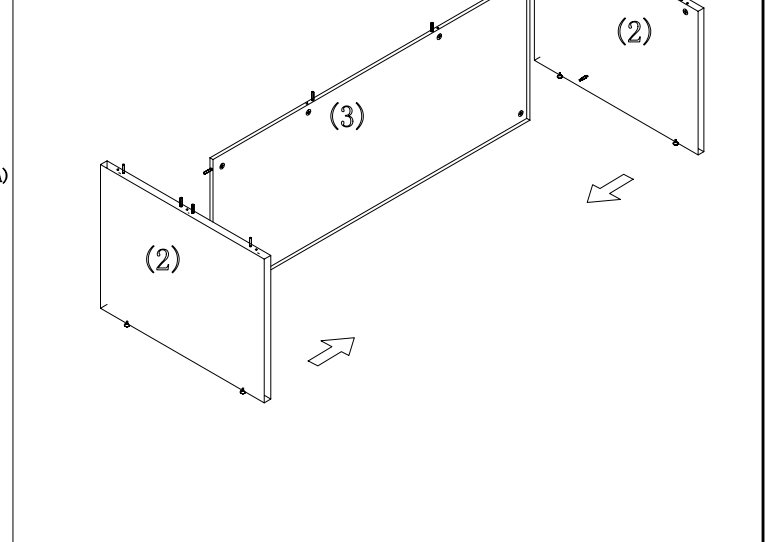
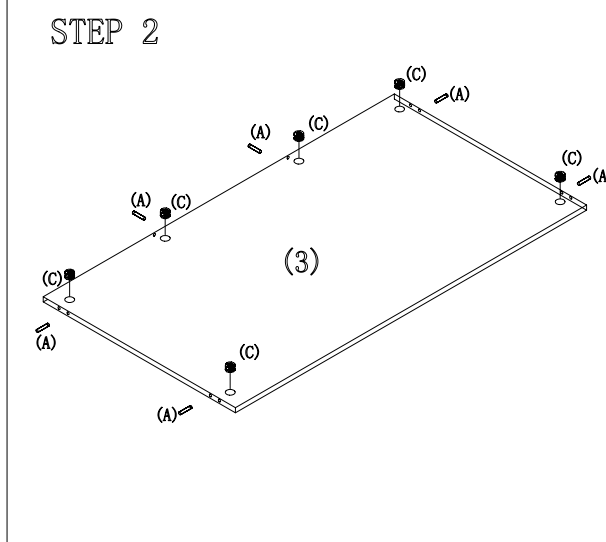
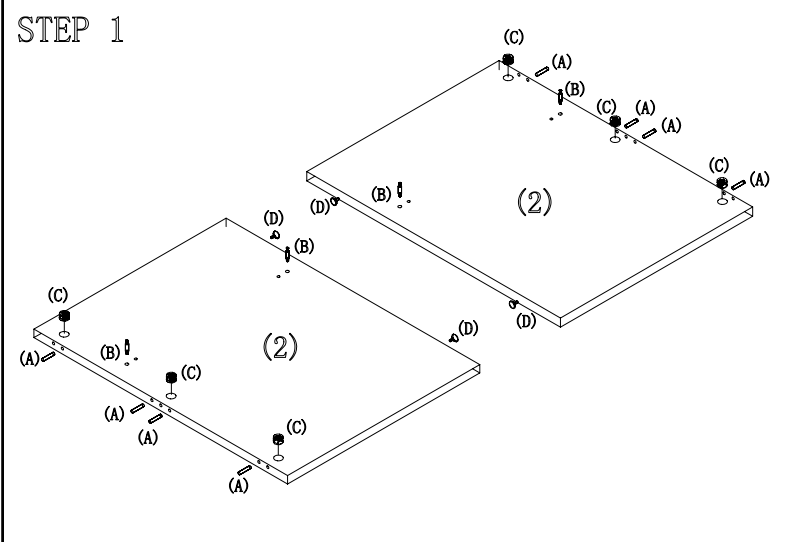
72"W X 36"D X 29"H

Always lay components on A clean, soft-cushioned surface during assembly.