

ASSEMBLY INSTRUCTION

ASSEMBLY TIPS:

- 1.Remove hardware from box and sort by size.
- 2.Please check to see that all hardware and parts are present prior to start of assembly.
- 3.Please follow attached instructions in the same sequence as numbered to assure fast & easy assembly.





Warning!!





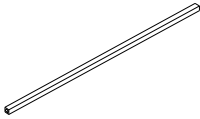

- 1.Don't attempt to repair or modify parts that are broken or defective. Please contact the store immediately.
- 2.This product is for home use only and not intended for commercial establishment.

ASSEMBLY TIME PER UNIT: 25 MINUTES

PARTS IDENTIFICATION

<p>A</p> <p>TOP GLASS  1PC</p>	<p>B</p> <p>TOP FRAME  1PC</p>
<p>C</p> <p>BOTTOM FRAME  1PC</p>	<p>D</p> <p>CROSSBAR  3PCS</p>

HARDWARE PACKAGE

Z	DESCRIPTION	FIGURE	Q'TY
1	SUCTION CUP		4PCS
2	BOLT		3PCS
3	CONNECTING BOLT		3PCS
4	FLOOR PROTECTOR		4PCS
5	ALLEN WRENCH		1PC
6	WRENCH		1PC

STEP 1

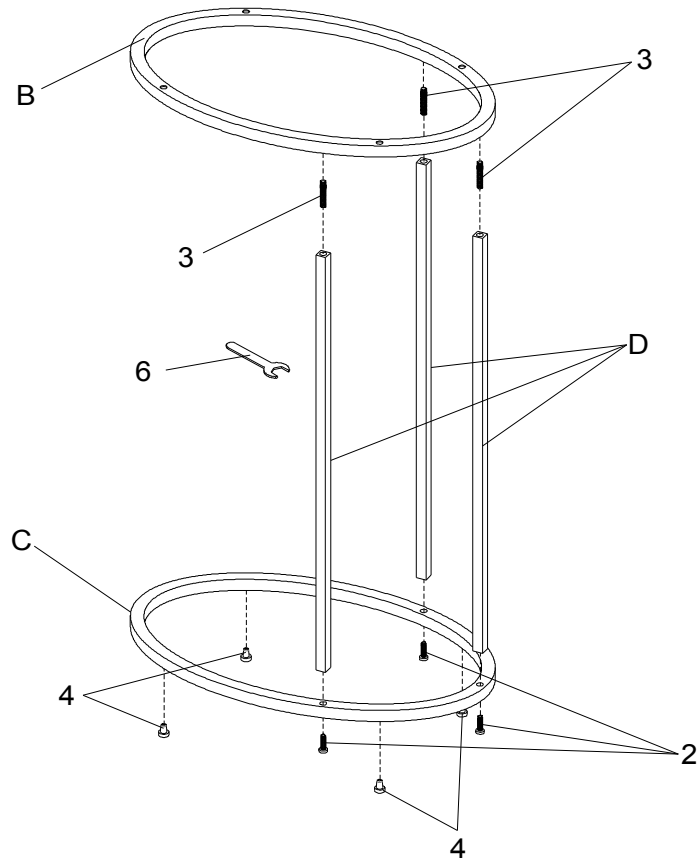

STEP 2

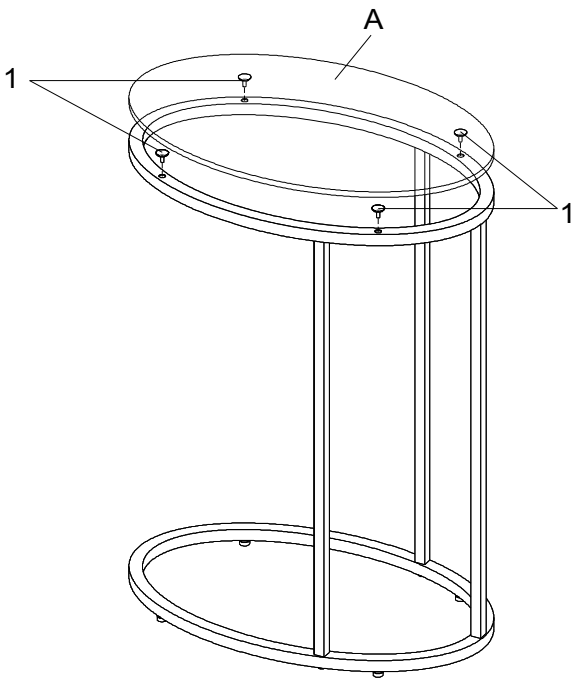

FINISH

