



Fine Furniture for every stage of life

CHAIR

REVISION 0 : 08/01/2018
REVISION 1 : 05/18/2019
REVISION 2 : 05/08/2020
REVISION 3:10/13/2022
REVISION 4:10/26/2023

ASSEMBLY INSTRUCTIONS

ASSEMBLY TIPS:

- 1.Remove hardware from box and sort by size.
- 2.Please check to see that all hardware and parts are present prior to start of assembly.
- 3.Please follow attached instructions in the same sequence as numbered to assure fast & easy assembly.







WARNING !

- 1.Don't attempt to repair or modify parts that are broken or defective. Please contact the store immediately.
- 2.This product is for home uses only and not intended for commercial establishments.



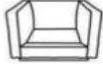

ASSEMBLY TIME 20 MINUTES

PARTS IDENTIFICATION

A		CHAIR	1PC
B		BACK CUSHION	1PC
C		SEAT CUSHION	1PC
D		PATTERNED PILLOW	1PC
E		LEGS	4 PCS

HARDWARE IDENTIFICATION

1	BOLT (M8 x 20MM-BLK)		8PCS
2	FLAT WSAHER (M8-BLK)		8PCS
3	ALLEN WARENCH (6#-BLK)		1PC

ASSEMBLY INSTRUCTIONS

STEP1

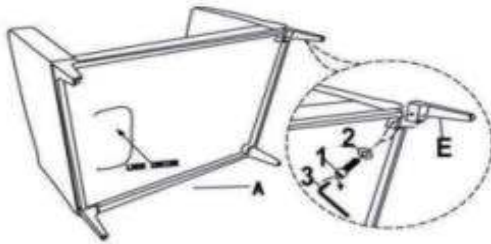

STEP2



STEP3



STEP4

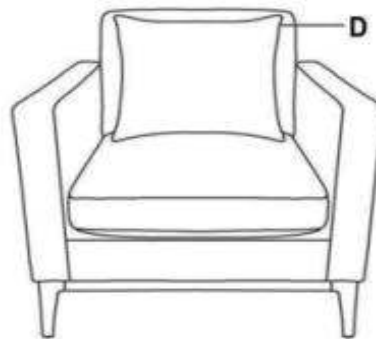

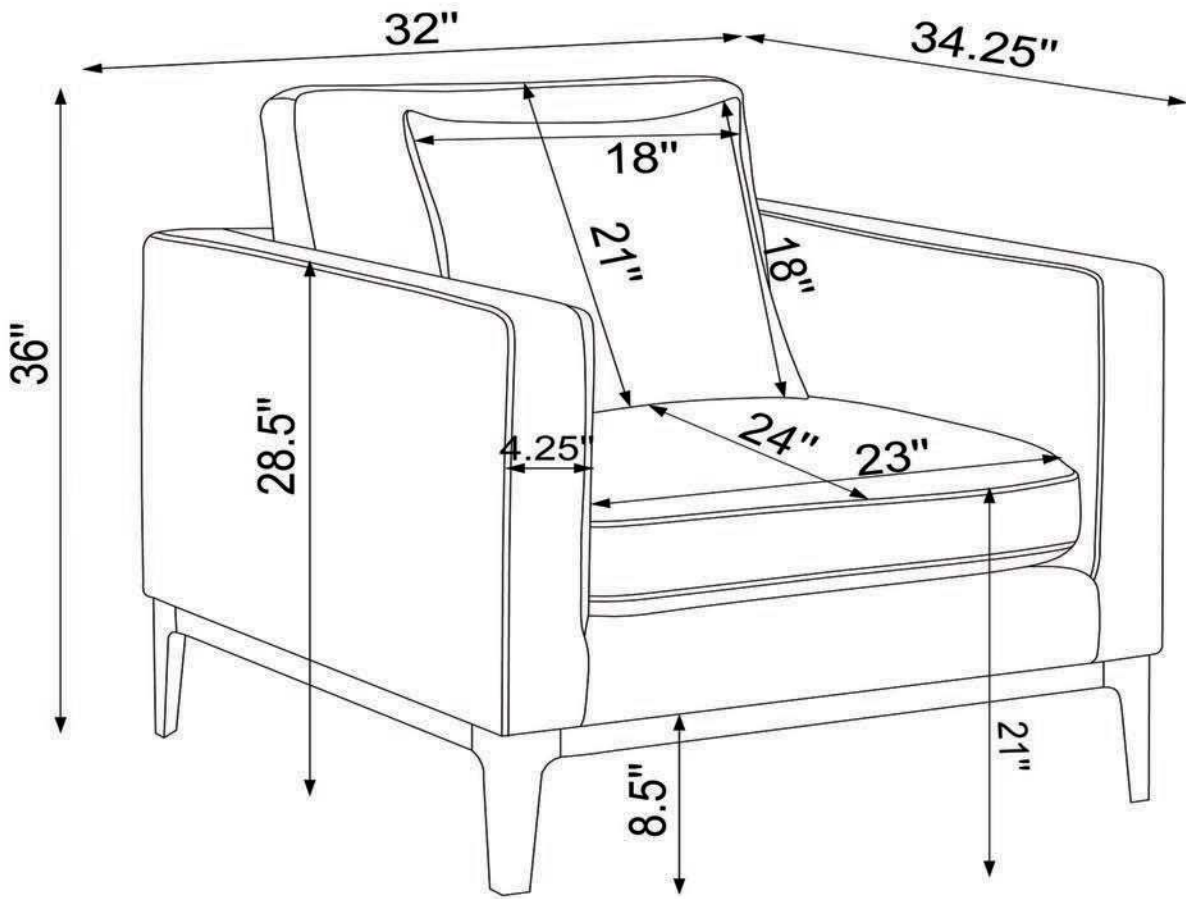

Note : Dimension tolerance $\pm 5\%$