

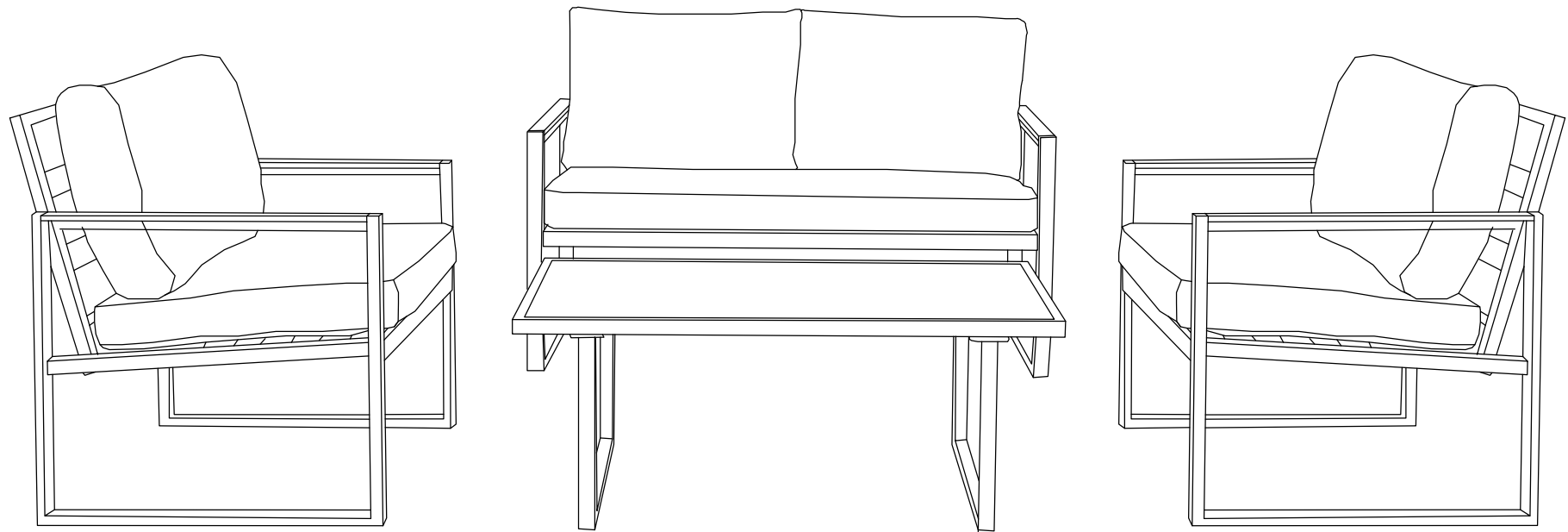

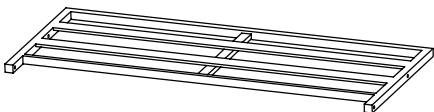

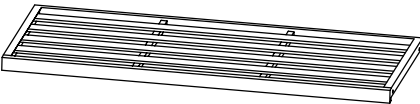

Assembly Instruction

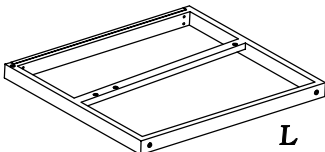
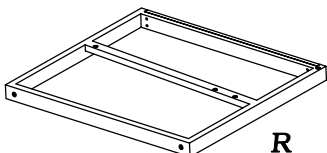

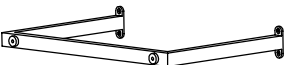
NO.		QTY	NO.		QTY	NO.		QTY
A		1	B		1	C		1
D		1	E		1	F		2
G		1	X1	 M6*30	4	X2	 M6*40	4
X3	 M6*20	8	Y		16	Z		1

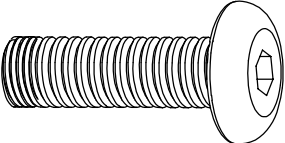
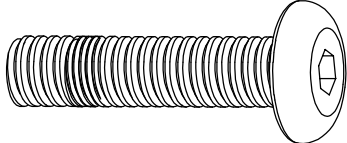
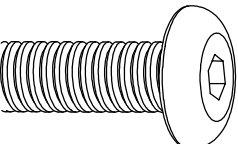
STEP 1

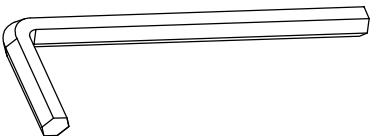
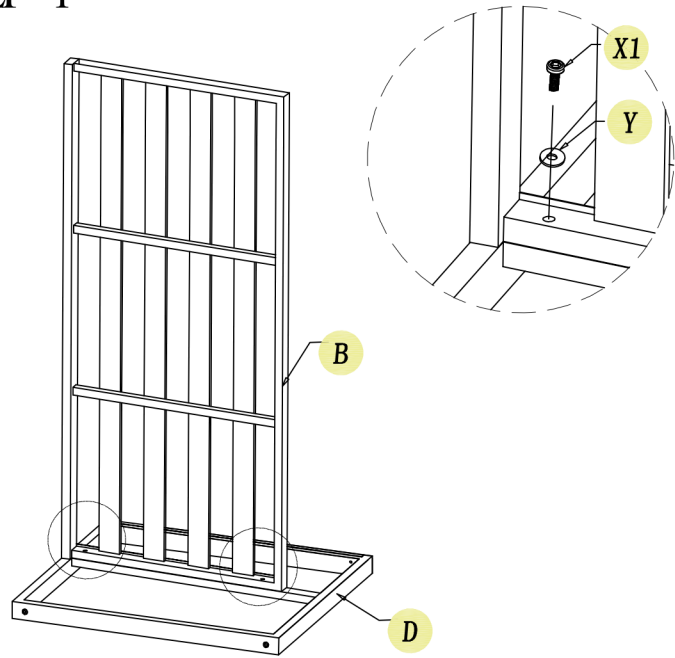

STEP 2

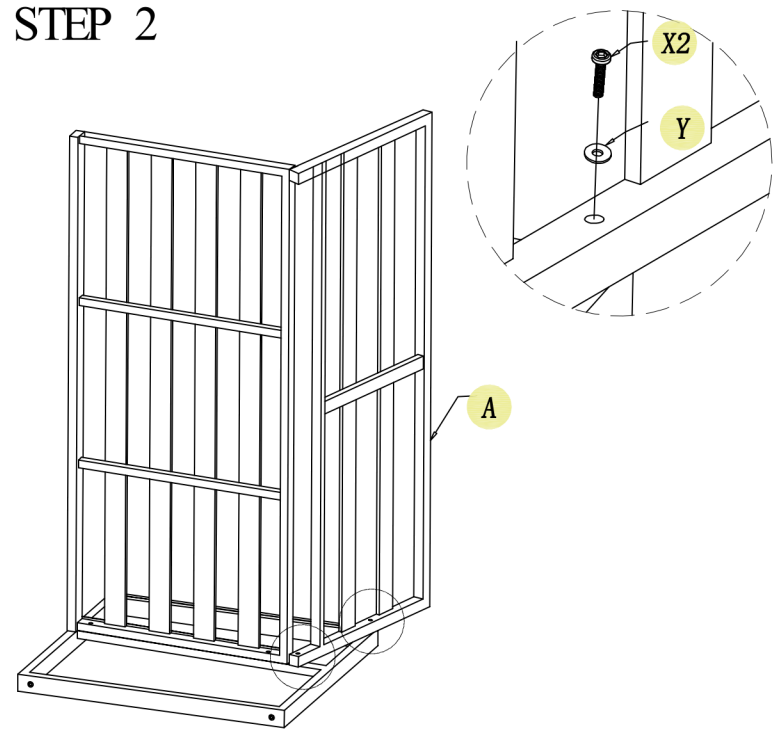

STEP 3

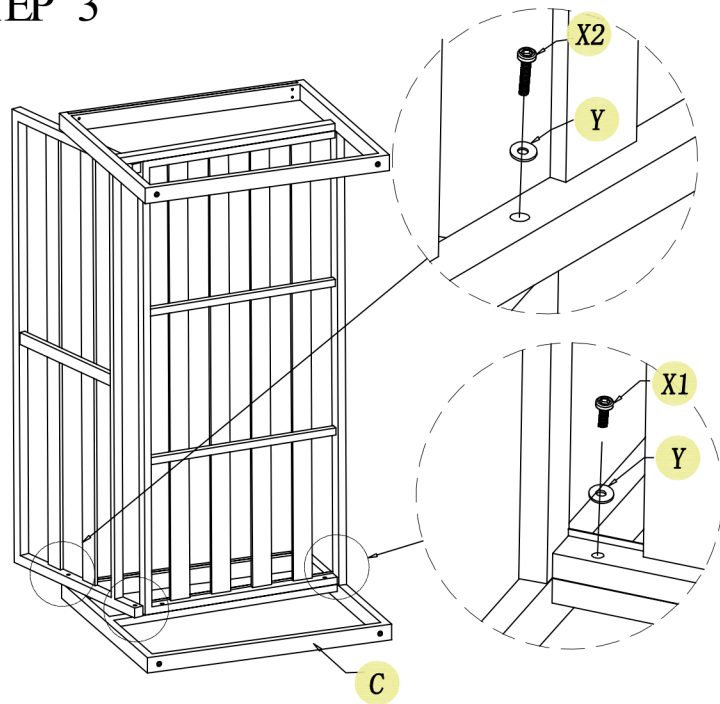

STEP 4

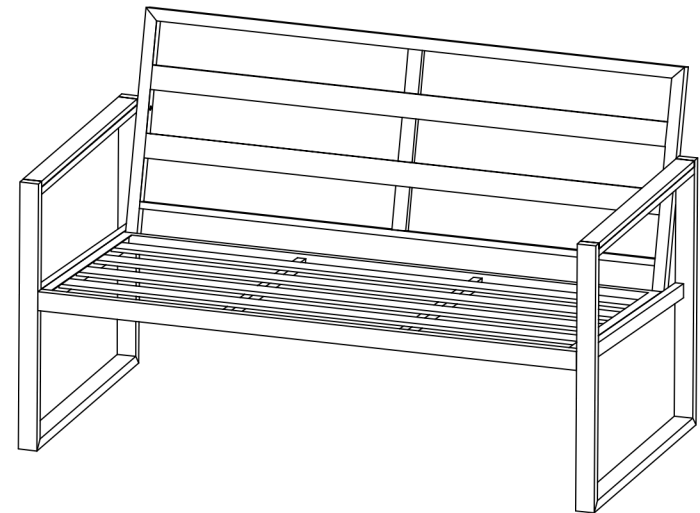

STEP 1

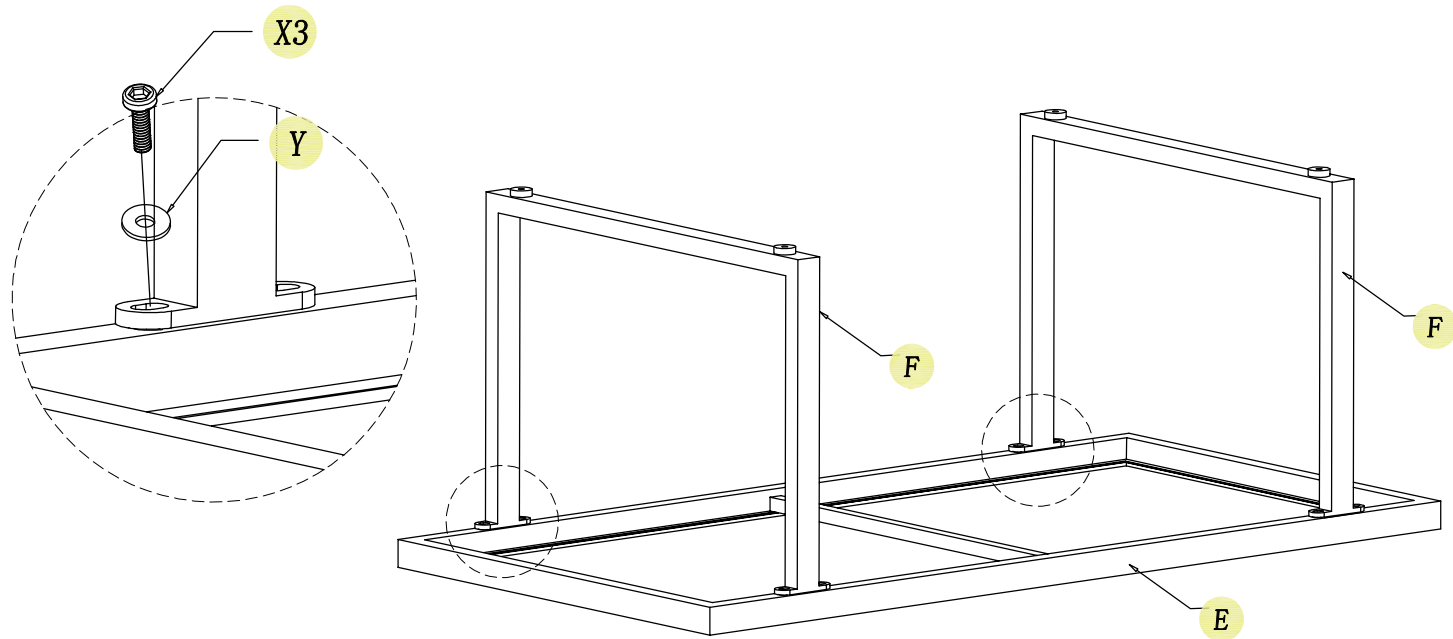

STEP 2

