

ASSEMBLY INSTRUCTION FOR ACME FURNITURE

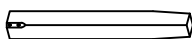



MODEL# DN02915

Thank you for purchasing the quality product. Be sure to check all packing material carefully for small parts which may have come loose inside the carton during shipment. Separate, identify and count all parts and metal hardware. Compare with all parts list to be sure all parts are present. If any part(s) are missing or damaged, please contact your local furniture dealer. For efficient and speedy service, please indicate the model number and code letter of part(s) needed.

*****Do not fully tighten screws until fully assembled*****

DESCRIPTION	COMPONENT PARTS		Q'TY(PCS)
	PART NAME		
①	TOP		1
②	TABLE LEG		4

HARDWARE REQUIRED

Ⓐ		BOLT	M8 X 70MM	8	PCS
Ⓑ		LOCK WASHER	M8 X 22MM	8	PCS
Ⓒ		FLAT WASHER	M8 X 13MM	8	PCS
Ⓓ		ALLEN KEY	M5 X 65MM	1	PCS

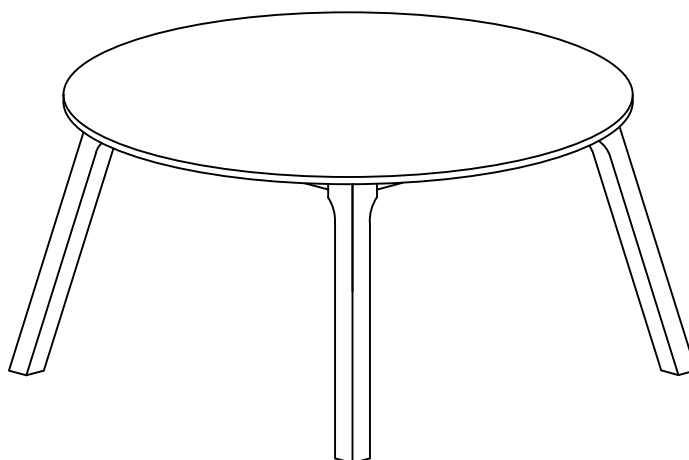

Attention

***Some number parts listed on the instruction sheet may not be in parts bag as they may already be assembled. Carefully check parts and packing materials prior to ordering replacements.

How to assemble:

STEP 1

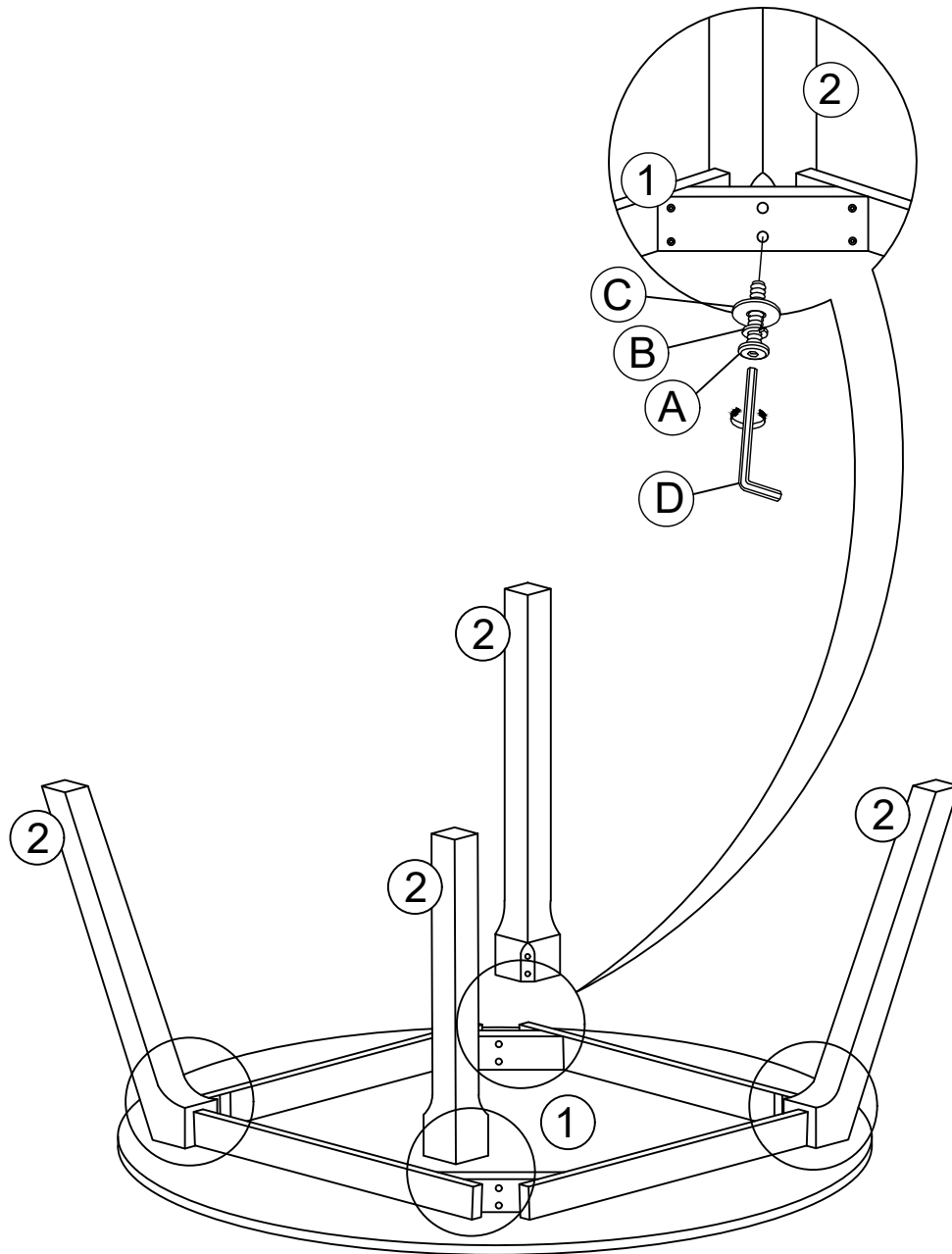





ASSEMBLY INSTRUCTION FOR ACME FURNITURE





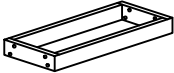

MODEL# DN02916

Thank you for purchasing the quality product. Be sure to check all packing material carefully for small parts which may have come loose inside the carton during shipment. Separate, identify and count all parts and metal hardware. Compare with all parts list to be sure all parts are present. If any part(s) are missing or damaged, please contact your local furniture dealer. For efficient and speedy service, please indicate the model number and code letter of part(s) needed.

*****Do not fully tighten screws until fully assembled*****

COMPONENT PARTS			
DESCRIPTION	PART NAME		Q'TY(PCS)
①	BACK CUSHION		2
②	CHAIR LEG WITH LABEL "L"		2
③	CHAIR LEG WITH LABEL "R"		2
④	BOXSEAT WITH LABEL "UP"		2
⑤	CUSHION SEAT		2

HARDWARE REQUIRED

Ⓐ		BOLT	M6 X 30MM	8	PCS
Ⓑ		BOLT	M6 X 40MM	16	PCS
Ⓒ		BOLT	M6 X 60MM	8	PCS
Ⓓ		LOCK WASHER	M6 X 12MM	32	PCS
Ⓔ		FLAT WASHER	M6 X 16MM	16	PCS
Ⓕ		ALLEN KEY	M4 X 100MM	1	PCS
Ⓖ		ADJUST SCREW		8	PCS

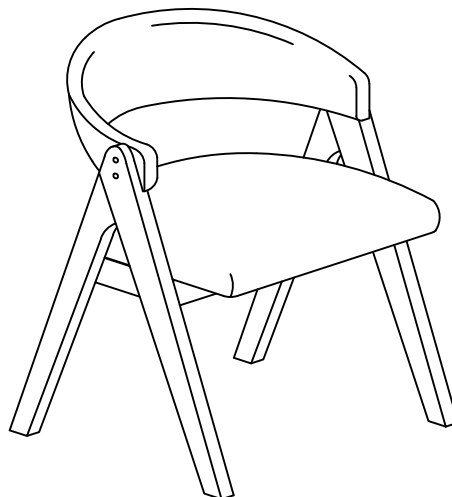

x 2

Attention

***Some number parts listed on the instruction sheet may not be in parts bag as they may already be assembled. Carefully check parts and packing materials prior to ordering replacements.

How to assemble:

STEP 1

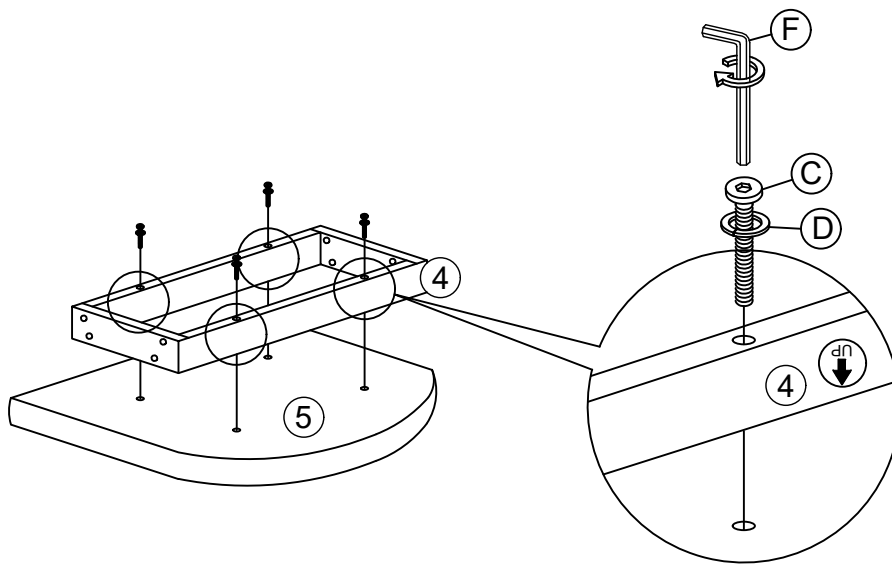

STEP 2

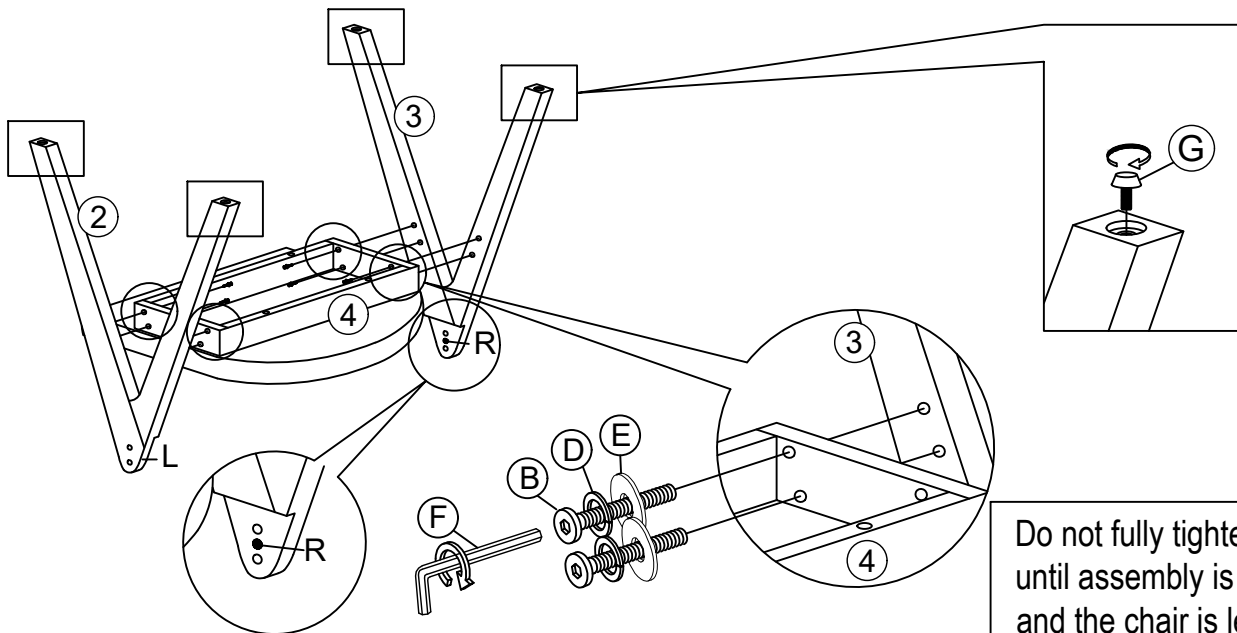

STEP 3

Remark :

