

OFFICE CHAIR

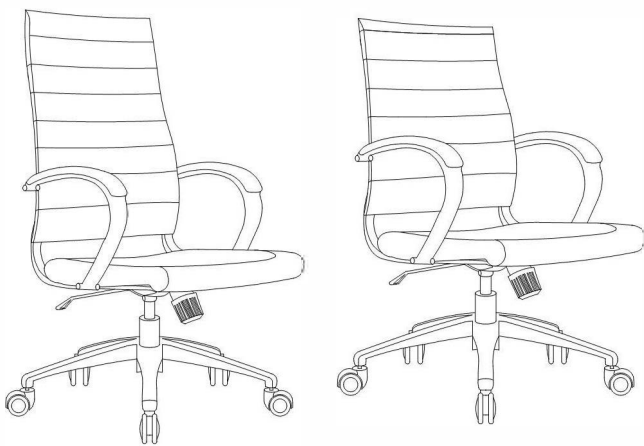



Thank you for purchasing our product.

Before you start, here are some helpful advice:

1. We suggest you spend a short time reading through this leaflet and then follow the simple step-by-step instructions.
2. Owing to the size and weight of the chair, we recommend that it is assembled by two adults, on a carpeted or padded area, in the room that it is intended for. Approximate assembly time: 30 minutes.
3. Please do not use any tools other than those provided or recommended in these instructions.
4. Please do not throw away any of the packaging or the instruction until you have checked all the components and hardware and the furniture is fully assembled. Please ensure that the packaging is disposed of in a safe and environmentally friendly way.
5. Assemble all components loosely until advised to tighten. Depending on use, it may be necessary to tighten the components from time to time, so please save the tools that have been provided.
6. Please keep all pieces out of reach of children.



Hardware:

- | | | | |
|----|---|--------------|----|
| A. |  | Bolt M8x48mm | x4 |
| B. |  | Crash Pad | x4 |
| C. |  | Cap Cover | x4 |
| D. |  | Allen Wrench | x1 |

Components:

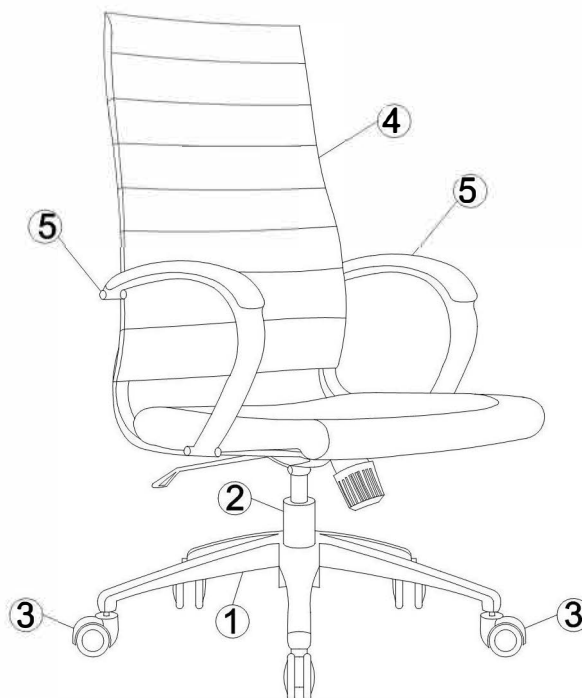

- | | | | | | |
|--------------------------------|----|--------------------|----|-----------|----|
| 1. Base | x1 | 2. Cylinder Column | x1 | 3. Castor | x5 |
| 4. Back with Control Mechanism | x1 | 5. Arm | x2 | | |

STEP 1:

1. Please put **Base (1)** on a carpeted or padded surface.
2. Insert 5 pieces of **Castors (3)** into the **Base (1)** as shown by hand.
3. Repeat the same steps for the remaining 4 pieces of **Castors (3)**.

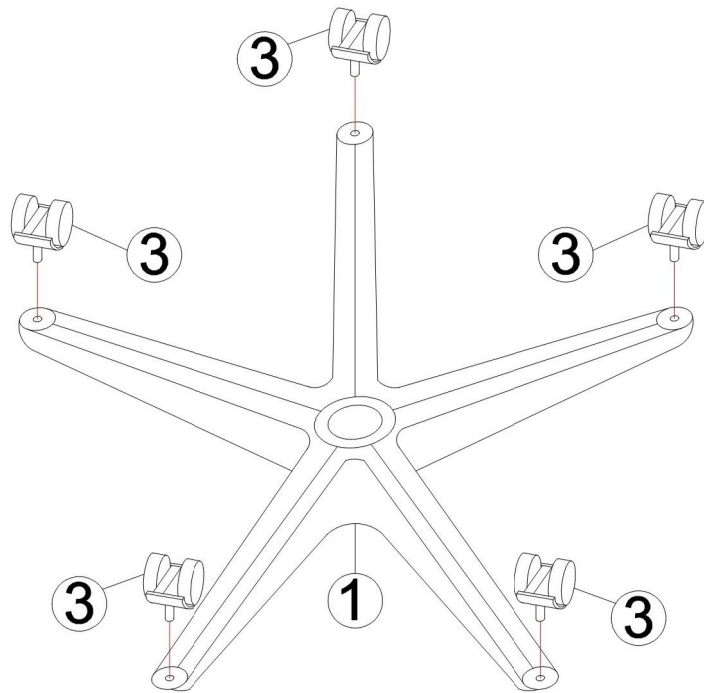

STEP 2:

1. Carefully turn over the assembled **Base (1)** from step 1.
2. Insert the **Cylinder Column (2)** as shown.

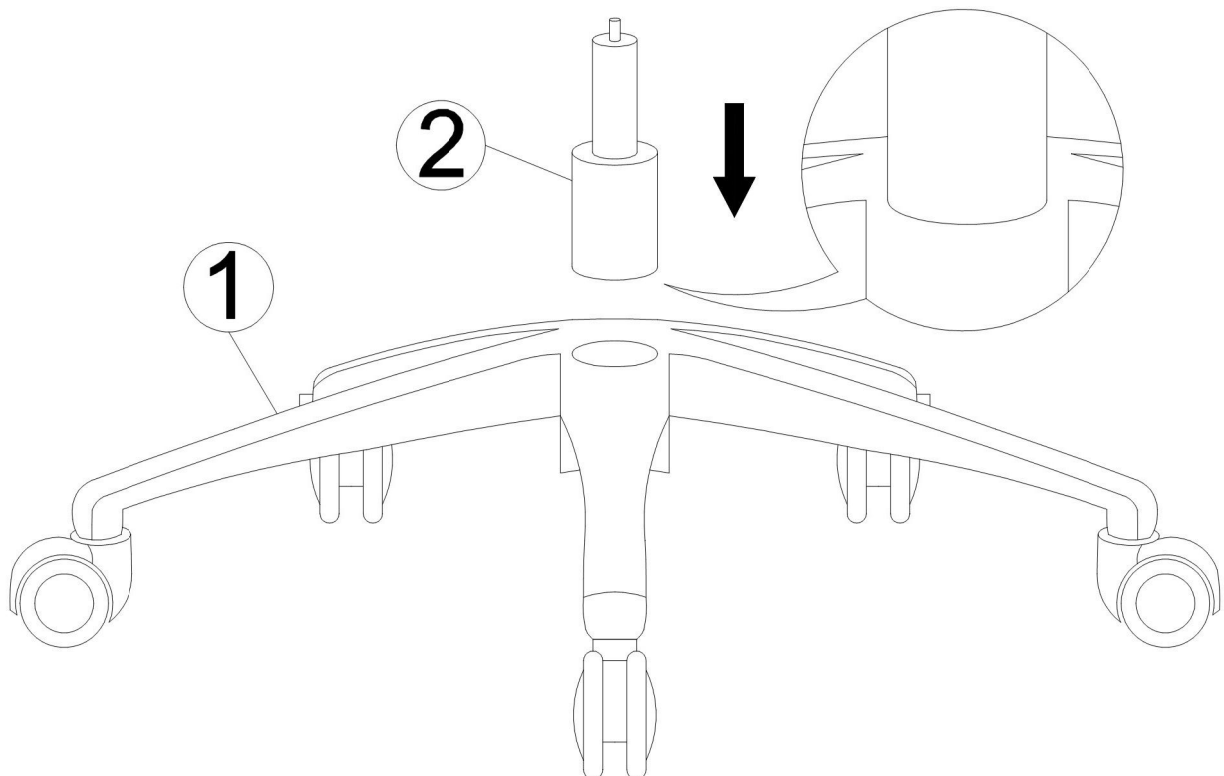

STEP 3:

1. Attach 1 piece of **Arm (5)** to the **Back with Control Mechanism (4)** by using 2 pieces of **Bolts (A)** with 2 pieces of **Crash Pads (B)** as shown, Tighten **Bolts (A)** by using **Allen Wrench (D)** and attach 2 pieces of **Cap Covers (C)** to the holes on **Arm (5)** by hand as shown.
2. Repeat the same steps for another **Arm (5)**.

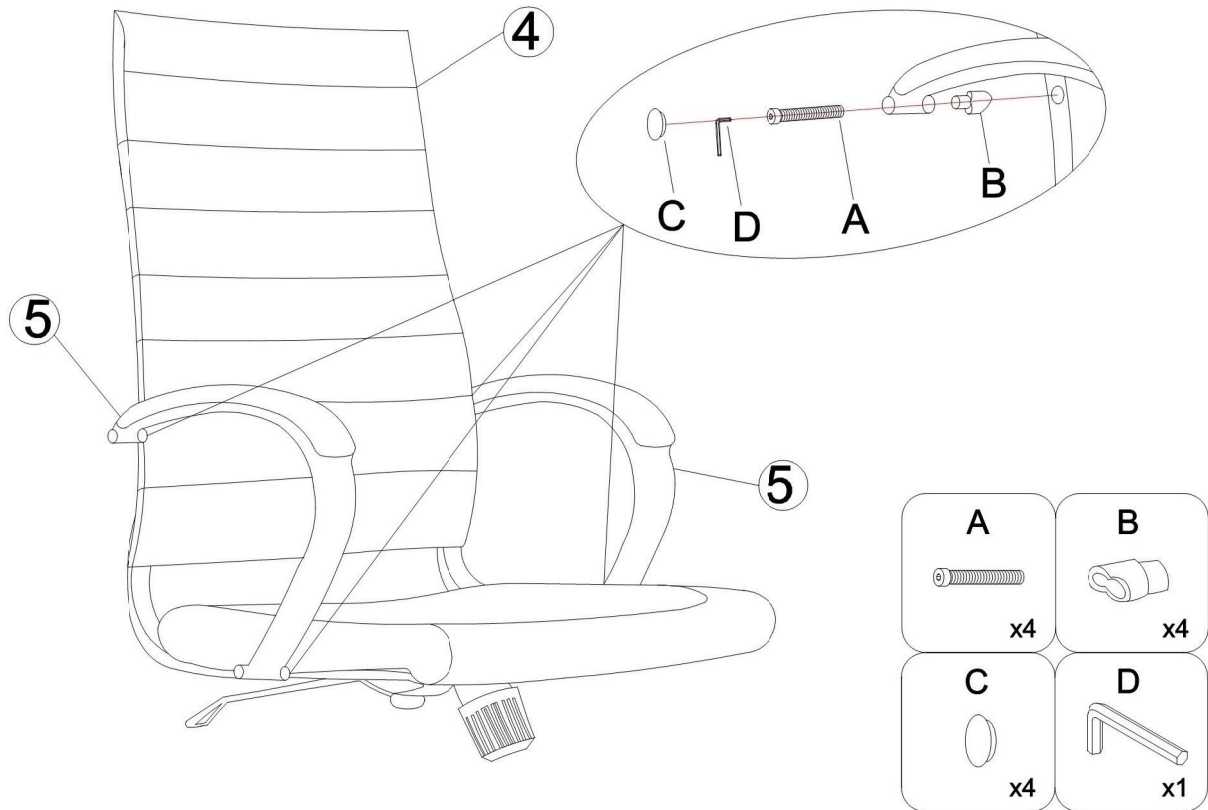
**Hardware & Tools Required****STEP 4:**

Insert **Back with Control Mechanism (4)** into the **Cylinder Column (2)** as shown

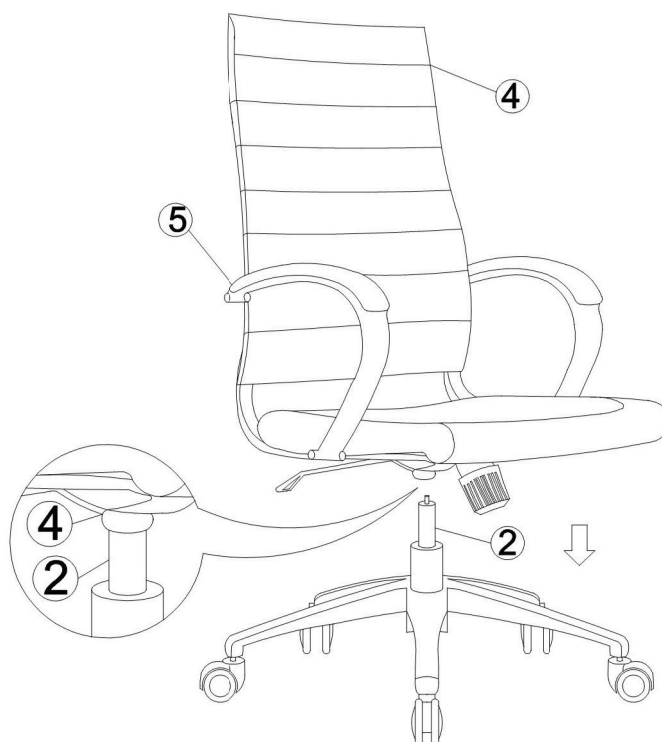

STEP 5:

Assembly is complete. Your office chair is ready to be used now!

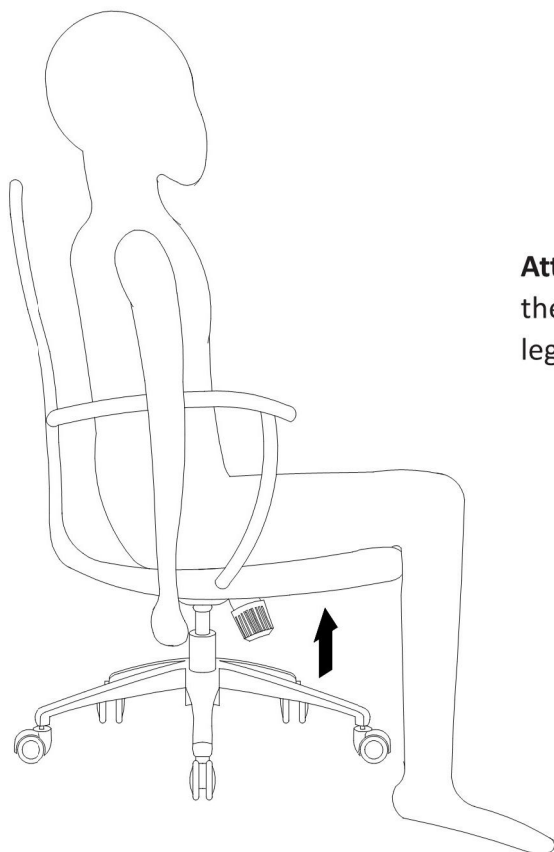

Attention: When you use the handle to adjust the height to be lower, please move away your legs from the foot ring at the same time.