

# OFFICE CHAIR

## ASSEMBLY INSTRUCTIONS



# ATTENTION







**Thanks for choosing our product.**

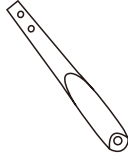
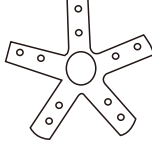
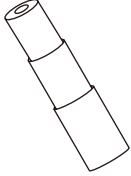
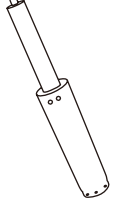

- 1. Please check the manual carefully and make sure you have received all the parts.**
- 2. If there is any missing part, please let us know the letter of the parts you need.**
- 3. If there is any damage part, please send clear photos to us, we will check and offer you best solution soon.**

# Assembly Instruction

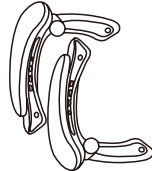
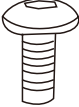
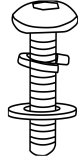
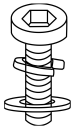
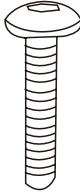
## Parts List

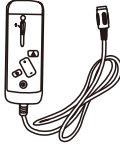
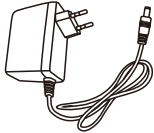
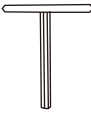
<b>A</b> 	<b>B</b> 	<b>C</b> 	<b>D</b> 	<b>E</b> 	<b>G</b> 
5 pcs	5 pcs	1 pc	1 pc	1 pc	1 pc
<b>H</b> 	<b>I</b> 	<b>J</b> 	<b>K</b>  M6*15mm	<b>L</b>  M6*30mm	<b>M</b>  M8*25mm
1 pc	1 pc	2 pcs	10 pcs	4 pcs	3 pcs
<b>N</b>  M8*35mm	<b>O</b> 	<b>P</b> 	<b>Q</b> 	<b>R</b> 	
4 pcs	4 pcs	1 pc	1 pc	1 pc	

Please note: Please check carefully if there are any missing parts before installation. If there are any missing parts, please place all the parts and take pictures then tell us the missing part number. We will reply you as soon as possible.

# Assembly Instruction

## Chair Assembly

### Step 1

A\*5

K\*10

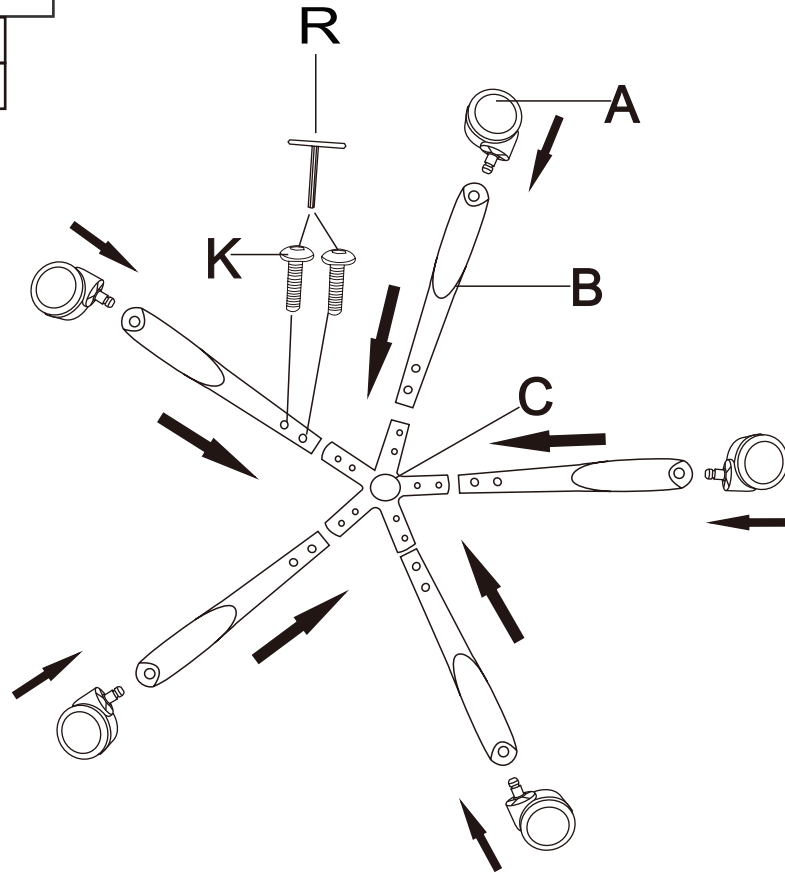

First, we need to prepare the connector (C), 5\* metal feet (B), 5\* universal wheels (A), 10\*15mm screws (K) and a wrench (R). Then, according to the figure, insert the 5\* metal feet into the connector, align the screw holes, install the screws and tighten them. Finally, a universal wheel is installed on the tail of each metal foot.

# WARRANTY

So glad you have completed the assembly and can enjoy it.

If you are satisfied with our products, thank you for showing it to your around.

Our products come with a 12-month warranty, please register within 30 days by send " your name + order ID" to

# AFTER-SALE POLICY

### For return reason:

Wrong purchase, bought by mistake, no longer needed, doesn't meet expectation, a size smaller than expectation, customer need to cover the return shipping fee.

### For cancel order:

Customer needs to pay for shipping fee and carrier handle fee if the item has been shipped out.

For change address: customer needs to pay for extra shipping fee and carrier handle fee if the item has been shipped out.

### Customer Service:

Any problem with the product or shipping issue, please feel free to contact us, we will try our best to serve and help.

# Assembly Instruction

## Chair Assembly

### Step 8

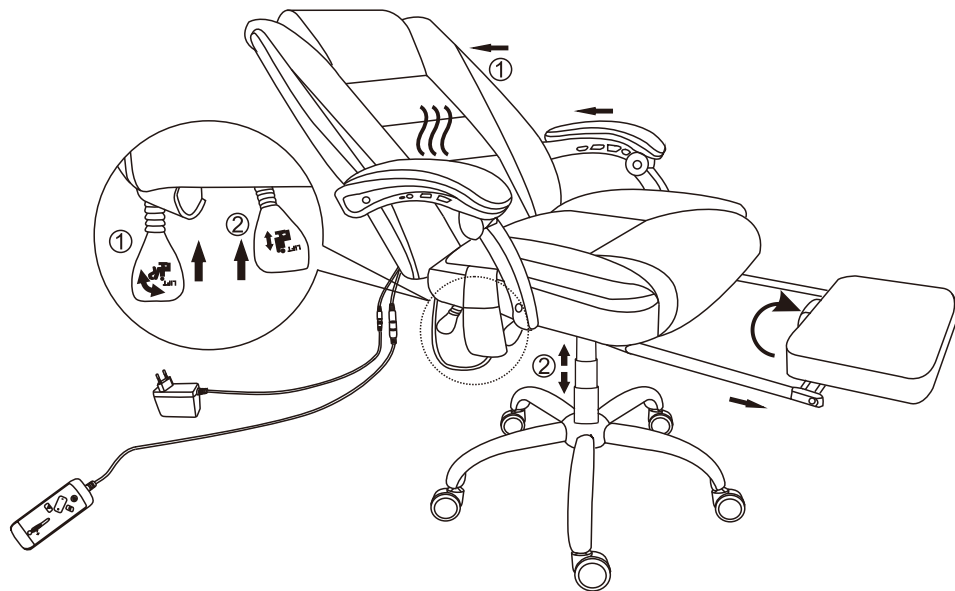

# Assembly Instruction

## Chair Assembly

### Step 2

D\*1

E\*1

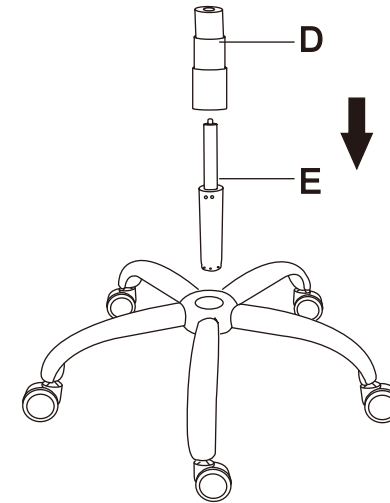

### Step 3

L\*4

I\*1

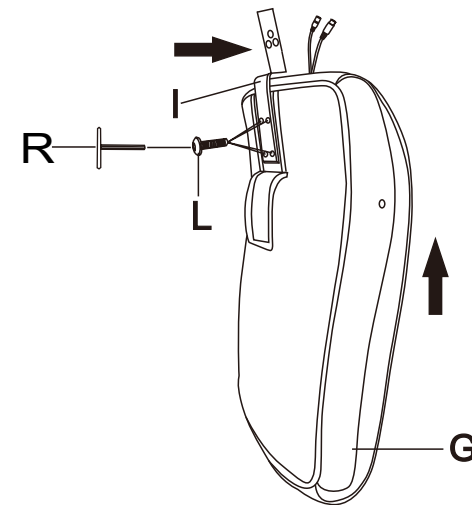

As shown in the figure, insert the connecting piece 'I' into the interface at the bottom of the backrest and fix it with 4 screws numbered 'L'.

# Assembly Instruction

## Chair Assembly

**Step 4**

M\*3

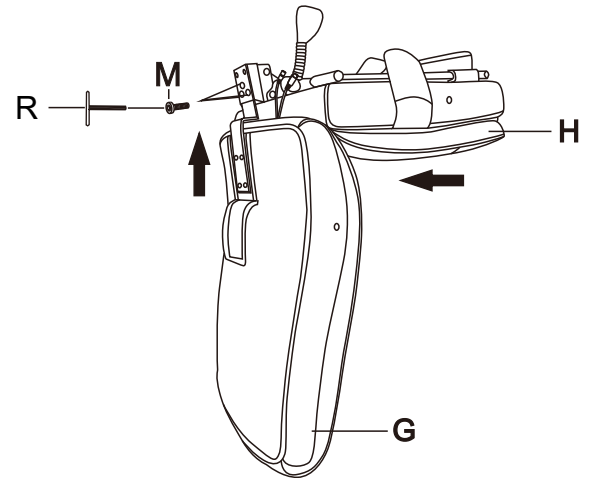

As shown in the figure, insert the other end of the connecting piece 'I' into the interface behind the cushion and fix it with 3 screws numbered 'M'.

**Step 5**

J\*2

N\*4

O\*4

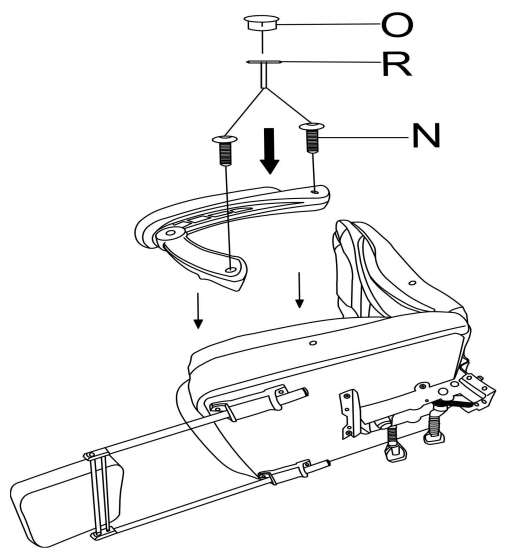

# Assembly Instruction

## Chair Assembly

**Step 6**

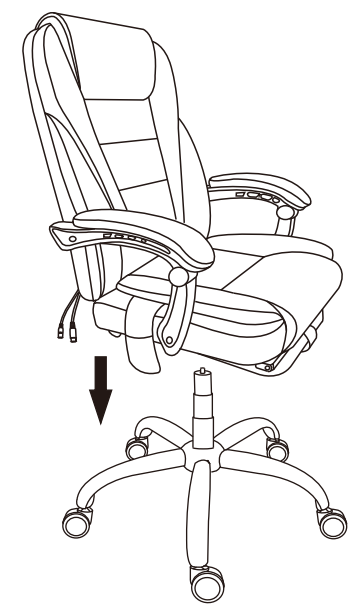

**Step 7**

P\*1

Q\*1

