

NEC510 series

Corded stick vacuum cleaner; household type

Owner's Guide

Thank you for purchasing your new Eureka vacuum!

Important instructions

For easy assembly, please take a few moments to read this owner's guide. If you have questions about your new vacuum, please contact our customer service HELPLINE at 1-800-282-2886. We're here to help!



Eureka stands by our
Clean Promise seal.
Learn more at
www.eureka.com/cleanpromise

www.eureka.com

eureka

Where to find important vacuum information

Keep this information

Write the model, type and serial number here:

Date of purchase (keep your receipt) _____

Model number and type _____

Serial number _____

Find these numbers on a label on the hand vacuum.
Refer to these numbers when ordering parts and accessories, or if service is needed.



This Owner's Guide provides important instructions to prolong the life of your Eureka vacuum cleaner

Registration: To register your product visit www.eureka.com and click on the 'Register Your Product' link in the top right corner.

Inspection: Carefully unpack and inspect your new Eureka vacuum cleaner for shipping damage. Each unit is tested and thoroughly inspected before shipping. For instructions regarding any shipping damage, call the Eureka Customer Service **HELPLINE** at **1-800-282-2886** immediately.

Contents

Important safeguards.3
What comes in the carton4
How to identify parts of your vacuum cleaner5
Easy assembly, and How to use storage base6
How to use your vacuum cleaner7
How to use hand vacuum and accessory tools	7-8
How to maintain your vacuum cleaner9
How to maintain dust cup, filters and brushroll9
The Eureka limited warranty10
Thermal cut-off and problem solving11
How to order replacement parts12

 Follow caution information wherever you see this symbol.

IMPORTANT SAFEGUARDS

When using an electrical appliance, basic precautions should always be followed, including the following:

READ ALL INSTRUCTIONS BEFORE USING THIS VACUUM CLEANER

Failure to follow the warnings and instructions may result in electric shock, fire and/or serious injury.

WARNING

- Prevent unintentional starting. Ensure the switch is in the off-position before picking up or carrying the appliance. Carrying the appliance with your finger on the switch or energizing appliance that has the switch on invites accidents.
- Do not touch nozzle when the vacuum cleaner is on. Danger.
- Do not put any object into openings. Do not use with any openings blocked; keep free of dust, lint, hair and anything that may reduce air flow.
- Do not use outdoors or on wet surfaces.
- Do not operate the vacuum cleaner if it has been damaged in any way. If vacuum cleaner is not working as it should, has been dropped, damaged, left outdoors, or dropped into water, call the Eureka Customer Service **HELPLINE** at **1-800-282-2886**.
- Do not allow to be used as a toy. Close attention is necessary when used by or near children.
- Use only as described in this manual. Use only manufacturer's recommended attachments.
- Do not unplug by pulling on cord. To unplug, grasp the plug, not the cord.
- This product is functioning at temperature range within 40°F - 104°F.
- Have servicing performed by a qualified repair person using only identical replacement parts. This will ensure that the safety of the product is maintained.
- Do not modify or attempt to repair the appliance except as indicated in the instructions for use and care.
- This vacuum cleaner creates suction. Keep hair, loose clothing, fingers, and all parts of body away from openings and moving parts.
- Do not pick up anything that is burning or smoking, such as cigarettes, matches, or hot ashes.
- Do not use without filters in place.
- Use extra care when cleaning stairs.
- Do not use to pick up flammable or combustible liquids, such as gasoline, or use in areas where they may be present.
- Store vacuum cleaner and charger indoors in a cool, dry area. To avoid electric shock and/or cleaner damage, do not expose to weather elements.
- Keep your work area well lit. Unplug electrical appliances before vacuuming them.
- Do not incinerate this appliance even if it is severely damaged. Contact local waste facility before discarding in trash.
- **WARNING:** This product can expose you to chemicals including Di(2-ethylhexyl)phthalate (DEHP), which is known to the State of California to cause cancer and to cause birth defects or other reproductive harm. For more information go to www.P65Warnings.ca.gov.

SAVE THESE INSTRUCTIONS

What comes in the carton

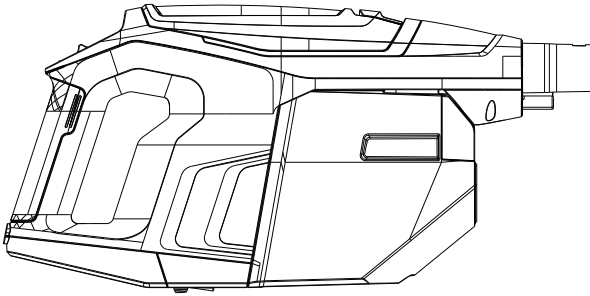

Hand vacuum

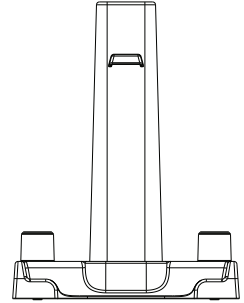

Storage base
(comes as two separate pieces
must be assembled)



Important
safeguards

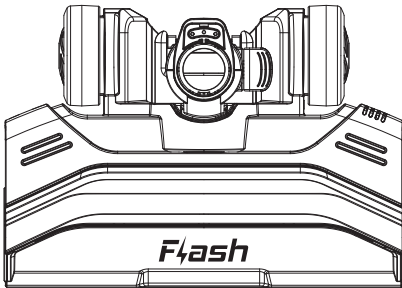

Motorized floor nozzle

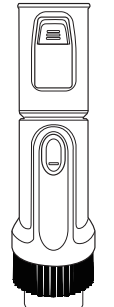

2-in-1
upholstery tool



Crevice tool

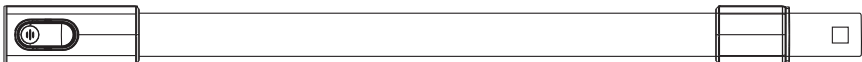

Wand

How to identify parts of your vacuum cleaner

Corded vacuum cleaner

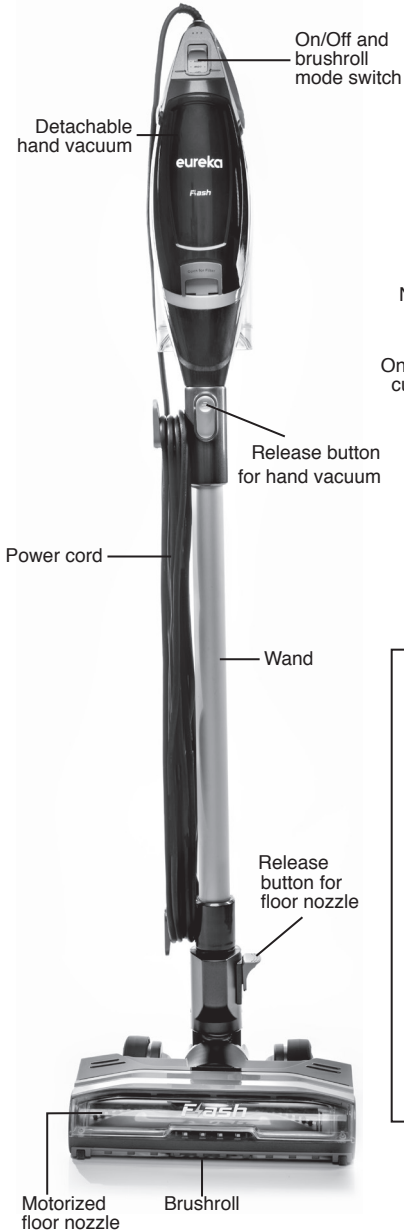

Hand vacuum

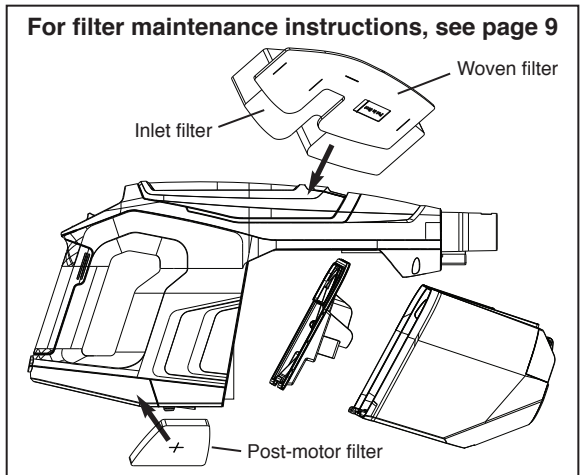
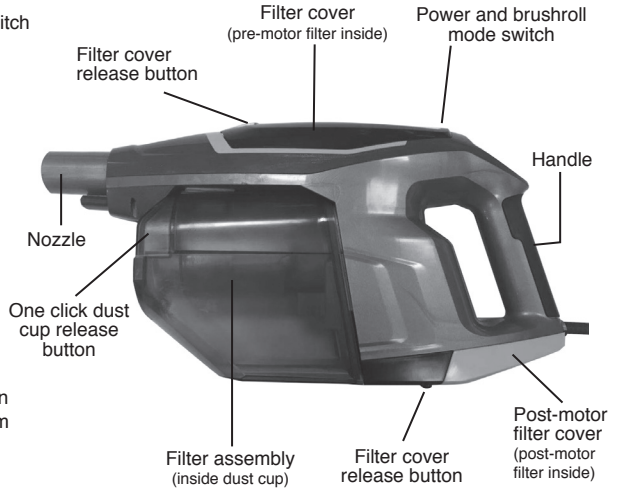

Easy assembly

1. Slide wand onto hand vacuum until it clicks (Fig. 1).
2. Push wand into motorized floor nozzle until it clicks (Fig. 2).

How to use storage base

1. Insert storage base shaft into slot on base until it clicks into place. Ensure side of shaft that says Floor Nozzle goes in the same side as wheel well.
2. Detach hand vacuum from wand
3. Keep wand attached to floor nozzle and place in the wheel well rest on storage base
4. On back of hand vacuum, slightly below the vent, locate the notch
5. On upright portion of storage base locate the hook
6. Align notch on hand vacuum so it rests on storage base hook
7. Wrap power cord either around the cord wrap hooks on the wand or around the hand vacuum.
8. Tools can be stored on the two side mounts

Note: When lifting unit on storage base always make sure hooks are properly engaged with both the wand and the hand vacuum

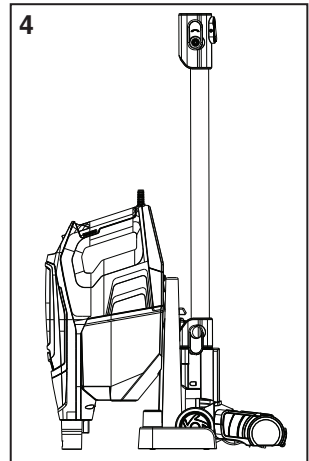
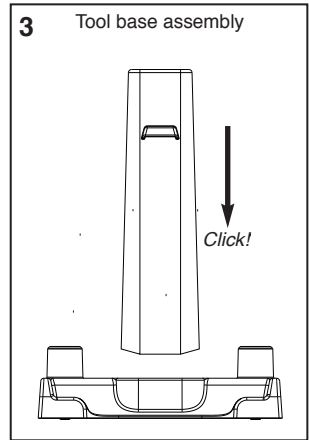
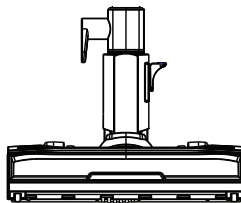
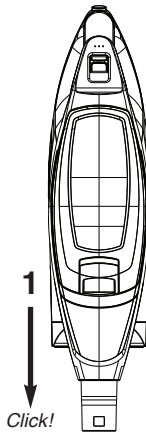

How to use cleaner for cleaning floors

1. Move power switch on handle to the first position for bare floor cleaning and second position to engage brushroll for carpet cleaning (Fig 1)
2. Using motorized floor nozzle, glide back and forth on area to be cleaned. Avoid oversized or sharp items (such as screws) with cleaner.
3. Twist wrist to engage swivel function.
4. When done, switch to off position

1 Power button/
speed controls

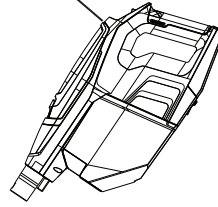

2

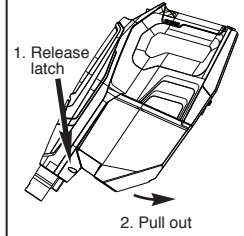

Empty dust cup after every use

1. Click the dust cup release button, located on the bottom of the dust cup to detach it from the unit pull dust cup out. (Fig. 2).
2. Use handle on top of dust cup to remove lid, empty dust cup and replace lid (Fig. 3)
3. To place dust cup back, align hooks on dust cup to slots on body and press up until it clicks into place (Fig. 4)

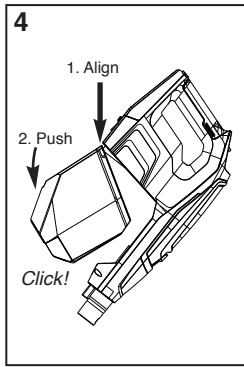
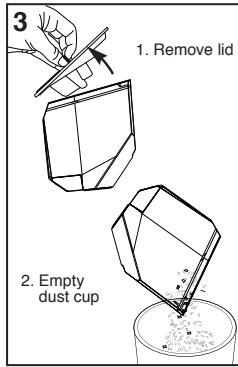

How to use hand vacuum and accessories

CAUTION

Moving parts! Always turn off hand vacuum before attaching accessories.

The hand vacuum can be used with or without tools.

- To use without tools, press release button and remove wand. Collect debris directly with hand vacuum nozzle.
- To use tools with wand, press release button to remove motorized floor nozzle. Slide tool onto end of wand until it clicks (Fig. 4).
- To use tools with hand vacuum only, press release button to remove wand. Slide tool onto hand vacuum until it clicks.

Crevice tool: Cleans hard-to-reach areas such as corners, baseboard edges, dryer vents, chairs and sofas.

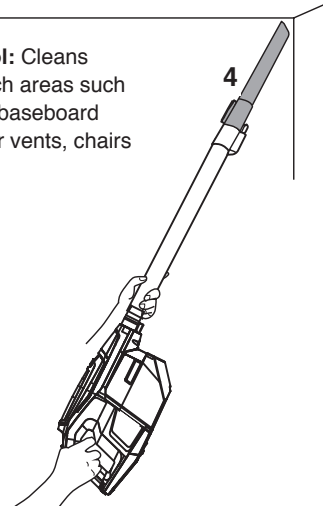

(continued on p. 8)

How to use hand vacuum and accessories

(continued)

Use with or without wand.

- **2-in-1 upholstery tool:** Use brush to vacuum blinds, vents or upholstered surfaces. Use felt portion to clean delicate surfaces. To switch between felt and brush portions, press thumb release and slide brush up or down.

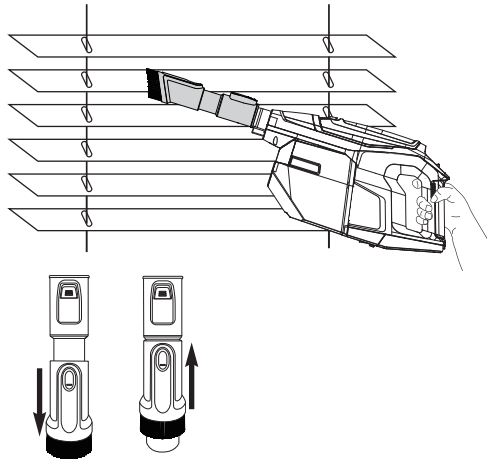

How to use hand vacuum and motorized floor nozzle

Ideal for cleaning stairs.

- Press release button to remove wand from hand vacuum. Attach motorized floor nozzle directly to hand vacuum until it clicks.
- Use power switch button to go between settings to do barefloor cleaning or engage brushroll for carpets.

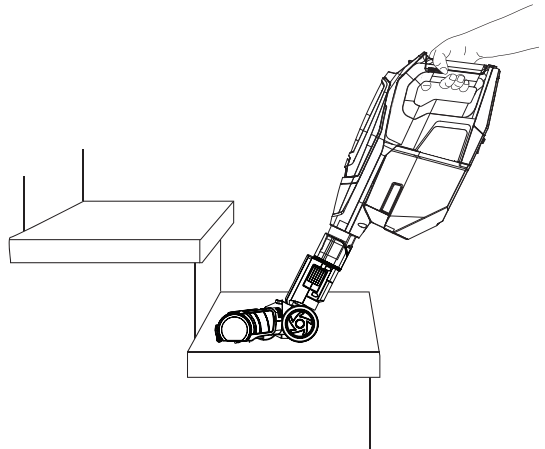

How to maintain your vacuum cleaner

CAUTION

Never operate vacuum cleaner without all filters, filter screen and dust cup in proper position.

WARNING: Moving parts!

Dust cup – Empty after each use

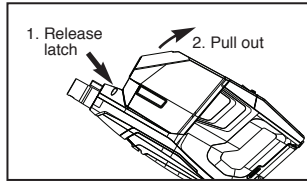

Click the dust cup release button, located on the bottom of the dust cup to detach it from the unit, and pull dust cup out.

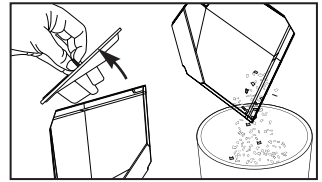

Use handle on top of dust cup to remove lid, empty dust cup and replace lid.

Washable pre and post-motor filters - clean regularly

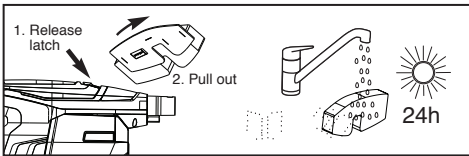

1. On front of hand vac, locate the latch and pull to remove plate and take out pre-motor filter. Just below the cord on the back of the hand vac, locate the latch to remove the vented plate and take out post-motor filter.
2. Lift out pre-motor filter and shake off dust frequently. Rinse filter and dry THOROUGHLY.
3. Reattach filters.
4. Click corresponding plates back into place.

How to maintain brushroll

To avoid unnecessary service calls, periodically check brushroll for debris. If brushroll gets clogged it will automatically shut off. Turn vacuum off and unplug before attempting to remove clog.

Washable brushroll – clean frequently

CAUTION

Make sure vacuum cleaner is turned off and not plugged into a power source.

WARNING: Do not attempt to remove belt. Call the Eureka Customer Service HELPLINE at 1-800-282-2886.

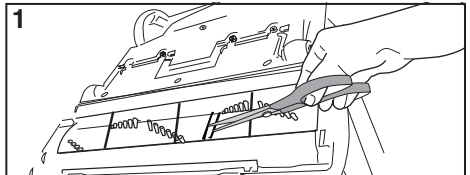

Step on floor nozzle to lower handle. Turn vacuum face down on floor. Use scissors to clip heavy threads or strings.

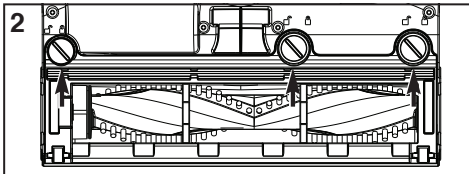

If debris cannot be removed easily, remove retainer to access brushroll. Using flathead screwdriver or coin turn screws to the 'unlock' position. Remove the brushroll and clear any tangled hair and remaining debris.

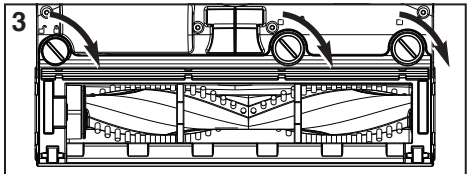

To reassemble:

1. Align one end of brushroll with floor nozzle gear.
2. Press other end into slot.
3. Place retainer back in place and put in screws and turn to 'lock' position.

The Eureka three year limited warranty

Midea America Corp. ("Eureka"), subject to the terms and conditions herein, warrants this vacuum cleaner to be free from defects in material and workmanship for a term of three years from the date of original purchase when used in accordance with the Eureka operating and maintenance instructions and under normal household usage. This warranty is granted only to the original purchaser and members of immediate household, and is applicable only to original purchases from Eureka authorized resellers.

What Eureka will do:

Eureka will, at its option, repair or replace a defective vacuum or vacuum part that is covered by this warranty. Repairs may be performed using new or refurbished parts that meet or exceed Eureka specifications for new parts. If Eureka elects to replace the vacuum, the replacement may be a reconditioned unit. Depending on availability of products, Eureka reserves the right to provide you with a replacement product that is the same or similar, or substitute equivalent of the original product. As a matter of warranty policy, Eureka will not refund the consumer's purchase price.

This warranty does not cover:

- Normal wear and tear of the vacuum and vacuum parts that require replacement under normal use such as disposable dust bags, filters, drive belts, light bulbs, brush-roll, bristles, impellers and cleaning.
- Damages or malfunctions resulting from: improper or unreasonable use or maintenance, abuse, negligence, failure to follow instructions contained in any written materials that accompany the product, deterioration by reason of excess moisture, corrosive atmosphere, lightning, power surges, connections to improper voltage supply, unauthorized alteration, or other external causes such as extremes in temperature or humidity, modifications, scratches or discoloration, accidents, misuse, or acts of God. This warranty also does not cover damage resulting from repair or attempted repair by anyone other than Eureka or an authorized Eureka Warranty Station. This warranty is not applicable to any product that has been altered or on which the serial number has been defaced, modified or removed. Altering, erasing, or forging any proof-of-purchase documents voids any applicable product warranty.

Obtaining warranty service:

To obtain warranty service you must contact the Eureka Service Team, toll free, at 1-800-282-2886 or email customerserviceusa@midea.com, to discuss the warranty claim and procedures to be followed. All warranty claims must include submission of proof-of-purchase documentation. For additional information, you may also visit www.eureka.com.

Shipping charges:

You will be responsible for any initial shipping and insurance charges if the defective product(s) must be shipped for warranty service or warranty evaluation; however, Eureka or a Eureka Authorized Warranty Station will pay the return shipping charges if repairs are covered by the warranty. When returning parts for repair, you must include the model, type and serial number located on the rating plate. If any product submitted for warranty service is found to be ineligible, an estimate of repair cost will be furnished and the repair performed only if requested by the owner and upon receipt of payment or acceptable arrangements for payment.

Further limitations and exclusions:

Any warranty that may be implied in connection with your purchase or use of the vacuum, including any warranty of Merchantability or any warranty of Fitness For A Particular Purpose is limited to the duration of this limited warranty. Some states do not allow limitations on how long an implied warranty lasts, so the above limitations may not apply to you.

Your relief for the breach of this warranty is limited to the relief expressly provided above. In no event shall the manufacturer be liable for any consequential or incidental damages you may incur in connection with your purchase or use of the vacuum. Some states do not allow the exclusion or limitation of incidental or consequential damages, so the above limitation or exclusion may not apply to you. This warranty gives you specific legal rights. You may also have other rights, which may vary by state.

Midea America Corp. • 5 Sylvan Way • Parsippany, NJ 07054 • USA

Eureka Customer Service HELPLINE 1-800-282-2886

Problem solving









Make sure vacuum cleaner is off and charging plug is unplugged.

NOTICE : Thermal cut-off

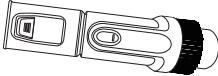
This vacuum cleaner has a special thermostat that protects the vacuum cleaner in case of motor overheating. **If the vacuum suddenly shuts off**, proceed as follows: 1) Check the vacuum for a possible source of overheating such as a full dust cup, blocked wand or clogged filters. If these conditions are found, fix them and wait at least 30 minutes before attempting to use the vacuum. 2) After the **30 minute** period, press the power button. If the vacuum still does not work, call the Eureka Customer Service **HELPLINE** at **1-800-282-2886**.

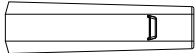
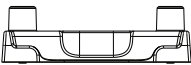
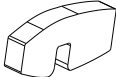
Problem	Solution
Motor will not start	<ul style="list-style-type: none">• Push cord securely into electrical outlet, try another outlet or check circuit breaker.• See detailed “thermal cut-off” instructions above.
Not enough suction power	<ul style="list-style-type: none">• Empty dust cup and clean or change filters. See page 9 for maintenance instructions.• Remove clogs that restrict the airflow.
Brushroll will not turn	<ul style="list-style-type: none">• Check brushroll for debris. See page 9 for maintenance instructions.

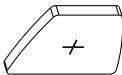
Image	Part name	Part # (fits models)
	Crevice tool	Z0101 (all)
	Floor nozzle	N0201
	Wand	N0202
	2-in-1 upholstery tool	Z0201 (all)
	Brush roll	Z0208
	Base shaft	N0203
	Lower base	N0204
	Inlet filter	N0205
	Woven filter	N0206
	Outlet filter	N0207