

ASSEMBLY INSTRUCTIONS

TOOLS Required

- Phillips Head Screwdriver (Standard Size) – Not Included
- Allen Wrench - Included

Recommended (Not Required):

- Electric Screwdriver or Power Driver
CAUTION: DO NOT OVERTIGHTEN. If using an Electric Screwdriver or Power Driver, please make sure that the tool is set to a very low torque to prevent damage to the product.
- Socket Wrench Set







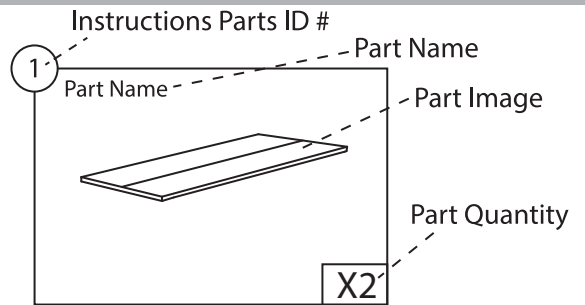



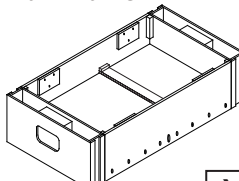

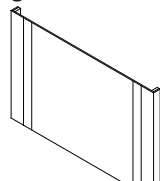
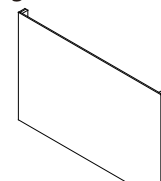
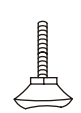

How to use the PARTS IDENTIFIER

Before you begin assembly, please make sure that you have all the parts listed and in the correct quantities. This will ensure the quickest and most organized assembly.

Be sure to work on the assembly on a soft non-marring surface such as carpet or the inside of the corrugate box top to prevent causing damage to the table surface during assembly. If using the box top, remove all staples from the box first.



PARTS IDENTIFIER

<p>1 Main Frame</p>  <p>X1</p>	<p>2 Leg End Panel</p>  <p>X4</p>	<p>3 Leg Side Panel-A</p>  <p>X2</p>	<p>4 Leg Side Panel-B</p>  <p>X2</p>
<p>5 Leg Leveler</p>  <p>X4</p>	<p>6 Entry Cup - Outside</p>  <p>X2</p>	<p>7 Rod - 2 Player</p>  <p>X2</p>	<p>8 Rod - 3 Player</p>  <p>X4</p>
<p>9 Rod - 5 Player</p>  <p>X2</p>	<p>10 Rod - Bumper</p>  <p>X16</p>	<p>11 Rod - Washer - Molded</p>  <p>X16</p>	<p>12 Player - Head - Black</p>  <p>X13</p>
<p>13 Player - Head - Ivory</p>  <p>X13</p>	<p>14 Player - Front - Black</p>  <p>X13</p>	<p>15 Player - Front - Ivory</p>  <p>X13</p>	<p>16 Player - Back - Black</p>  <p>X13</p>

PARTS IDENTIFIER

17 Player - Back - Ivory

X13

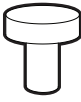
18 Player - Chest Post

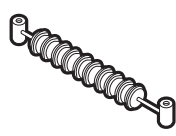
X26

19 Player - Head Weight

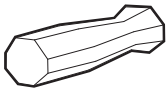
X26

20 Slide Scorer

X2

21 Rod - End Cap

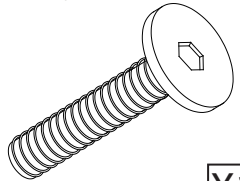
X8

22 Handle

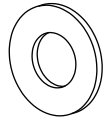
X8

HARDWARE

60 Long Bolt

X12

61 Washer

X12

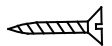
62 Short Bolt

X24

63 Flat Washer

X24

64 Short Screw

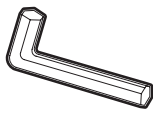
X4

65 Long Screw

X4

66 Allen Key

X1

ACCESSORIES

80

Foosball



X2

START

BEFORE BUILDING - Please inspect and layout all your PARTS

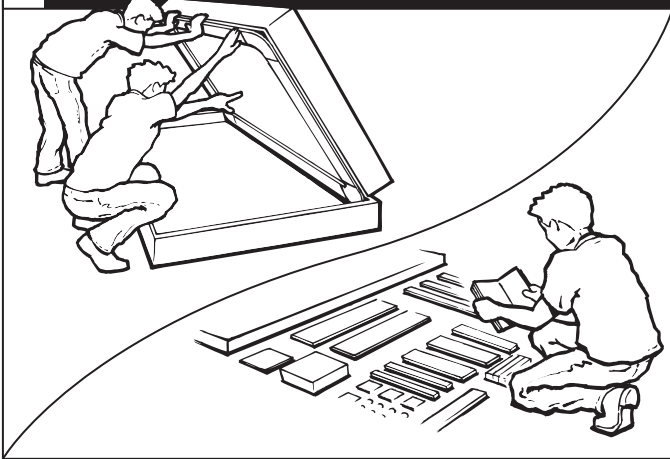

All parts are listed in the Parts Identifier and Accessories. Your Cabinet (Table Game Playfield) is **NOT REPLACEABLE**. Any damage that exists to your Cabinet is not repairable. If your Cabinet is damaged, the entire game must be returned to the original place of purchase for an exchange.

Please review the Parts Identifier and make sure that you have all parts before beginning assembly.

STEP 1

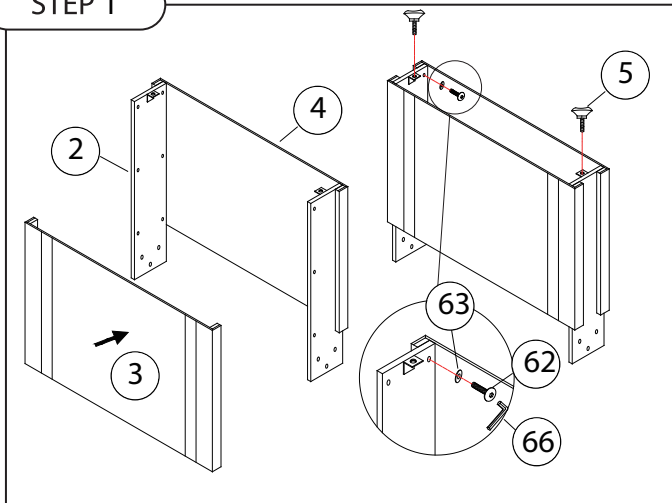

COMPONENTS

COMPONENTS	QTY.
② Leg End Panel	x4
③ Leg Side Panel-A	x2
④ Leg Side Panel-B	x2

HARDWARE

HARDWARE	QTY.
⑤ Leg Leveler	x4
⑥② Short Bolt	x24
⑥③ Flat Washer	x24
⑥⑥ Allen Key	x1

NOTE:

Repeat for both Legs.

DO NOT overtighten Bolts.

STEP 2

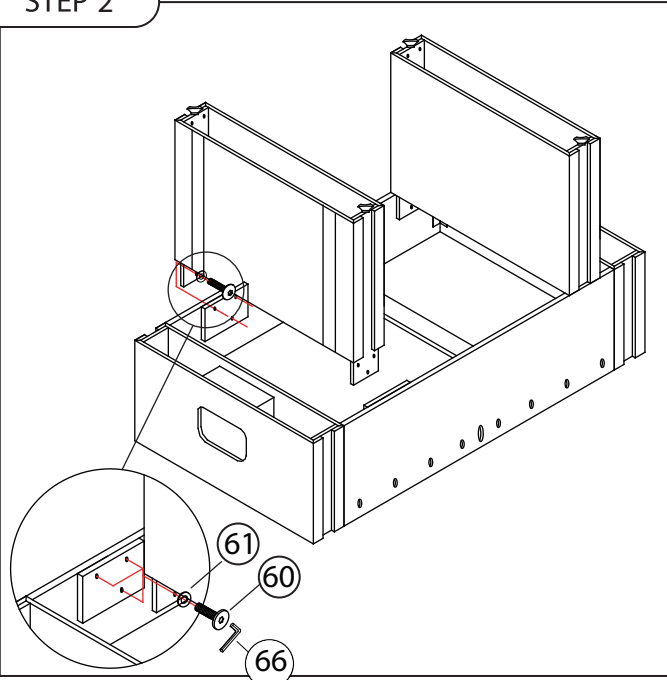

COMPONENTS	QTY.
HARDWARE	
60 Long Bolt	x12
61 Washer	x12
66 Allen Key	x1

NOTE:
DO NOT overtighten Bolts and Screws.

Repeat for both sides.

STEP 3

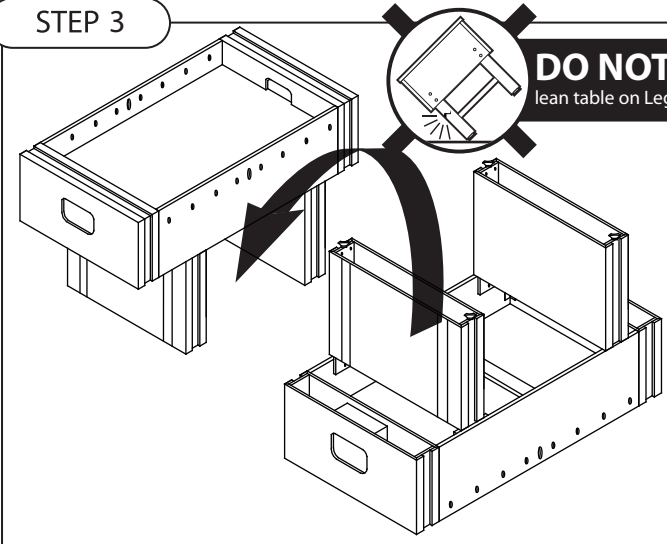

COMPONENTS	QTY.
HARDWARE	

NOTE:
Using at least 2 STRONG ADULTS, pick up & flip the Table over. Then rest the Table on all 4 Legs.

STEP 4

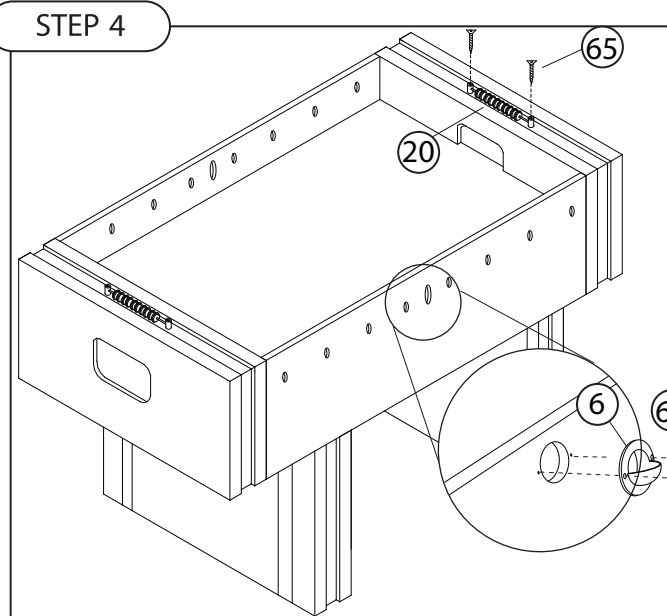

COMPONENTS	QTY.
6 Entry Cup - Outside	x2
20 Slide Scorer	x2
HARDWARE	
64 Short Screw	x4
65 Long Screw	x4

NOTE:
Repeat for both sides.
DO NOT overtighten Screws.

STEP 5

NOTE: Hole at the end of Rod designates handle location. See Arrow Location Below

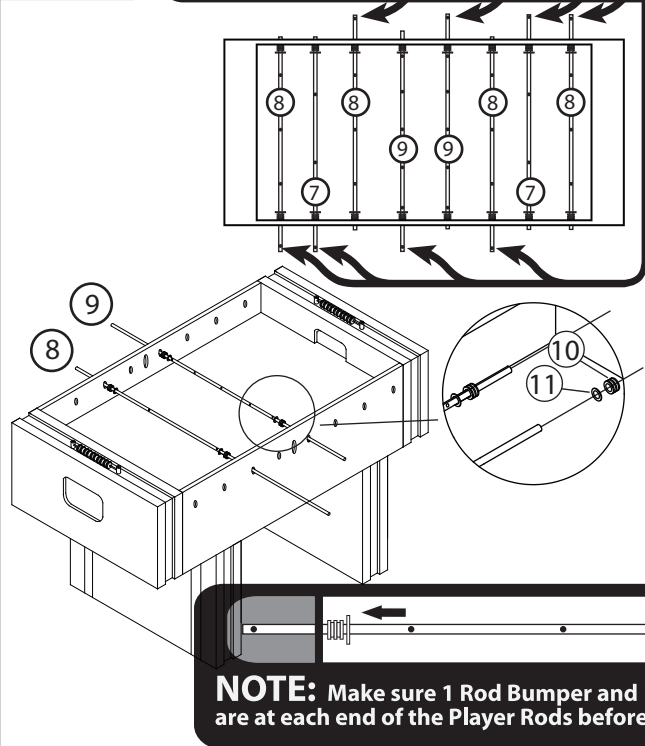

COMPONENTS

QTY.

- ⑦ Rod - 2 Player x2
- ⑧ Rod - 3 Player x4
- ⑨ Rod - 5 Player x2
- ⑩ Rod - Bumper x16
- ⑪ Rod - Washer - Molded x16

NOTE:

Repeat for all Player Rods.

STEP 6

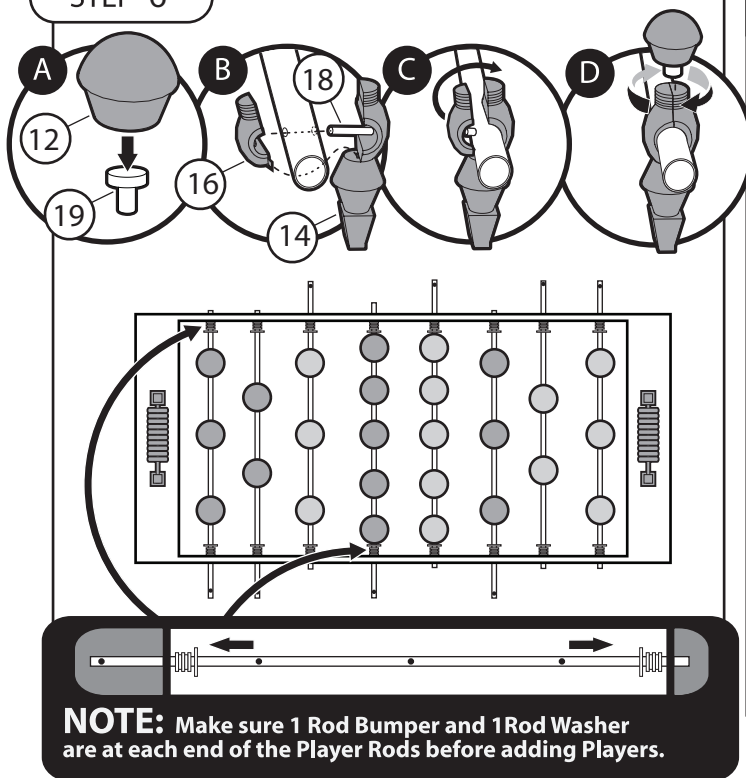

COMPONENTS

QTY.

- ⑫ Player - Head - Black x13
- ⑬ Player - Head - Ivory x13
- ⑭ Player-Front - Black x13
- ⑮ Player-Front - Ivory x13
- ⑯ Player - Back - Black x13
- ⑰ Player - Back - Ivory x13
- ⑱ Player - Chest Post x26
- ⑲ Player - Head Weight x26

NOTE:

Repeat for all Players.

STEP 7

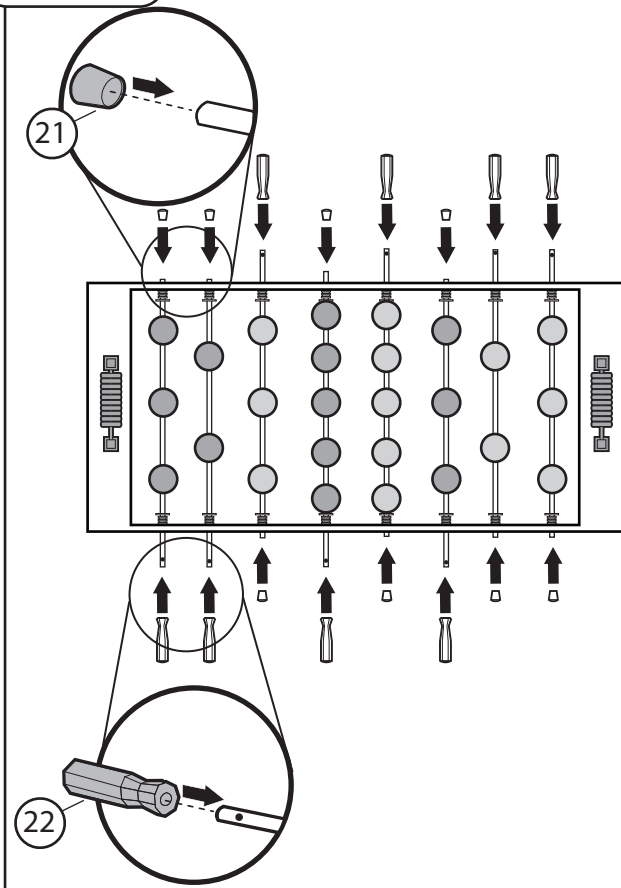

COMPONENTS

QTY.

21 Rod - End Cap

x8

22 Handle

x8

NOTE:

HARDWARE

QTY.