

ASSEMBLY INSTRUCTIONS

- Thank you for purchasing and using our sofa products.
- There are two combinations of sofas. Please refer to the list of corresponding parts and assembly methods according to the actual purchase.

ATTENTION:

- The product is away from heat and fire sources.
- Keep the product away from sharp objects.
- Do not use strong detergents or polishes such as detergents, solvents, abrasives, spray bags or leather cleaners to clean products.
- Use colorless gentle soap to mix warm water (mix 1:10 percent of soap and water) or professional cleaning products to clean the sofa.
- Do not place furniture in direct sunlight, the product may fade over time.
- Some parts of the product have been compressed. Please open the compression bag after receiving the product, make the parts fluffy, and it will slowly return to their original state within 72 hours.

Combination A

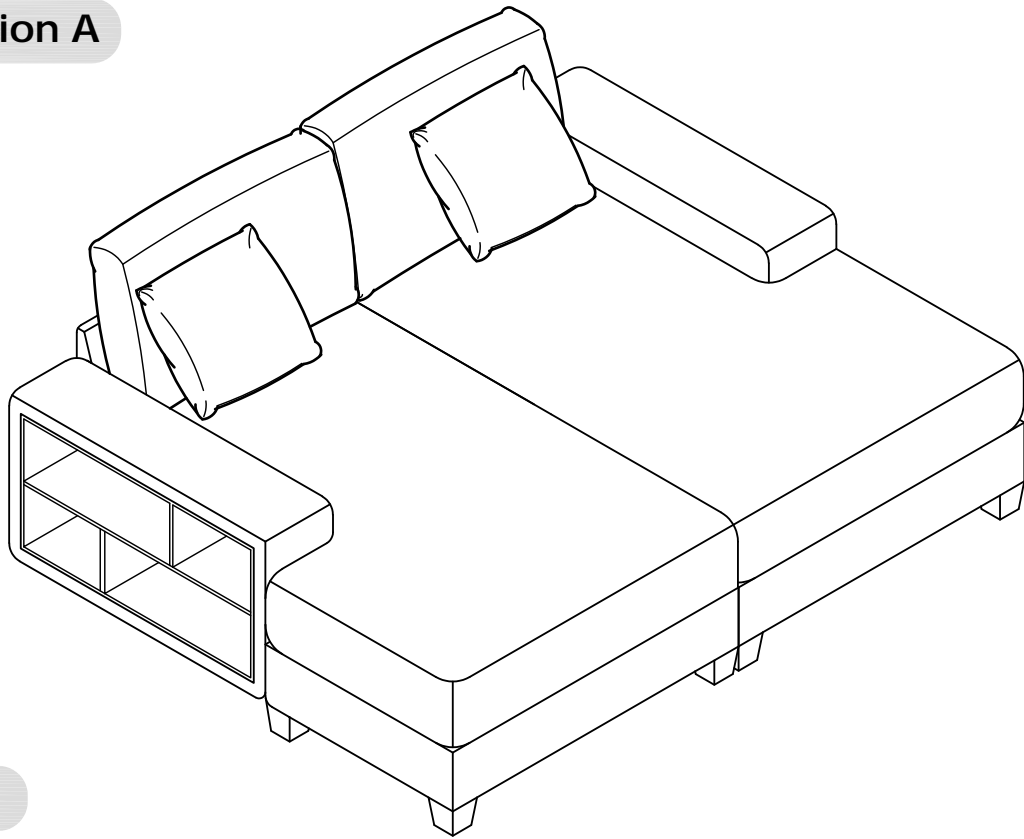

Parts list

(A1) Left armrest

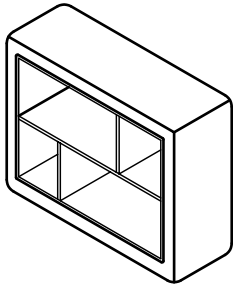

1pcs

(A2) Right armrest

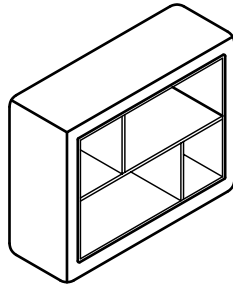

1pcs

(B1) Back shelf

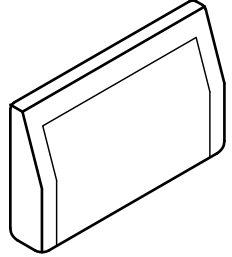

2pcs

(B2) Left armrest single seat frame

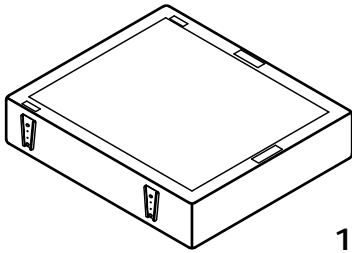

1pcs

(B3) Right armrest single seat frame

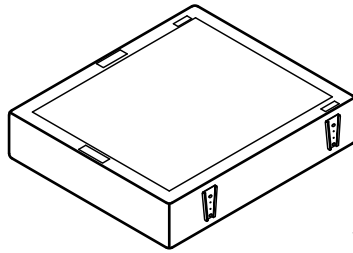

1pcs

(B4) Footstool cradle

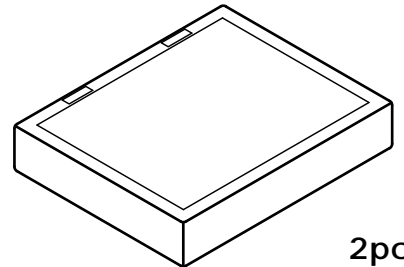

2pcs

(C1) Cushion

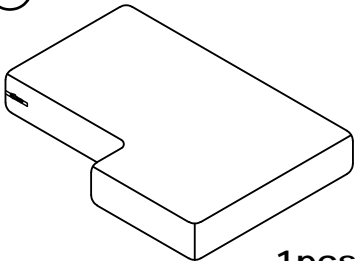

1pcs

(C2) Cushion

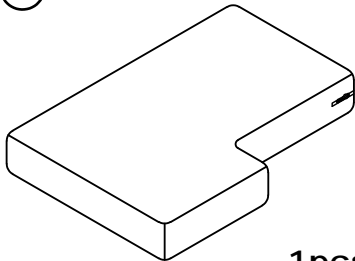

1pcs

(C3) Backpack

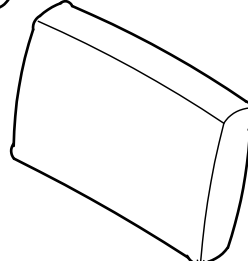

2pcs

(C4) Throw pillow

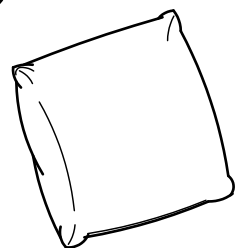

2pcs

(E1) Plastic feet

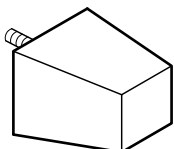

16pcs

(E2) Inserts

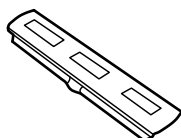

4pcs

(E3) Non-slip gasket

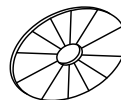

16pcs

(E4) Metal hooks

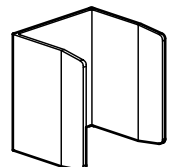

3pcs

Combination B

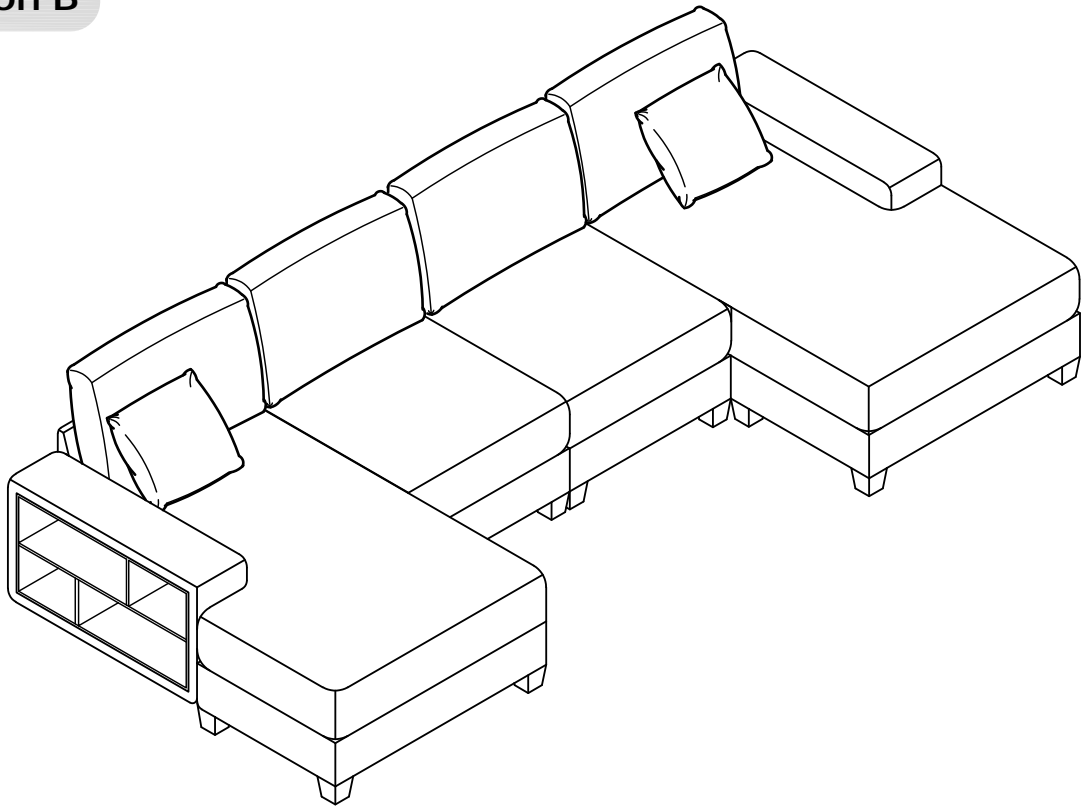

Parts list

This is a new product component added on the basis of combination A.

(B1) Back shelf

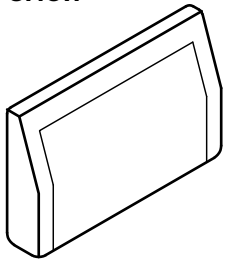

2pcs

(B5) Single seating frame

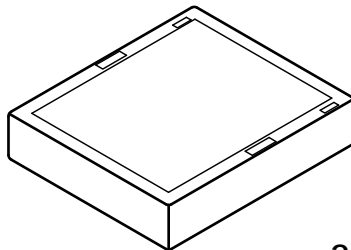

2pcs

(C3) Backpack

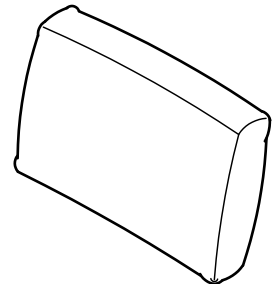

2pcs

(C5) Cushion

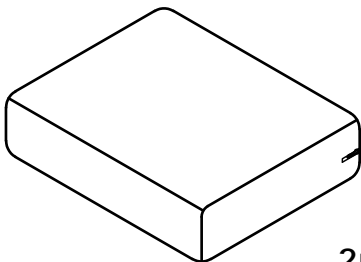

2pcs

(E1) Plastic feet

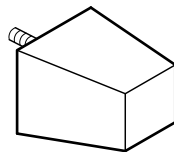

8pcs

(E2) Inserts

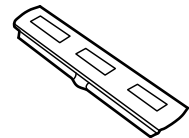

4pcs

(E3) Non-slip gasket

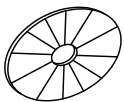

8pcs

(E4) Metal hooks

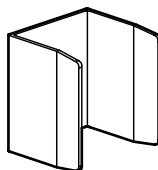

2pcs

Combination A packing list

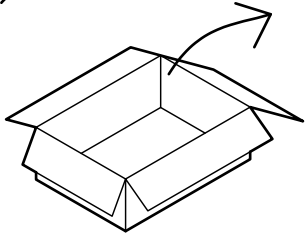

Handrail

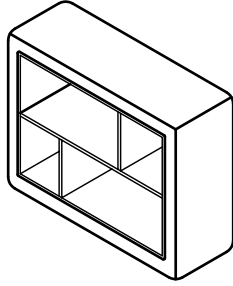

A1*1Pcs

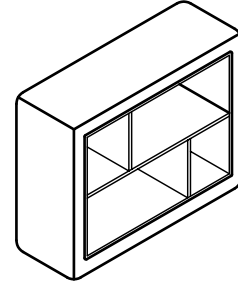

A2*1Pcs

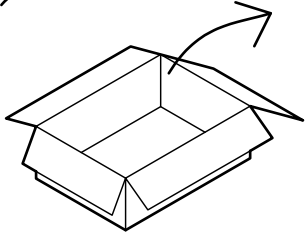

Handrail for one person

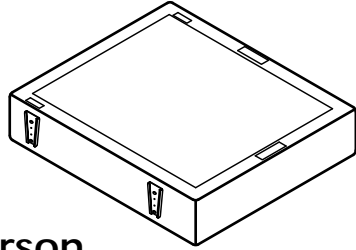

B2*1Pcs

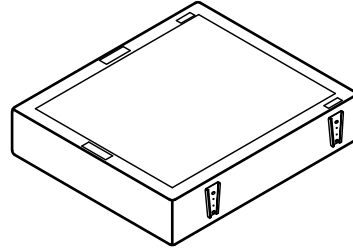

B3*1Pcs

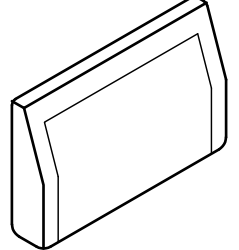

B1*2Pcs

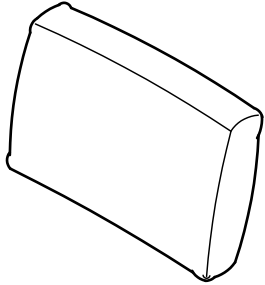

C3*2Pcs

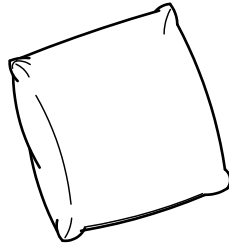

C4*2Pcs

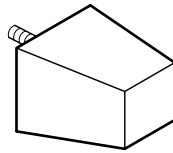

E1*8Pcs

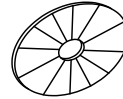

E3*8Pcs

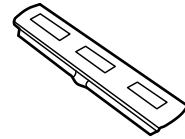

E2*4Pcs

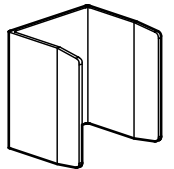

E4*3Pcs

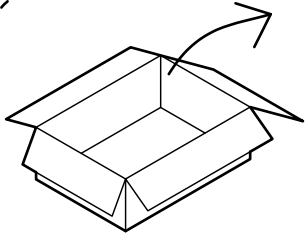

Footstool

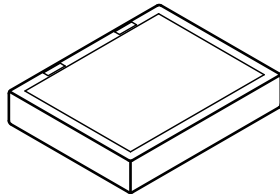

B4*2Pcs

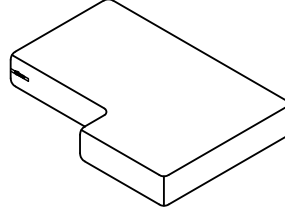

C1*1Pcs

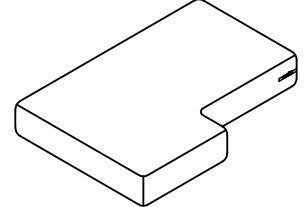

C2*1Pcs

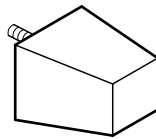

E1*8Pcs

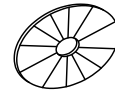

E3*8Pcs

Combination B packing list

This is a new product packaging on the basis of combination A

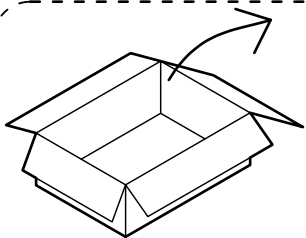

Single seat

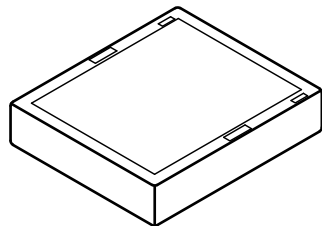

B5*2Pcs

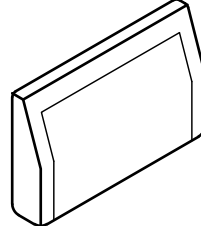

B1*2Pcs

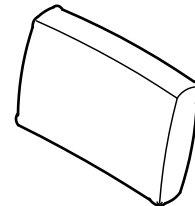

C3*2Pcs

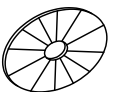

E3*8Pcs

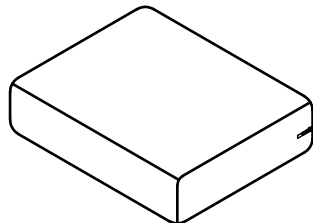

C5*2Pcs

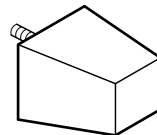

E1*8Pcs

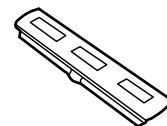



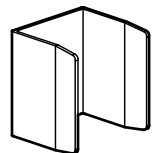

E2*4Pcs



E4*2Pcs

Combination A assembly steps



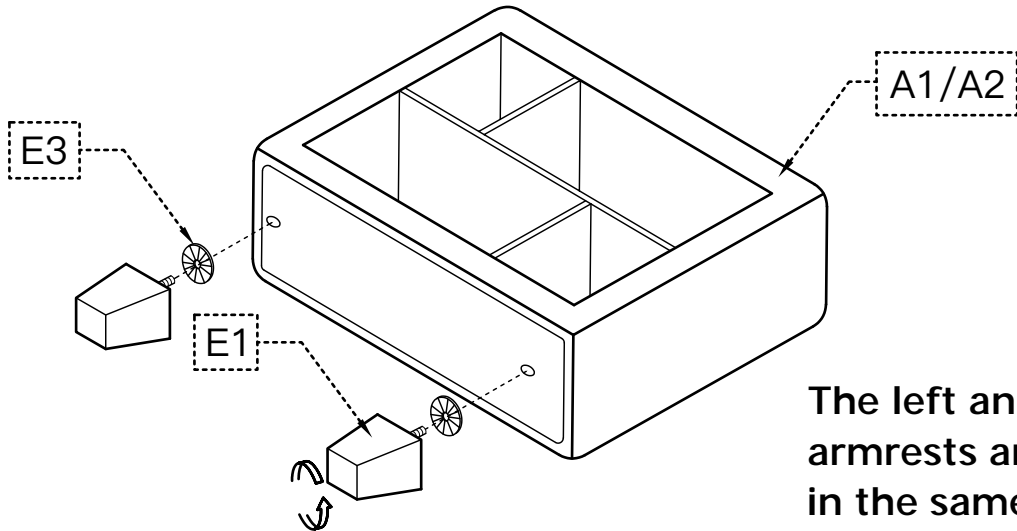

STEP 1

A1		x1
A2		x1
E1		x4
E3		x4



The left and right armrests are installed in the same way.

STEP 2

B2		x1
B3		x1
E1		x4
E3		x4

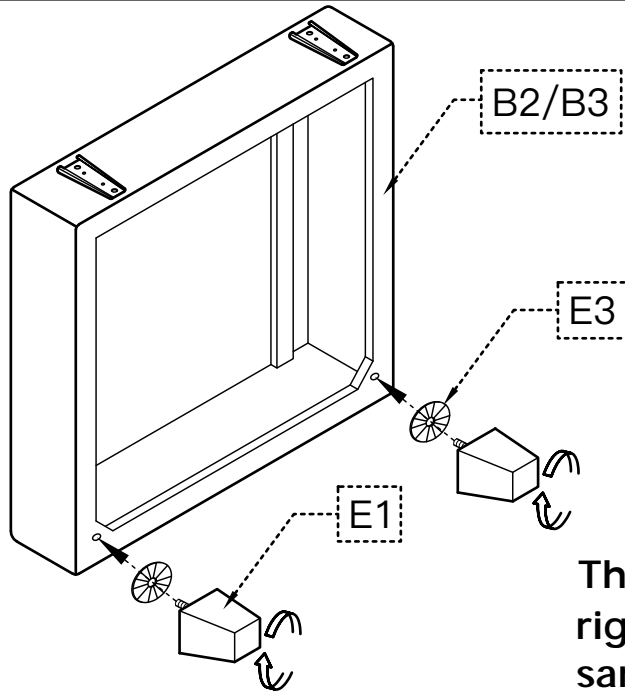

The single seats of the left and right armrests are installed in the same way.

STEP 3

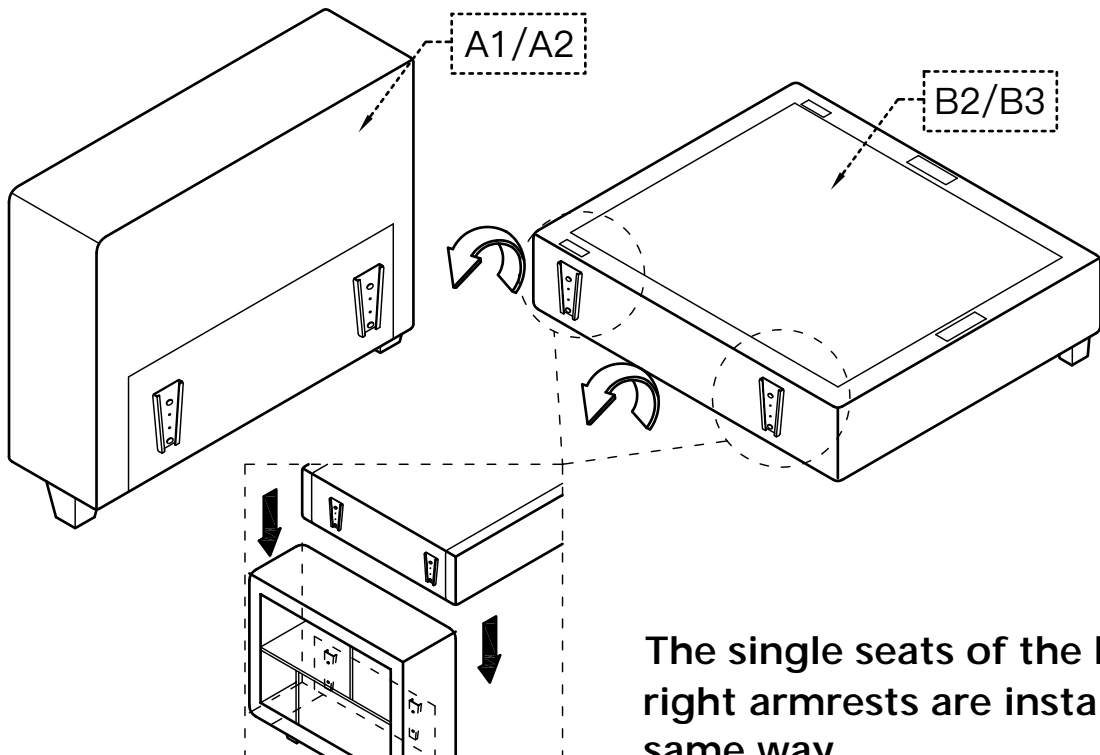

The single seats of the left and right armrests are installed in the same way.

Combination A assembly steps

STEP 4

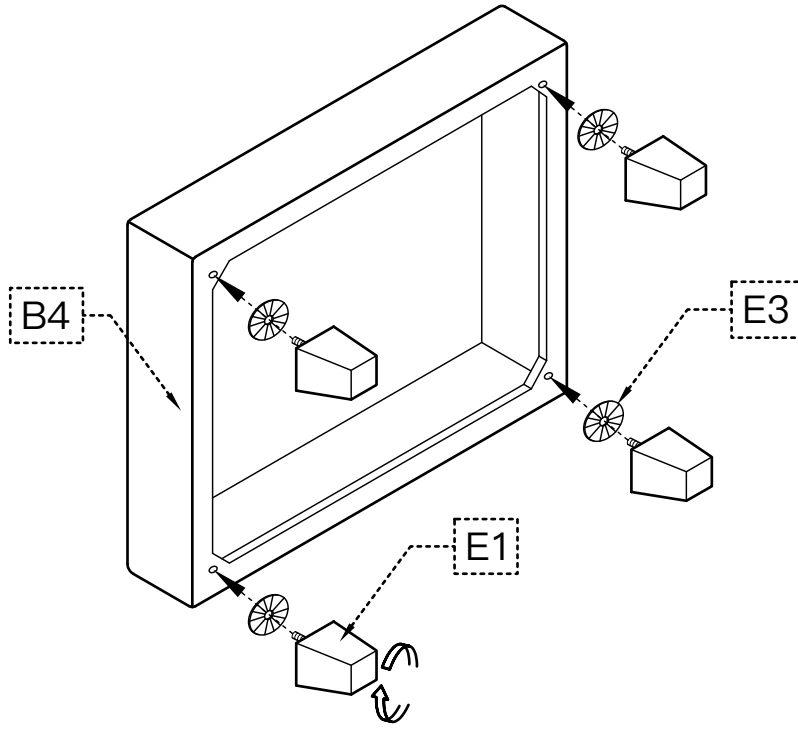

B4		x2
E1		x8
E3		x8

STEP 5

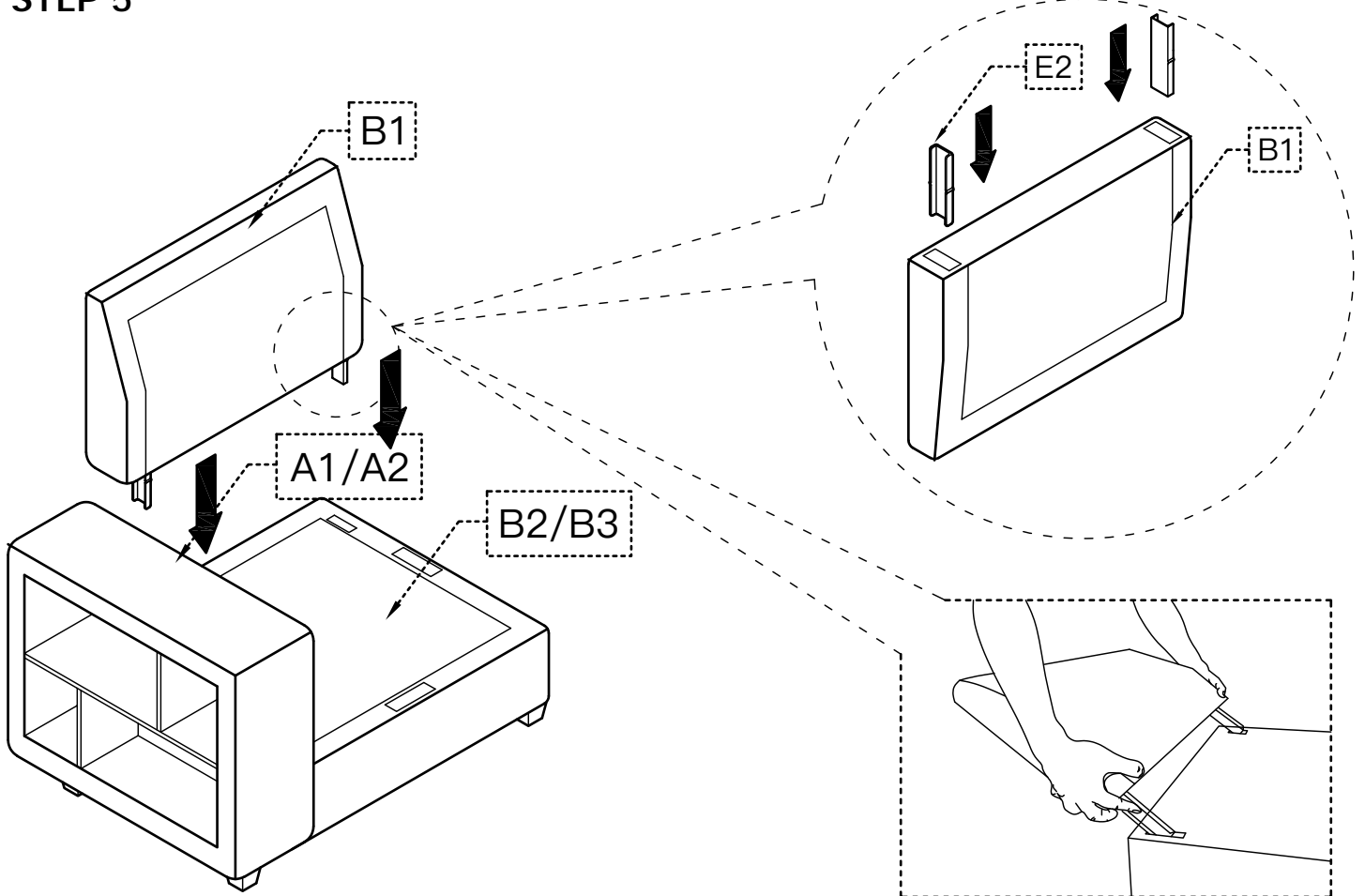

B1		x2
E2		x4

Install the connector under the backrest, and then insert it at the corresponding position at an angle of 45°. The left and right armrests are installed in the same way.

Combination A assembly steps

STEP 6

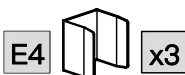
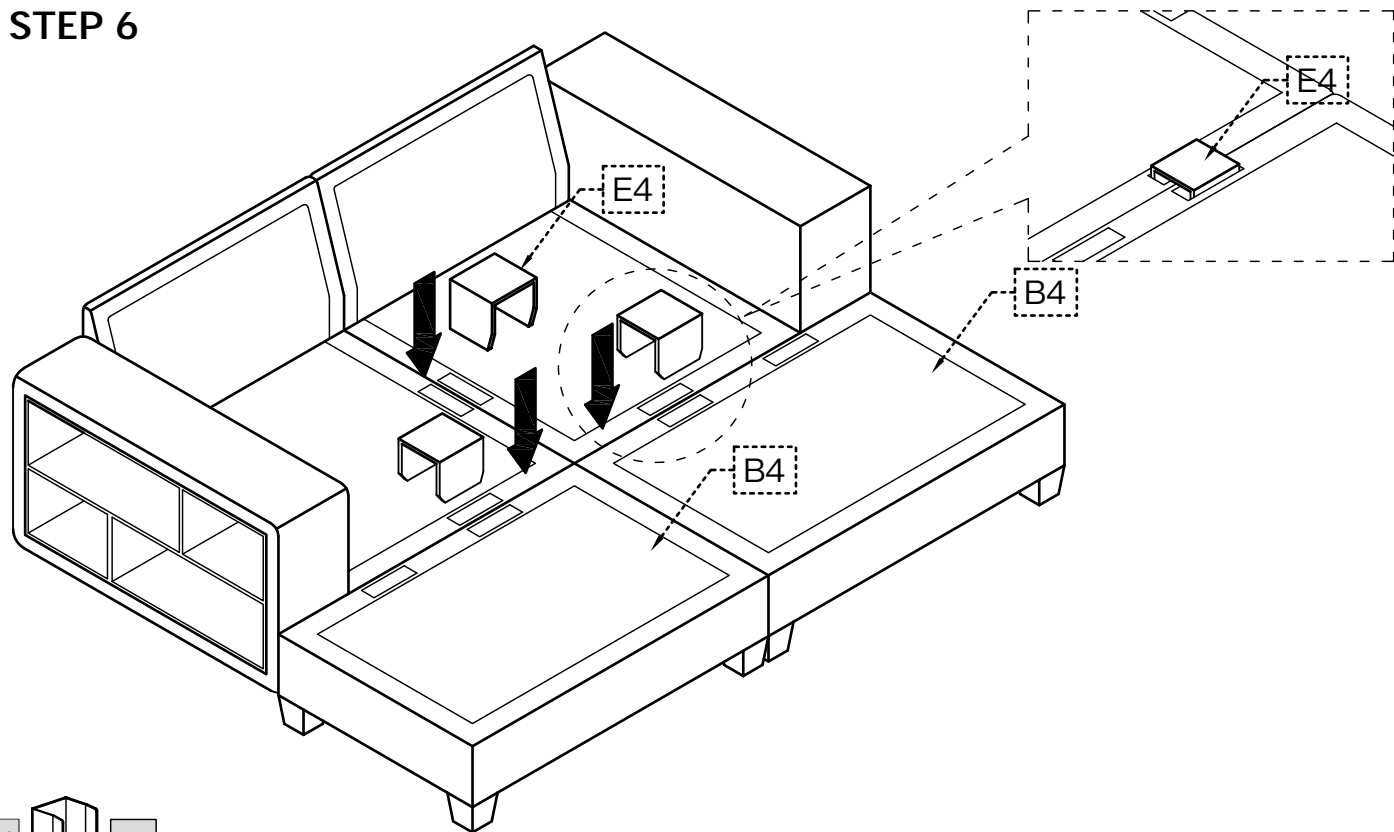

STEP 7

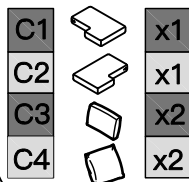
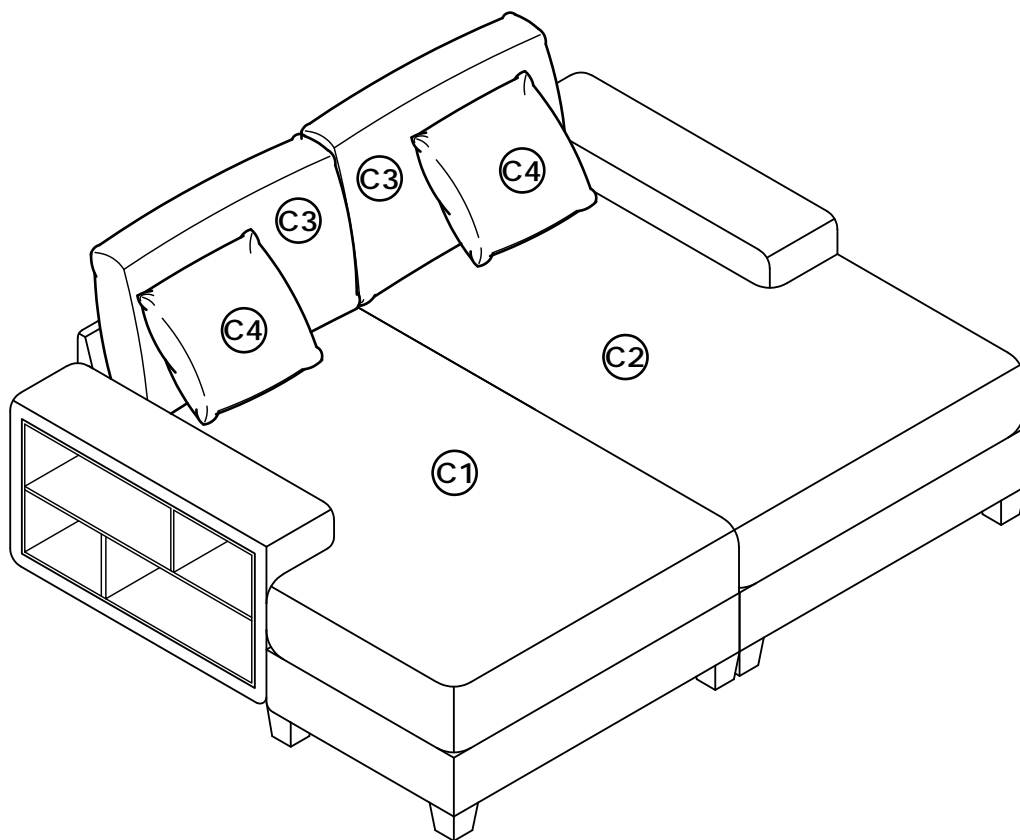



The installation of the combination A sofa is complete. If you purchased a combination B sofa, please follow the next steps to continue the installation

Combination A assembly steps

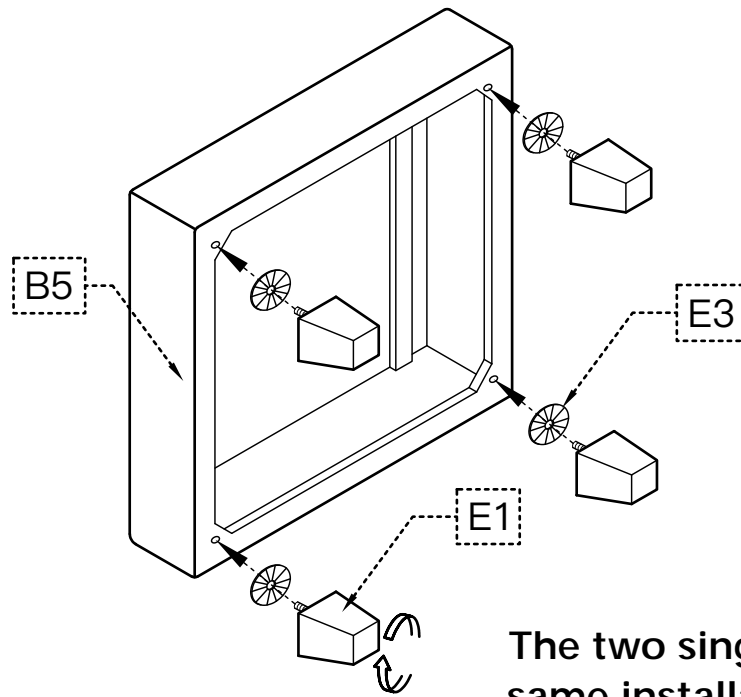
STEP 8



B5		x2
E1		x8
E3		x8

The two single seats adopt the same installation method.

STEP 9

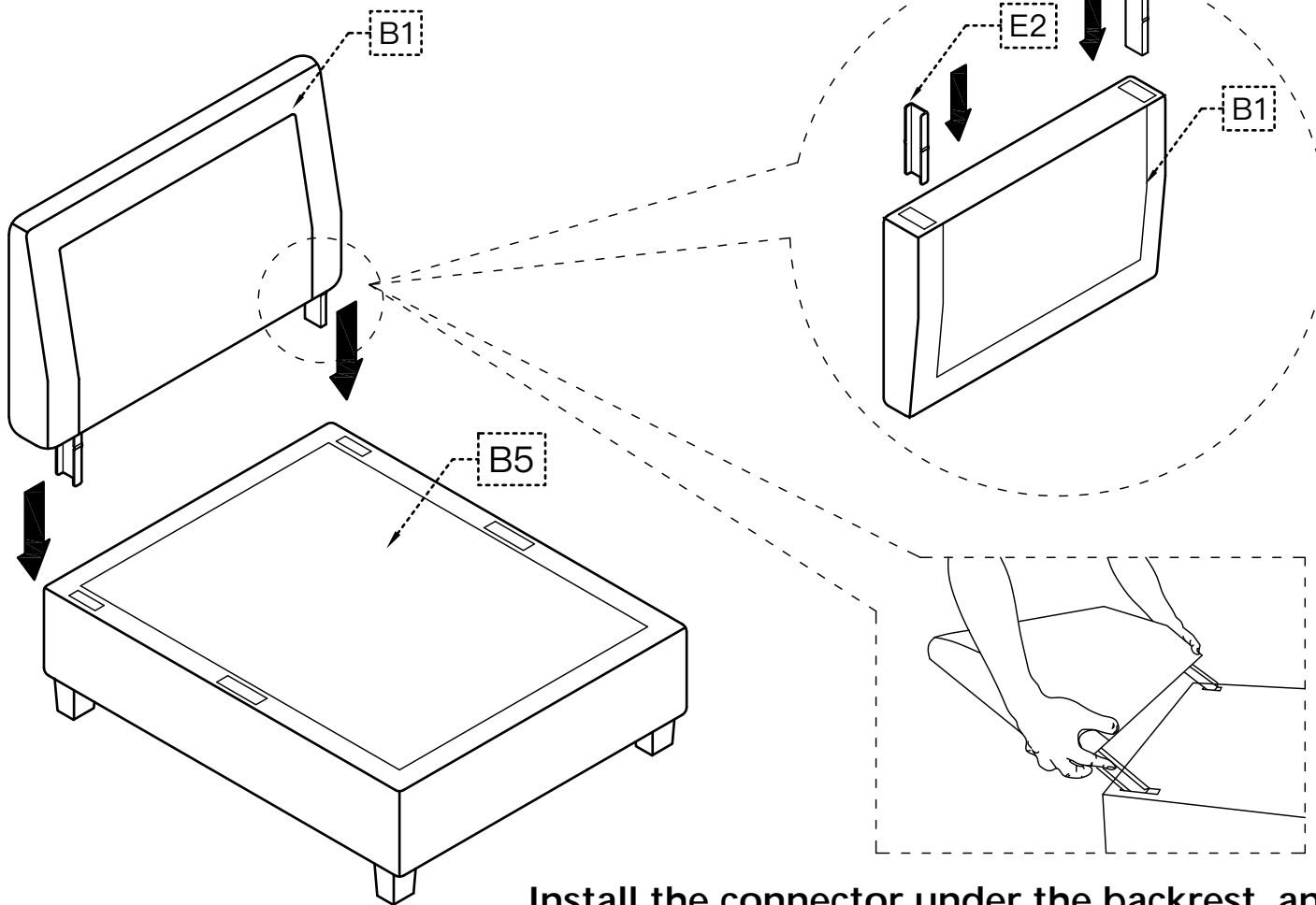

B1		x2
E2		x4

Install the connector under the backrest, and then insert it at the corresponding position at an angle of 45°. The left and right armrests are installed in the same way.

Combination B assembly steps

STEP 10

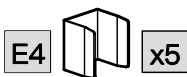
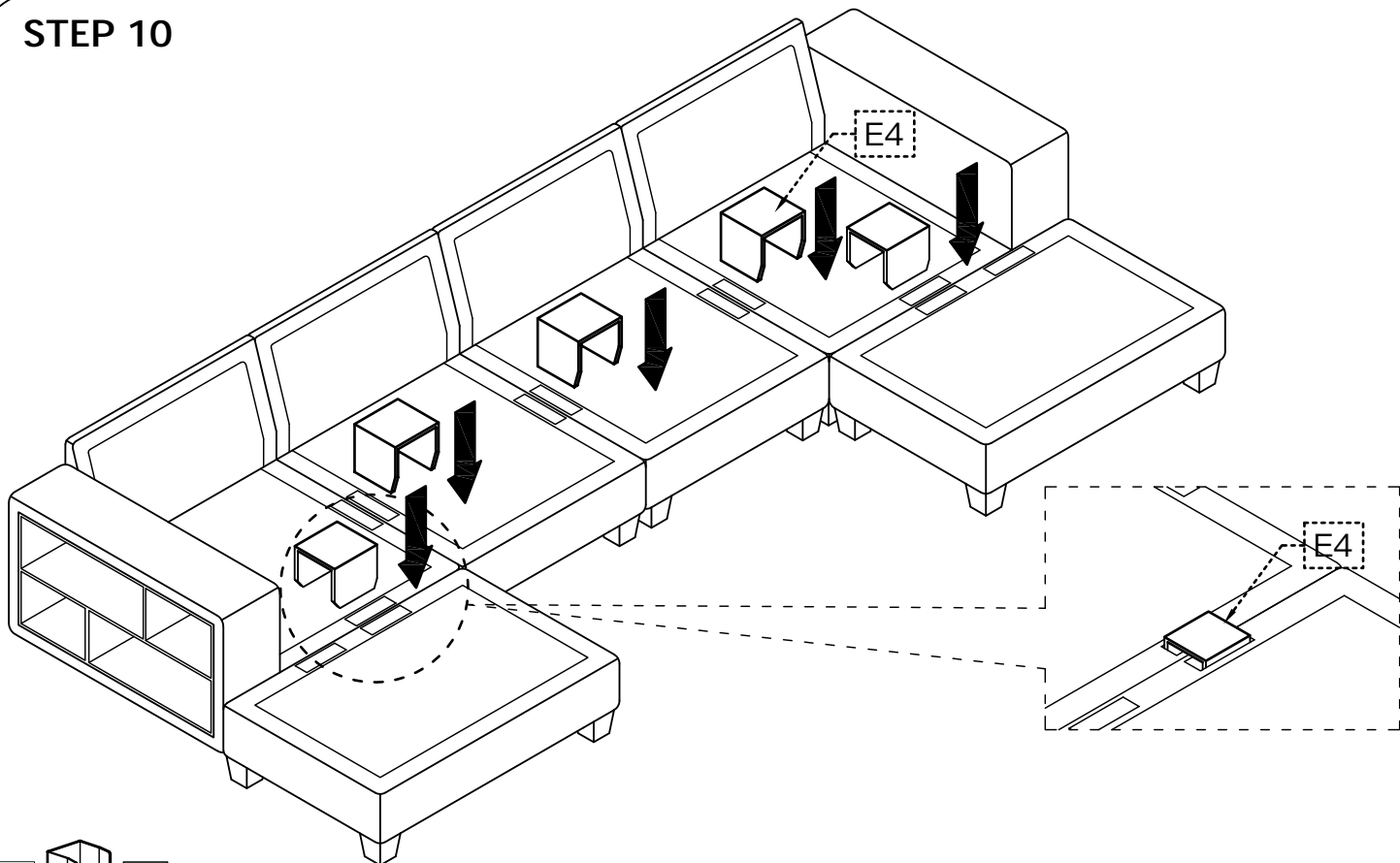

STEP 11

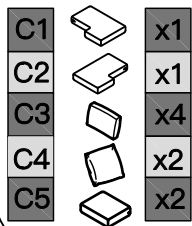
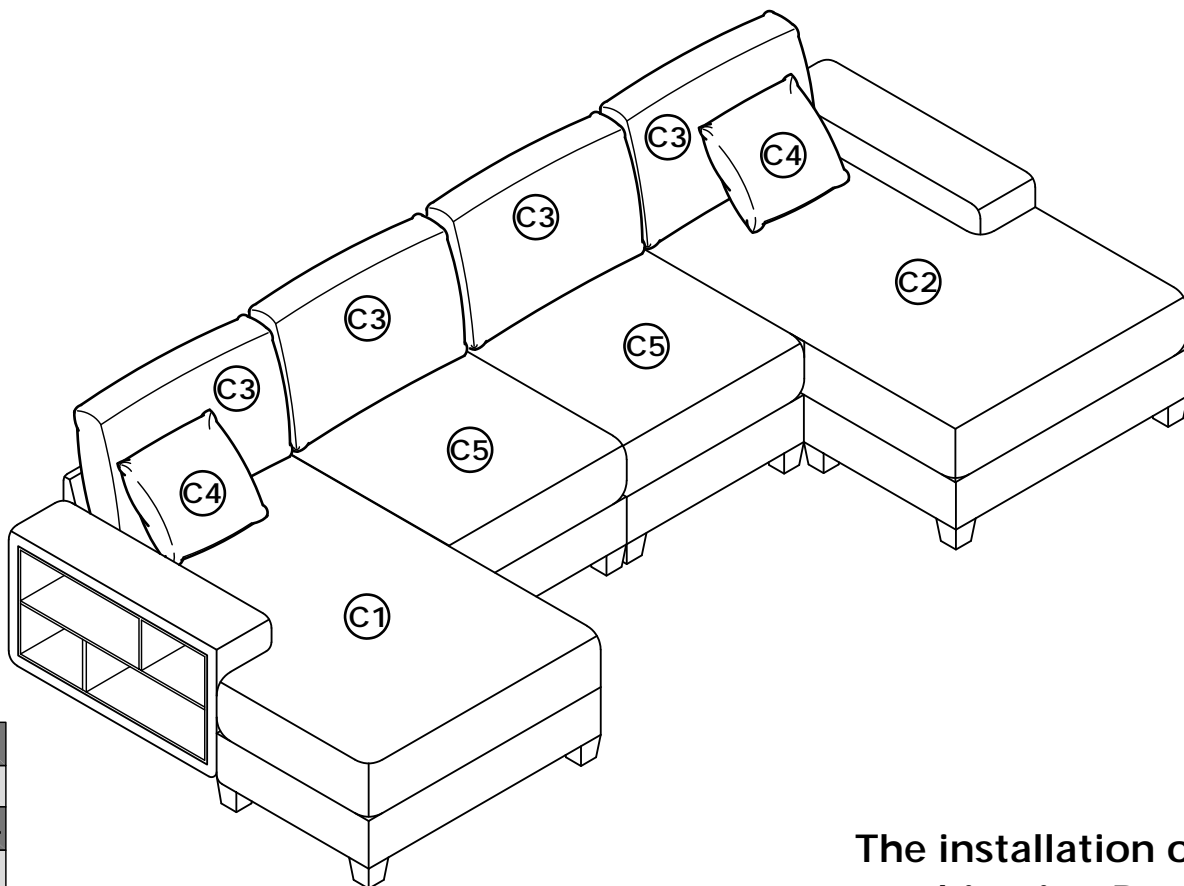

The installation of the combination B sofa is completed.