

---

## NOTE:

This brochure contains **IMPORTANT** safety info. Please read and keep for future reference.

---

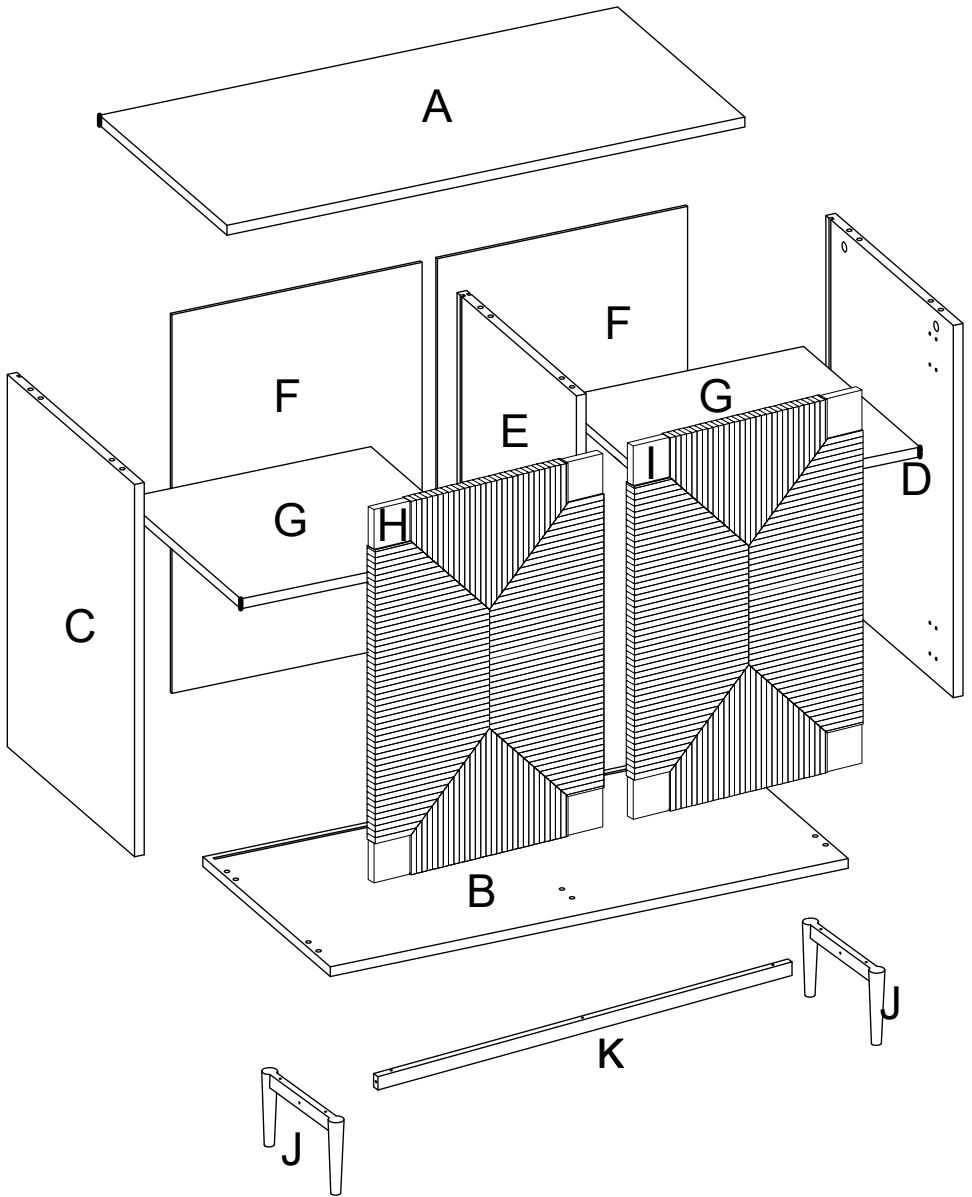

# OVERVIEW

## MAINTAINANCE AND WARNING







- Keep furniture away from heat sources.
- Do not clean furniture with harsh cleaner or polishes. Do not use detergents, Solvents, abrasives, spray packs or leather cleaner. Use non-color mild soap with warm water to clean spills (Mix 1:10 soap to water)
- Do not place furniture under direct sunlight, material will possibly fade over time.
- Do not use on site dry Cleaning machine. Children should not climb or jump on the furniture.
- Do not write on furniture that is not protected by a padded barrier .
- Not for commercial use, only for residential use.

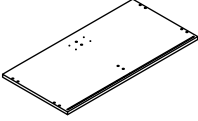
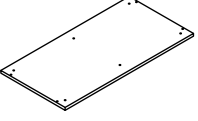

Weight Limitation

**100 LBS**

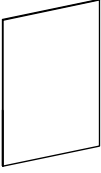
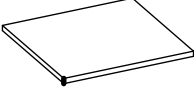
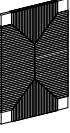
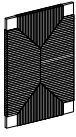
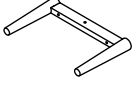





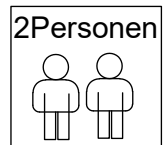









# PARTS LIST 1

<b>A</b>  1 PC	<b>B</b>  1 PC	<b>C</b>  1 PC	<b>D</b>  1 PC
<b>E</b>  1 PC	<b>F</b>  2 PCS	<b>G</b>  2 PCS	<b>H</b>  1 PC
<b>I</b>  1 PC	<b>J</b>  2 PCS	<b>K</b>  1 PC	



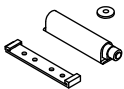



Persons Required For Assembly:



# PARTS LIST 2

①	x46	②	x6	③	x6	④	x12	⑤	x6	⑥	x4
											
M3.5*14		M7*50		Ø6*35mm		Ø8*30mm		Ø15*11mm		M4*35mm	
⑦	x7	⑧	x2	⑨	x12	⑩	x6	⑪	x2	⑫	x4
											
M6*50		M6*40				Ø20mm					
⑬	x1	⑭	x2	⑮	x4	⑯	x1	⑰	x4	⑱	x8
											
						M4		Ø8*30mm			

# SPARE

①	x1	②	x1	③	x1	⑥	x1	⑦	x1	⑧	x1
											
M3.5*14		M7*50		Ø6*35mm		M4*35mm		M6*50		M6*40	

Be sure to inspect all packing material carefully for small parts, that may have come loose inside the carton during shipment.

# STEP:1

picture shows. Use bolt ① to attach gasket ⑭ to door H&I, tighten bolts with screwdriver ⑬.

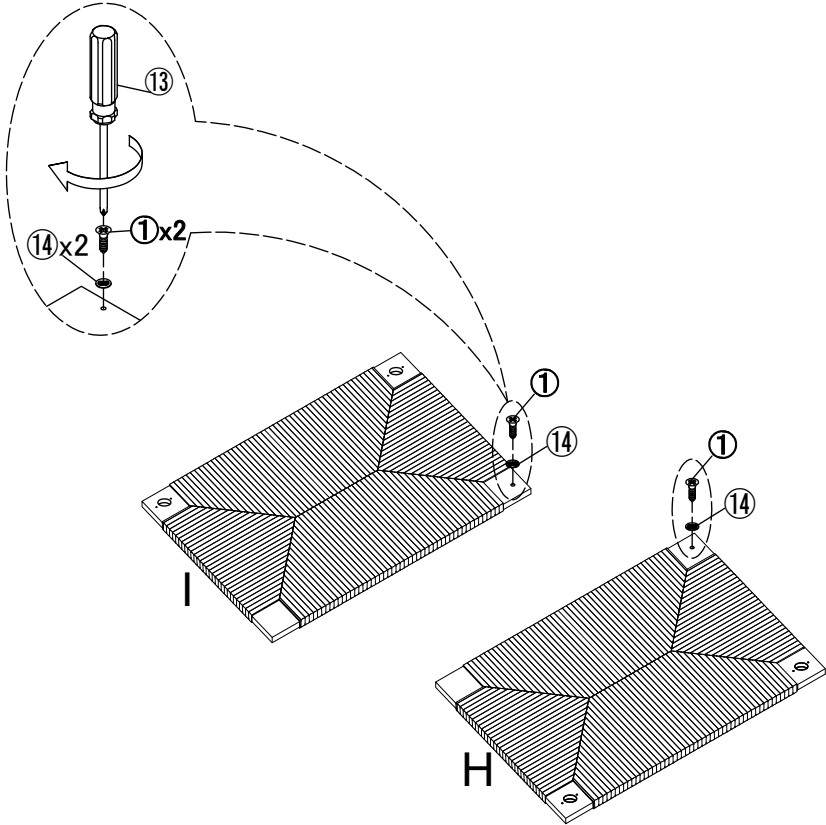

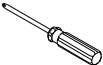
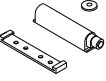

①	x2	⑬	x1	⑭	x2
					
M3.5*14					

# STEP:2

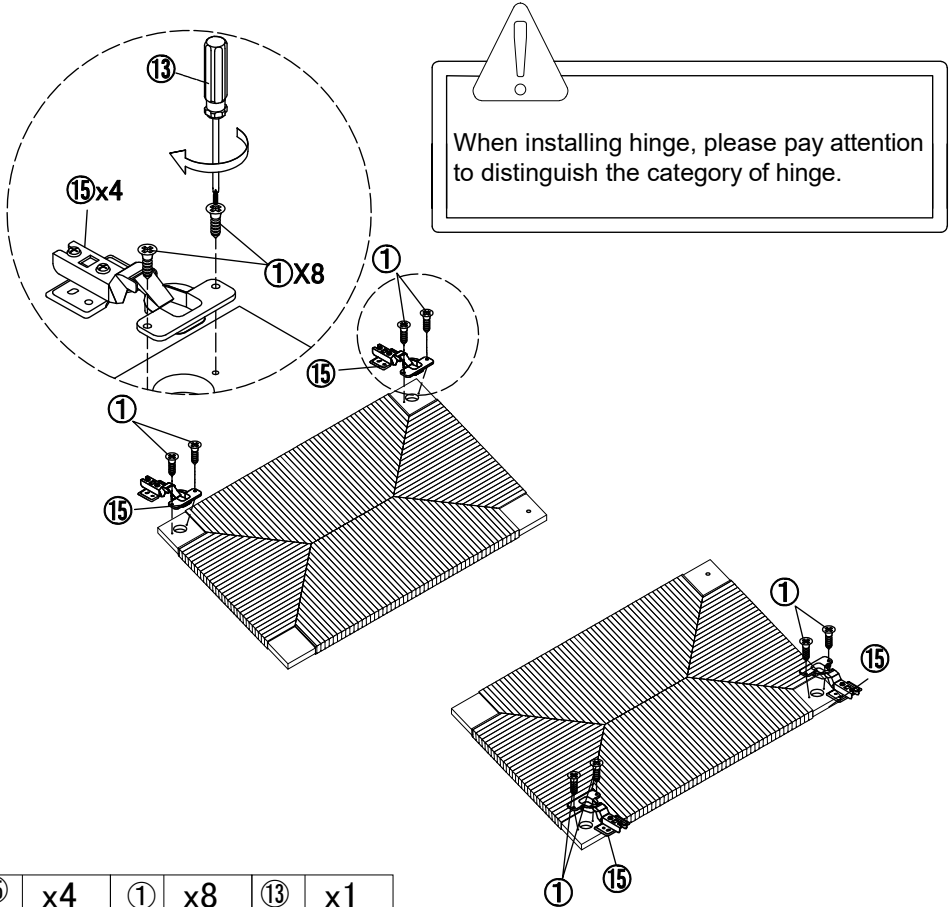
Use screw ① to attach the hinges ⑮ to door panel (H)&(I), tighten screws with screwdriver ⑬.

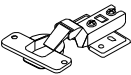

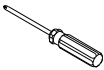
⑮	x4	①	x8	⑬	x1
					
		M3.5*14			

# STEP:3

Prepare for part A. Align the holes in part A, insert wooden dowel ④ by hand, tighten with screwdriver ⑬ and tighten ③.

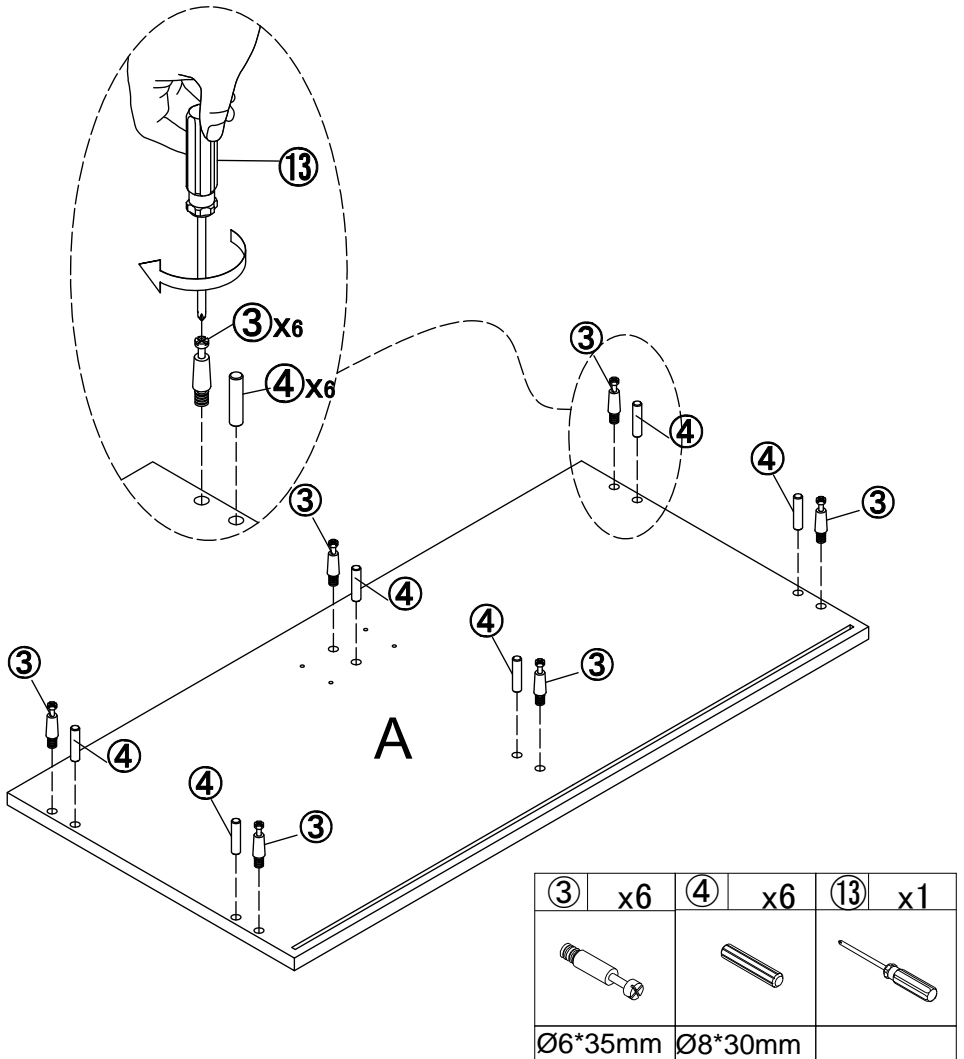

# STEP:4

picture shows. Use bolt ① to attach rebound device ⑭ to top panel, tighten bolts with screwdriver ⑬.

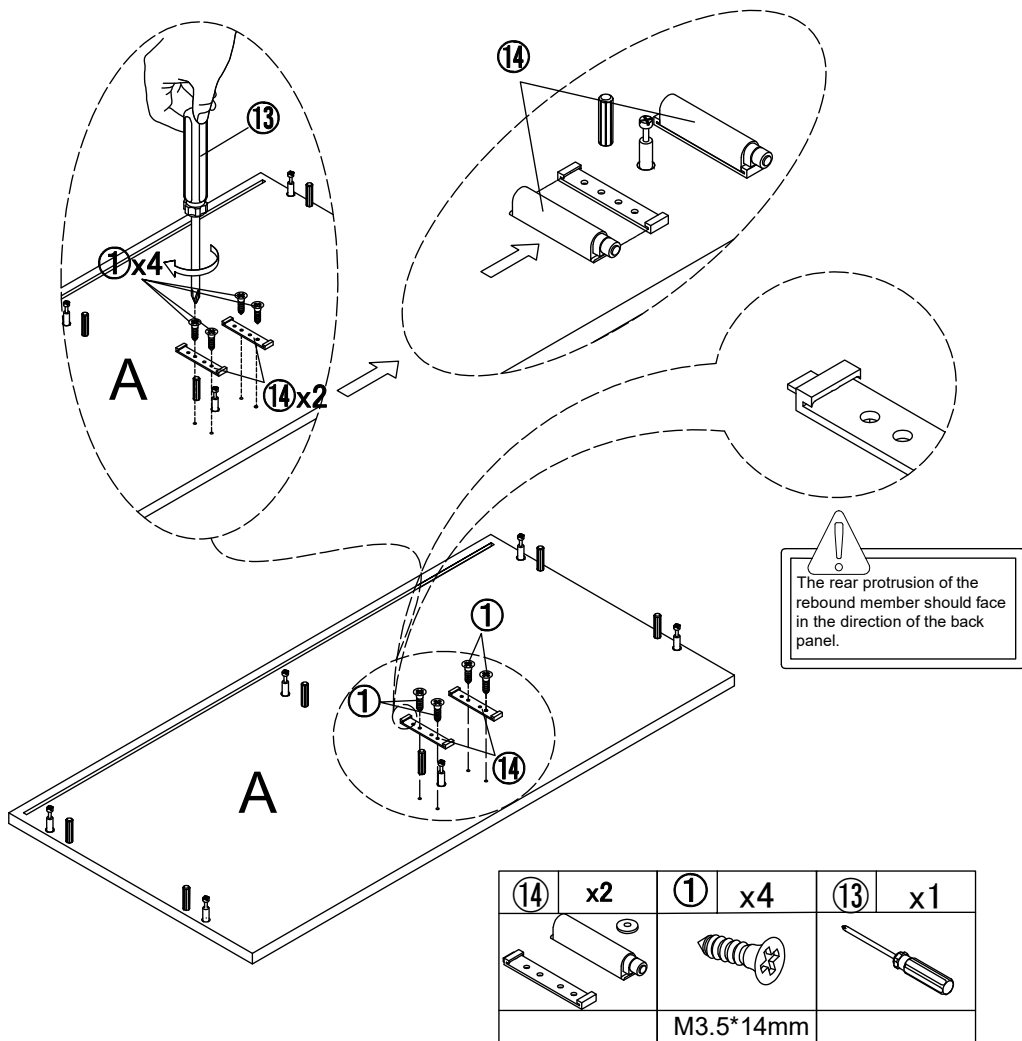

# STEP:5

Connect the part A with part (C,D,E). align the hole in the part (C,D,E),insert the bolt ③ and wooden dowel ④ in part A into part(C,D,E), and tighten the nuts⑤ with a screwdriver⑬.cover ⑩ the screw hole afte installation is finished. Make sure the groove is in same side as picture show.

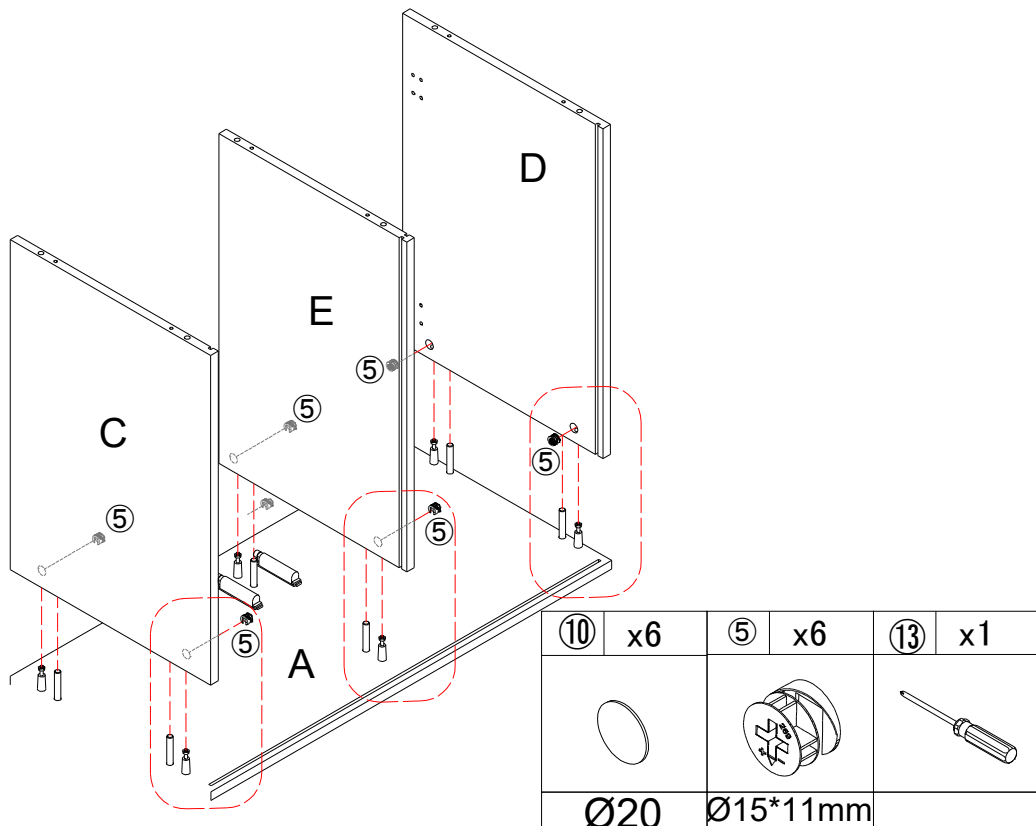
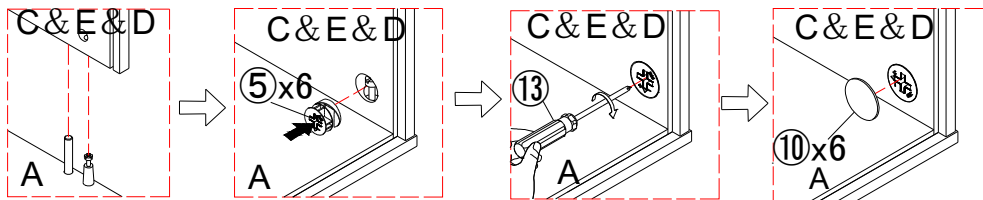

# STEP:6

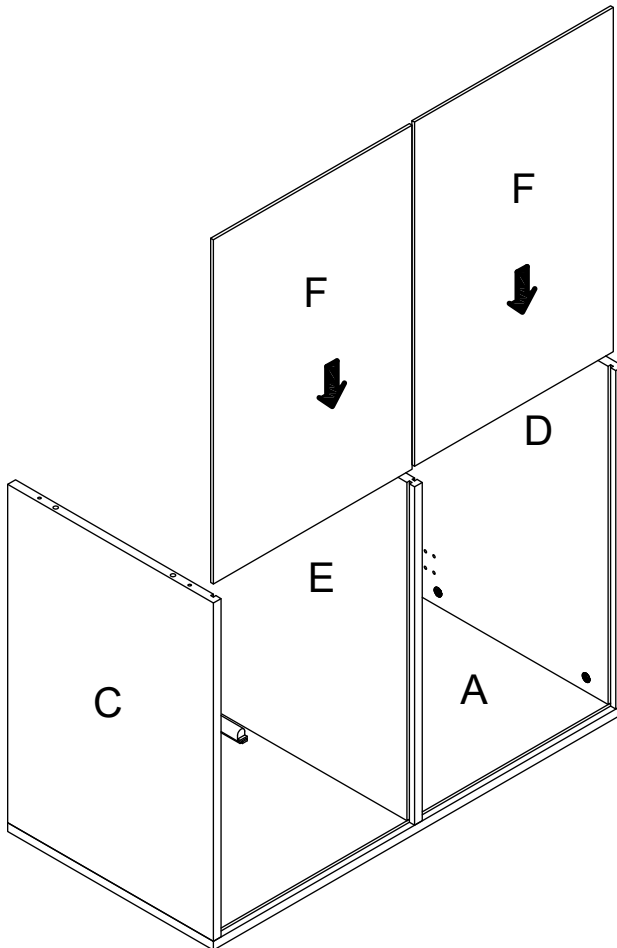

slide in the part (F) into the groove in part C,E and E,D. make sure they are also in groove in part A.

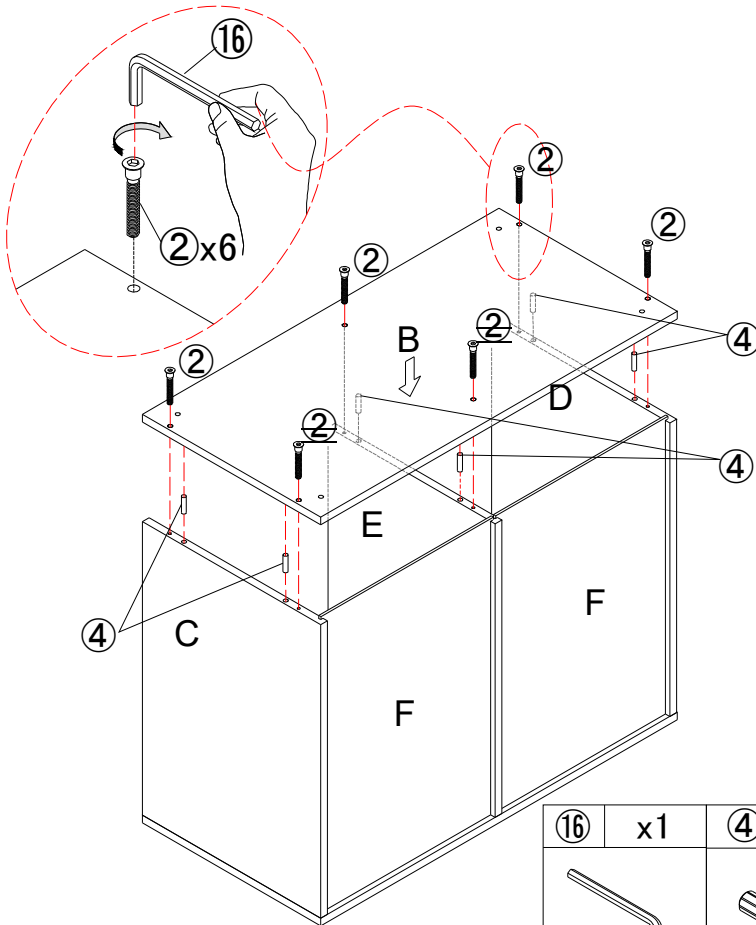

# STEP:7

Connect the part B the pre-assembled unit in step 5. Insert the wooden dowel ④ into the part (C,E,D) as the picture show. Then align the holes in part B insert screw ② and push it down so that it connects to parts (C,E,D). Next, and tighten the screw ② with an Allen key ⑩.

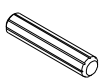

⑩	x1	④	x6	②	x6
					
M4		Ø8*30mm		M7*50	

# STEP:8

Prepare the leg racks. Align the holes of the J part with the holes of the K part, install the screw ⑧, and tighten the screw ⑧ with the allen key ⑯.

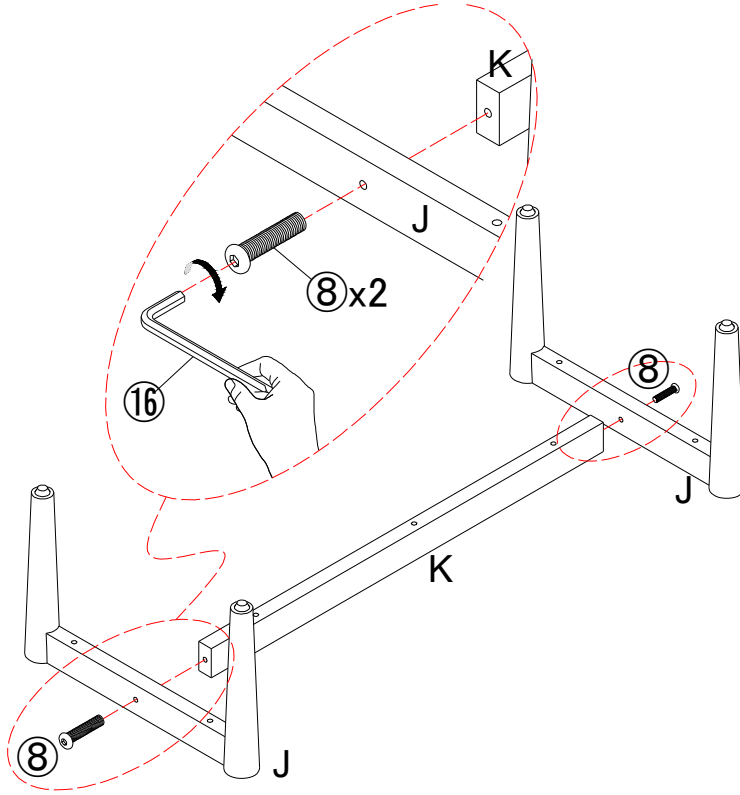

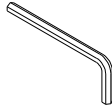
⑧	x2	⑯	x1
			
M6*40		M4	

# STEP:9

connect the leg frame to the cabinet. Attach the leg frame to the pre-assembled unit in step 6 with a screw ⑦ and tighten with a allen key ⑩.

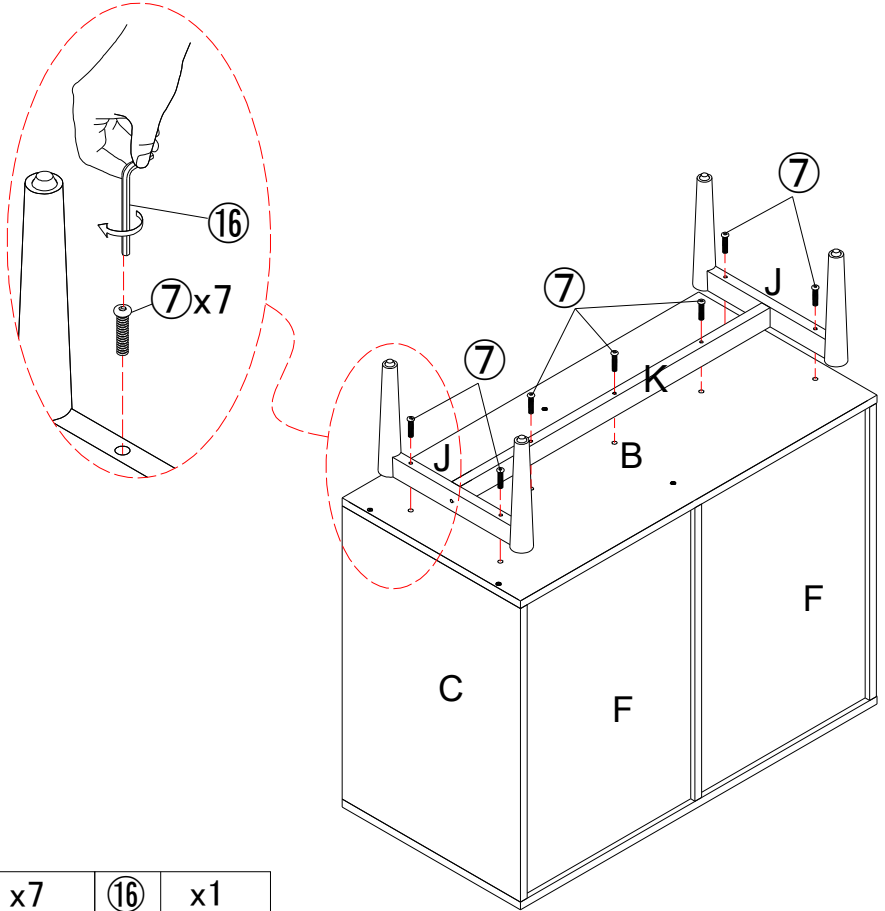

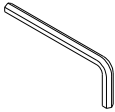
⑦	x7	⑩	x1
			
M6*50		M4	



# STEP:11

Use screw ① to attach left door (H) and right door (I) to pre-assemble unit at step 9 ,tighten screw with screwdriver ⑬ .

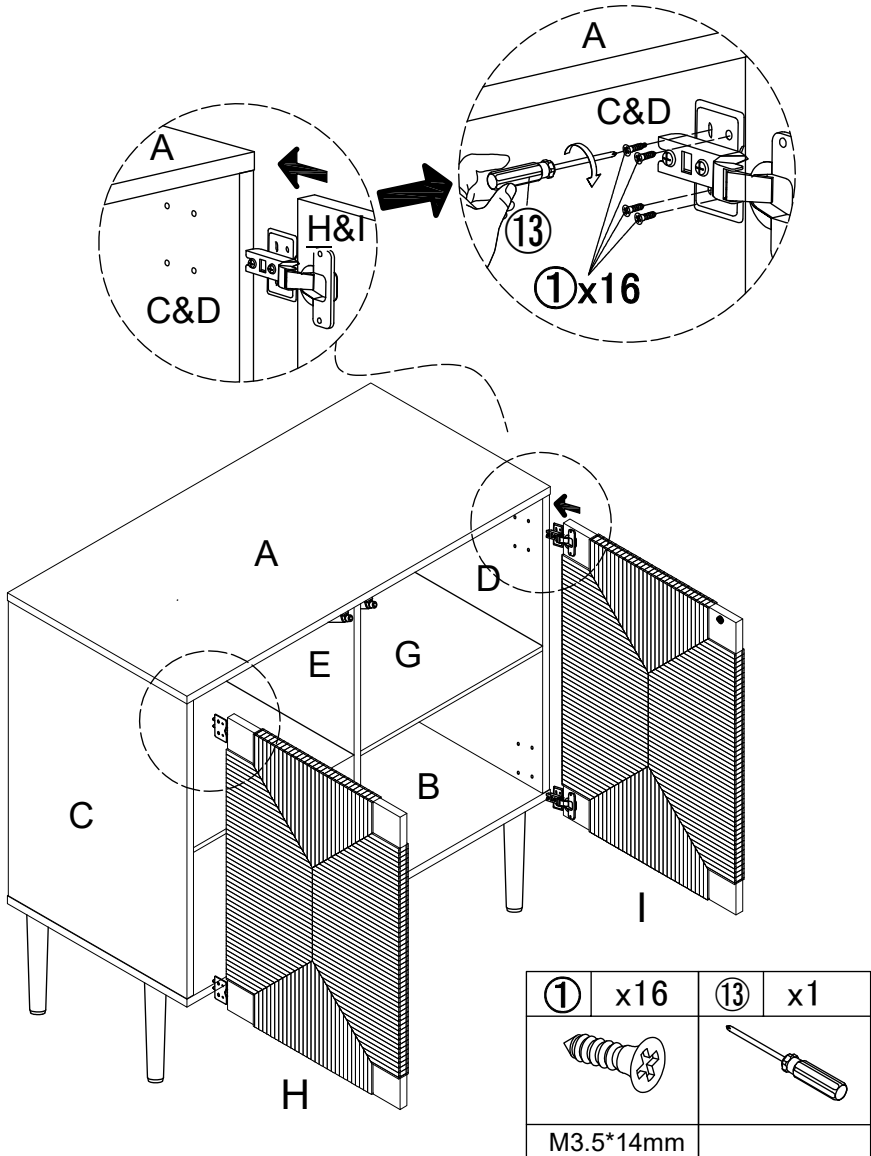

# STEP:12

Attach part ⑨ to parts F,F with bolt ① and tighten the bolt with screwdriver ⑬.

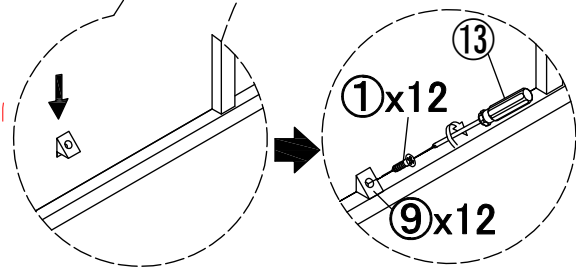
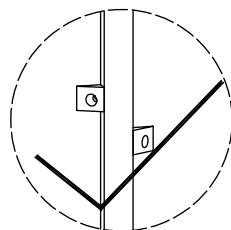
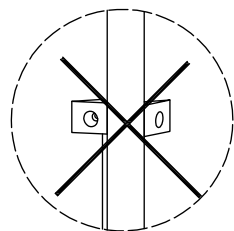
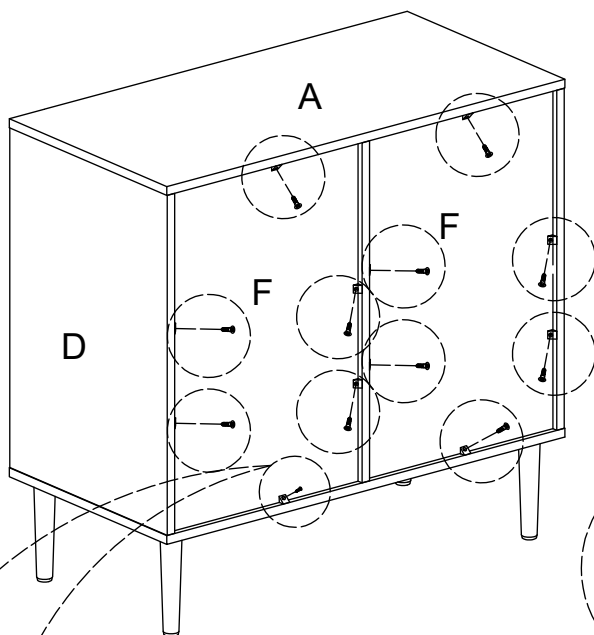

⑨	x12	①	x12	⑬	x1
		M3.5*14mm			

# STEP:13

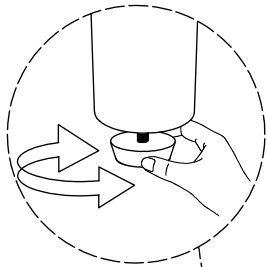
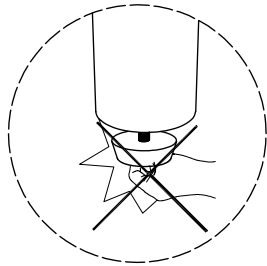
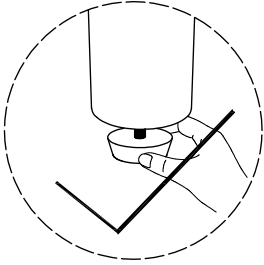

**Attention:**

After installation, adjust the adjustable leveler to keep the cabinet balanced.

Be sure to check all packing material carefully for small parts, which may have come loose inside the carton during shipment.

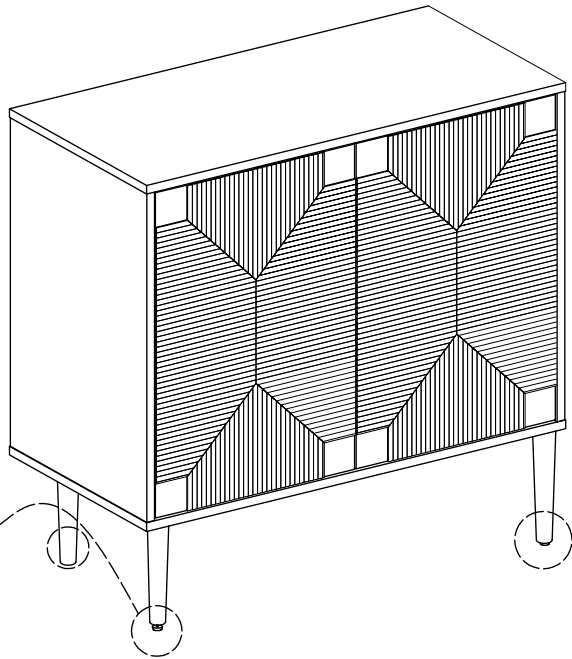

Concealed hinges are three-way adjustable:

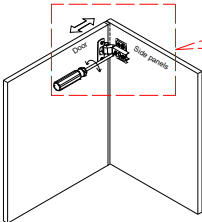

Horizontal  
by screw adjustment!

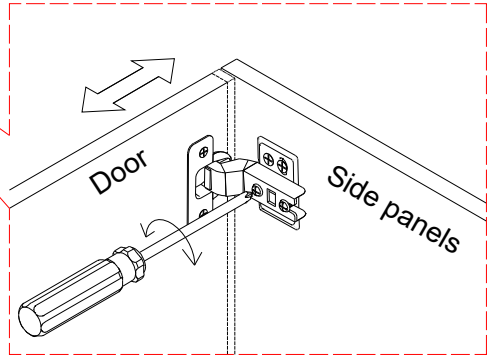

Concealed hinges are three-way adjustable:

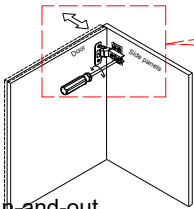

In-and-out  
by loosening the hinge arm  
mounting screw or via cam  
adjustment!

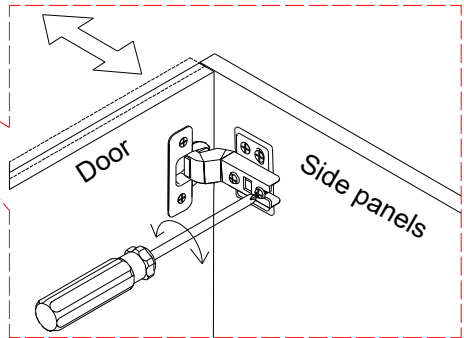

Concealed hinges are three-way adjustable:

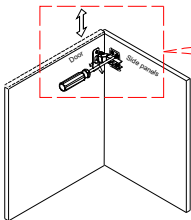

Vertical via slots in  
the mounting plate  
or via cam adjustment!

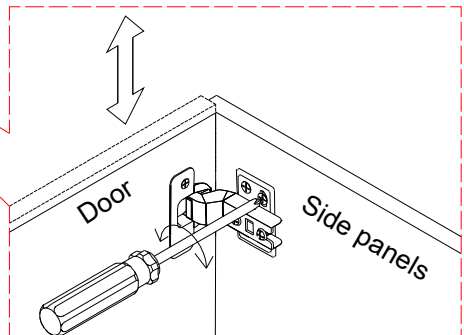



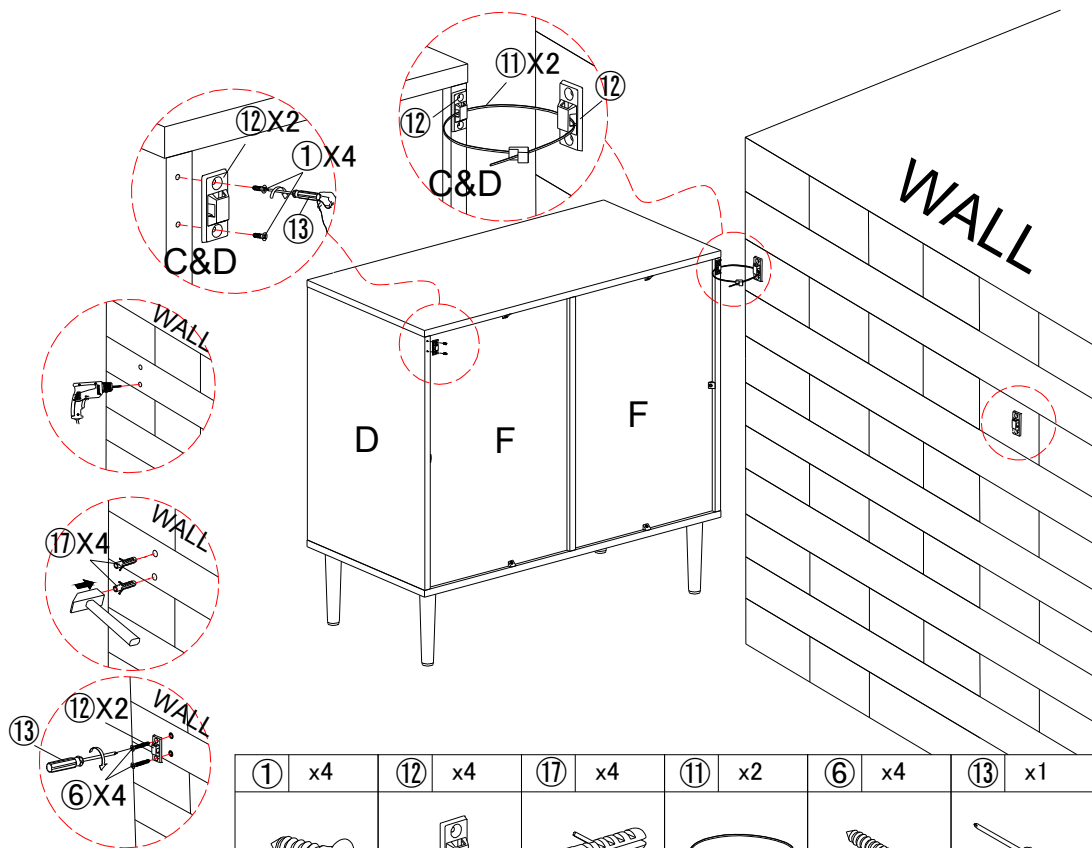

## Hinge adjustment method

# STEP:14

Attach part ⑫ to parts D, C with bolt ① and tighten the bolt with screwdriver ⑬. Mark the position on the wall, that corresponds to the location of part ⑫ on the side panel D,C; Drill and insert the expandable screw ⑰ by hammer. Assemble the part ⑫ to the wall. Align the hole in the part ⑫ with the expandable screw ⑰, use screw ⑥ to attach it and tighten by screwdriver ⑬. Let the plastic belt ⑪ pass through the both part ⑫ and pull tightly.

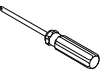

①	x4	⑫	x4	⑰	x4	⑪	x2	⑥	x4	⑬	x1
											
M3.5*14				Ø8*30mm				M4*35			

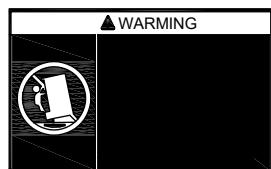

# WARRANTY

We strive to offer high-quality products, and we also try our best to satisfy each and every customer that orders from us with product or service as needed. We provide 30 days warranty starting from the time you receive the item. Each customer must provide a record of their order such as the order number, or item receipt for any items that are out of the warranty period you may also still receive replacement parts by purchasing them with our company if they are available.

Appreciate your purchasing from us.  
Pop up your life by our furniture piece!