

Owner Manual

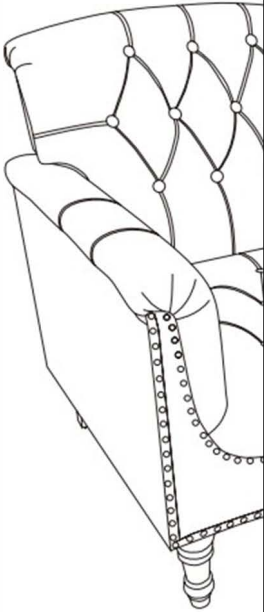

WARRANTY

We strive to offer high quality product and we also try our best to satisfy each customer that order from us, no matter on products or services as needed. Each customer receives a record of their order, such as the order number or item receipt. For any items that are out of warranty period, you may still be able to purchase the replacement parts from our company if they are available.



MAINTENANCE AND WARNING

Please read the manual thoroughly
before you start installing.

Please keep the product away from
sharp object.

Packaging and small parts may have
chocking hazard, please keep them away
from children and pets.

Please clean the product according to each
clean code, check the product description
for more information.

Please keep the product away from
fire.

If you have any other questions, please
contact us, we will be glad to help you out.

If the product is placed under direct
sunlight, the pattern or color might fade
away overtime.

Check the product periodically to make
sure everything is secured and tightened.

Always use proper tools for installation.

Do not jump on the product.



One people



0-3

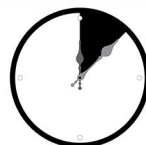

Around 20 min

PRODUCT DESCRIPTION



Classic nailhead trim and a tufted backrest bring a timeless retro charm, elevating the style of any space.

The soft, silky leather offers a luxurious feel while being durable and easy to maintain.

The seat is crafted with high density foam, synthetic fibers, and spring support, ensuring long lasting comfort and bounce without sagging.

Built with a durable solid wood structure and reinforced legs, it supports up to 220 pounds, providing reliable stability.

Designed to combine classic aesthetics with modern practicality, this chair is an ideal addition to any living room, office, or cozy corner.

EXPLODED VIEW

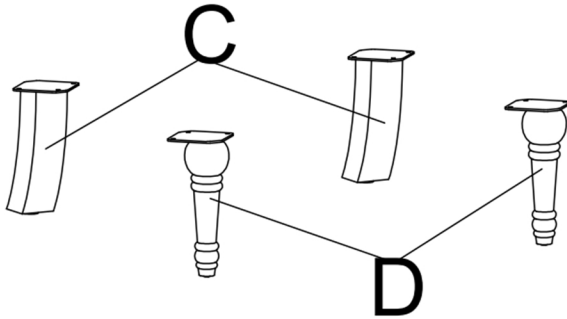
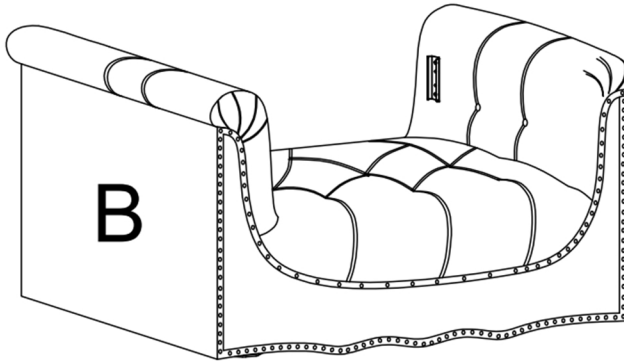
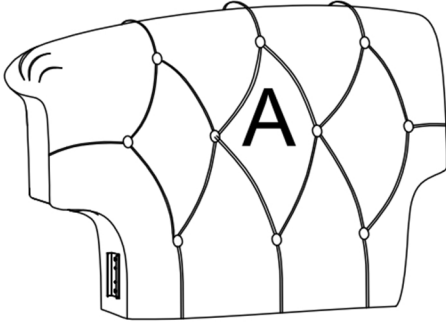

PARTS

A*1

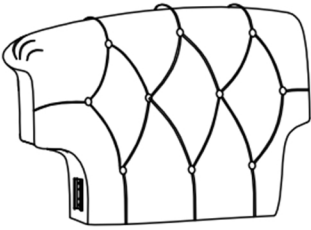

Backrest

B*1

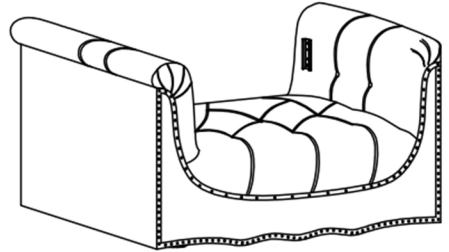

Seat frame

C*2



Rear legs

D*2



Front legs

HARDWARE

TOOL LIST

NOTE: Designated with (★) We provide additional spare parts in the hardware package

①*12

M6*20mm



★ Bolt

②*1

M6



Allen Key

Please make sure all hardware&packing material fitting the list. Especially some small accessories may be missing during transportation. Please contact us if you have any question.

step 1

Take out all the legs (C&D) from the bottom of seat frame, use allen key (2) provided to tighten the bolts (1) as shown.

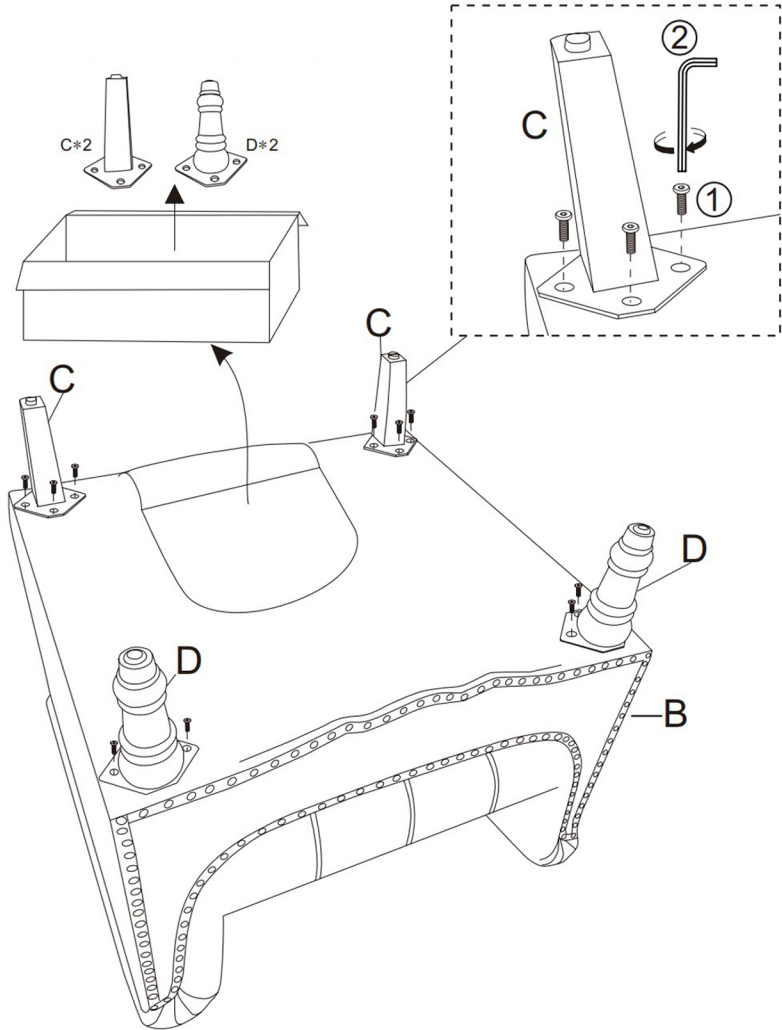

step 2

Install the backrest (A) to the seat frame (B) by inserting the connectors into the slots as shown, make sure they are both correctly aligned before pushing it down.

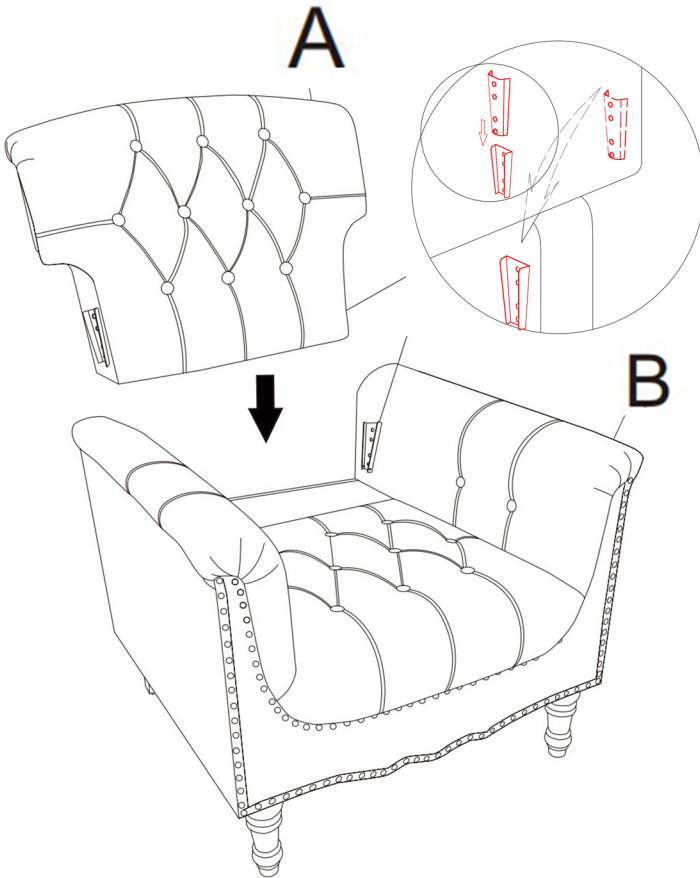

step 3

Please note: the legs of the chair can be adjusted by twisting the leveler on the tip of the legs as shown, it can help you use this chair on ground that is not flat, please check before you use the chair.

