



## Assembly Instruction

**CAUTION:** Read instruction carefully and turn electricity off at main circuit breaker panel before beginning installation.

**ITEM#:DSN1300A**

**Product Dimensions: 16.5"x 16.5" x 26"H**

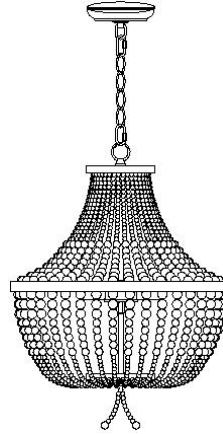

### Care and Cleaning













To clean the outside of the fixture, use a dry or slightly dampened clean cloth (use clean water, never a solvent) to wipe the surface of the fixture.

To clear the inside of the fixture, first disconnect power to the fixture by turning off the circuit breaker or by removing the fuse at the fuse box. Next, use a dry or slightly dampened clean cloth (use clean water, never a solvent) to wipe the interior surface of the fixture.

Do not use any cleaners with chemical, solvents or harsh abrasives. Use Only a dry soft cloth to dust or wipe carefully.

Estimated Assembly Time: 30 minutes

### Part List and Hardware List

PIECE	DESCRIPTION	PICTURE	QUANTITY	PIECE	DESCRIPTION	PICTURE	QUANTITY
A	Mounting Plate		1X	G	Chain		1X
B	Wire Nut		3X	G1	Closable link		2X
C	Mounting Screw		2X	H	Fixture Loop		1X
D	Canopy		1X	I	Shade		1X
E	Hanging Loop		1X	J	Socket Assembly		1X
F	Canopy Nut		1X	K	Bulb		3X

# Installation

## Step 1

Unpack all parts from cartons carefully.

Attach the Closable Link(G1) onto the Hanging Loop(E and H)

Put the wire in the ring(like number 3/7/11 and so on) every three rings as right picture.

Put the wire through the nut(F)and loop(E)and canopy(D)and plate(A)

Place the Canopy(D)onto the Hanging Loop(E)

Place the tube of Mounting Plate(A)into the threaded portion of the Hanging Loop(E) and fix it by turing the Canopy Nut(F) clockwise till tight.

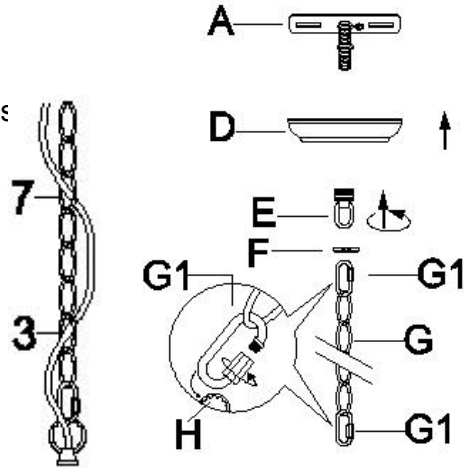

## Step 2 Wire connection

Connect,Hot,Black or Red outlet Supply Wire to:	Connect,Neutral,White Outlet Supply Wire to:
Black	White
*Parallel Cord(round&smooth)	*Parallel Cord(square&ridged)
Clear,Brown,Gold or Black without Tracer(colored stripes)	Clear,Brwn,Gold or Black without Tracer(colored stripes)
Insulated Wire(not green)with silver metal conductor	Insulated Wire(not green)with Silver metal conductor

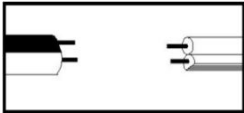

\*Note: When parallel wire(SPTI&SPTII)is used. The neutral wire is square shaped and ridged and the hot wire will be round in shape and smooth.(See illustration on left)



Grounding Instructions:

a) For installation in the United States: Wrap ground wire from outlet box around green ground screw on mounting bracket, no less than 2" from wire end. Tighten ground screw. If fixture is supplied with a ground wire, connect to outlet ground wire with a wire connector.

b) For installation in Canada: If fixture is supplied with ground wire, wrap ground wire around green grounding screw on mounting bracket. Tighten ground screw.

## Step 3

Seperate the Mounting Plate(A) from the Canopy(D) by turning the Canopy Nut(F) anti-clockwise.

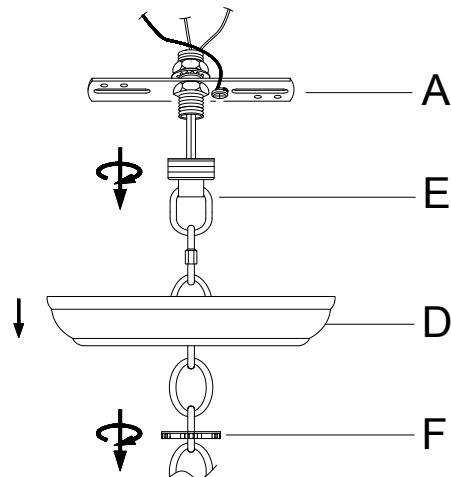

## Step 4

Install the Mounting Plate(A) to the junction box with Mounting Screw (C)

Attach the Canopy(D) to the junction box and fix it by turning the Canopy Nut(F) clockwise

Insert the bulbs (K) into the Sockets

**PLEASE USE ON/OFF TYPE "B" BULB MAX 40-WATT OR CFL BULB MAX 13-WATT OR LED BULB MAX 9-WATT  
THERE IS LED 4-WATT BULB IN THE BOX**

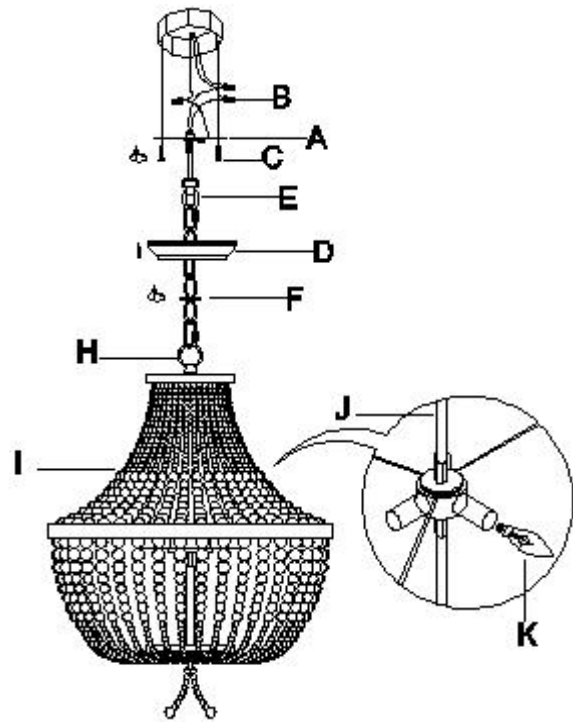

## Step 5

Consult a qualified electrician to ensure correct branch circuit conductor.

ENJOY YOUR LAMP