







# ASSEMBLY INSTRUCTIONS

**(BOX 1)**  
BOX OF NIGHT STAND

NO	ITEM	QTY
A	NIGHT STAND 	1 pc
B	BUN FOOT 	4 pcs

**(BOX 1)**  
HARDWARE LIST

NO	ITEM	QTY
1	JCBC Bolt m6x50mm Blk 	4 pcs
2	Spring Washer 1/4" Blk 	4 pcs
3	Flat Washer 1/4"IDx13mmOD Blk 	4 pcs
4	Allen Key m4x110mm With Ball Blk 	1 pc

**STEP 1 :** Pull the bottom drawer and take out the Bunfoot carton ( B ). Assemble the Bun Foot (B) with JCBC Bolt (1),Spring washer (2),Flatwasher (3) and securing with Allen Key (4) as shown.

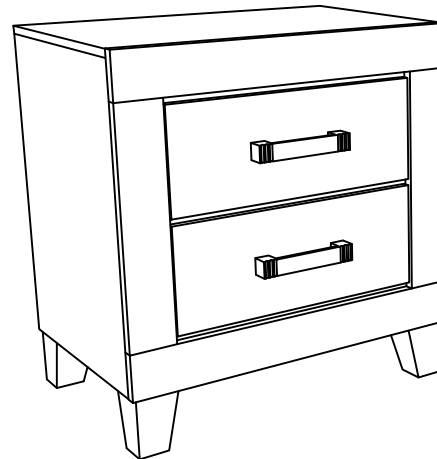
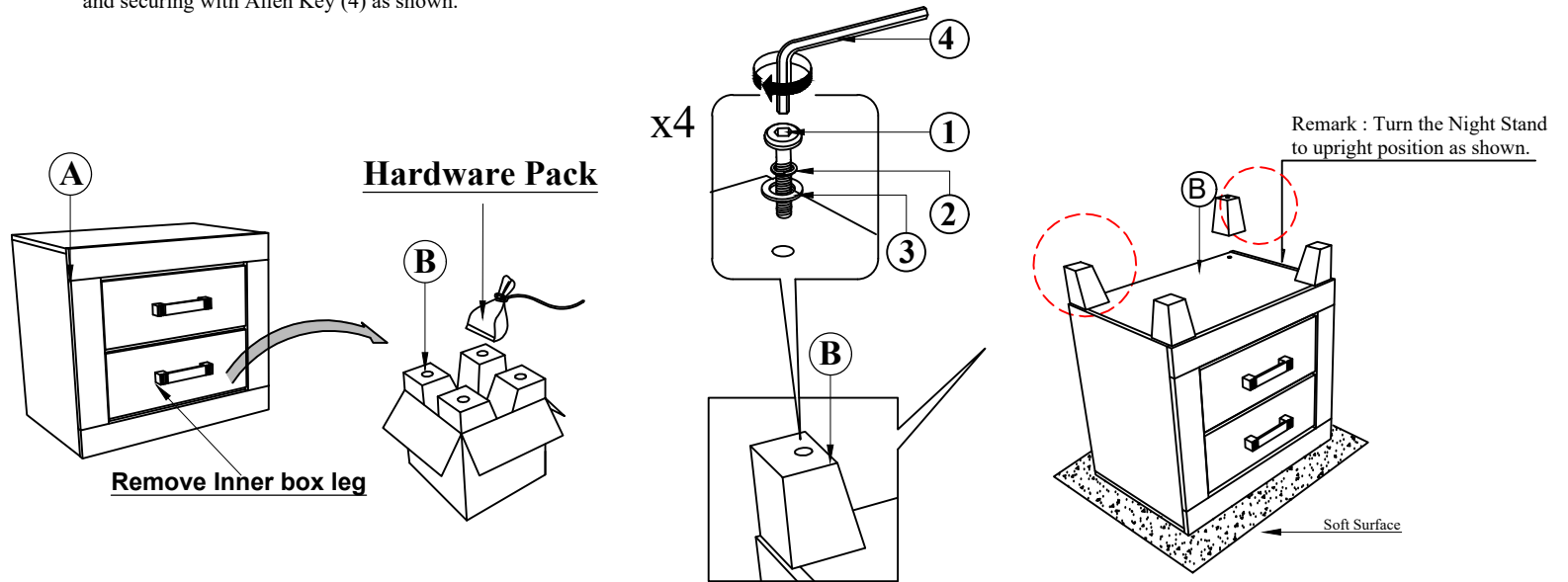

**COMPLETED ASSEMBLY**

NOTE : MUST TIGHTEN SCREWS **PERIODICALLY** WITH USE SCREW WILL BECOME LOOSE CHECK TIGHTNESS OF ALL SCREW EVERY 6-8 WEEKS.