

# ASSEMBLY INSTRUCTION











Thank you for purchasing this quality product. Be sure to check all packing material carefully for small parts which may have come loose inside the carton during shipment. Separate, identify and count all parts and hardware. Compare with the parts list to be sure all parts are present.

**"DO NOT TIGHTEN SCREWS UNTIL COMPLETELY ASSEMBLED"**









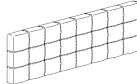

## IMPORTANT:

PLEASE READ INSTRUCTION BEFORE STARTING THE ASSEMBLY

### HARDWARE LIST

ITEM	DESCRIPTON	DRAWING	SIZE	QTY
A	JCBB SCREW		M8 x 20MM	8PCS
B	JCBC SCREW		M6 x 25MM	8PCS
C	JCBC SCREW		M6 x 35MM	20PCS
D	JCBC SCREW		M6 x 50MM	6PCS
E	JCBC SCREW		M6 x 70MM	2PCS
F	WOOD DOWEL		M8 X 30MM	2PCS
G	SPRING WASHER		13MM	30PCS
H	FLAT WASHER		19MM	30PCS
I	SCREW		M4 x 32MM	8PCS
J	L - KEY		M5 x 65MM	1PC
K	L - KEY		M4 x 100MM	1PC

### PART LIST

ITEM	DESCRIPTON	DRAWING	QTY
1	HEADBOARD CUSHION		1PC
2	HEADBOARD LEG		1PC
3	HEADBOARD LEG		1PC
4	FOOTBOARD CUSHION		1PC
5	FOOTBOARD LEG		2PCS
6	SIDE RAIL		2PCS
7	SIDE RAIL		2PCS
8	CLEAT		4PCS
9	SIDE RAIL SUPPORT LEG		2PCS
10	SLAT		4PCS
11	SUPPORT LEGS WITH ADJUSTABLE FEET		4PCS

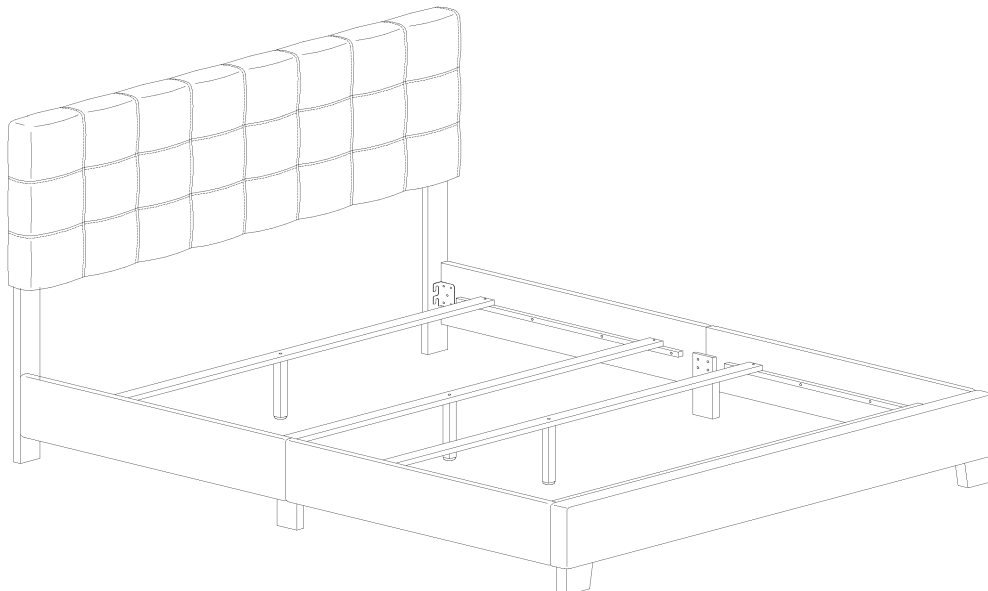

# ASSEMBLY INSTRUCTION

STEP 1

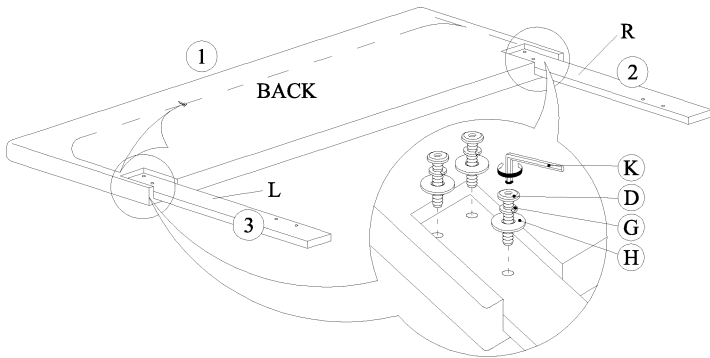

STEP 2

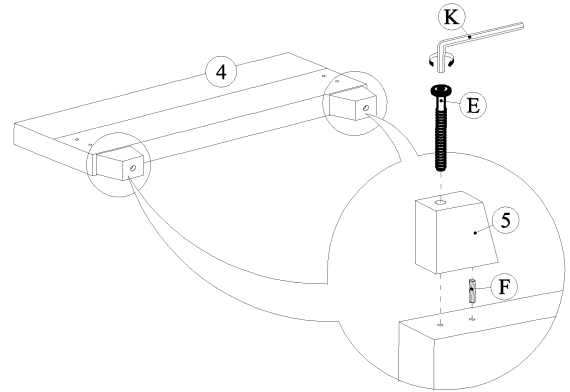

STEP 3

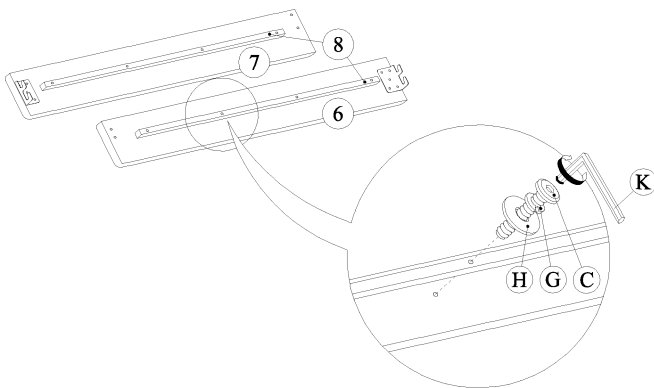

STEP 4

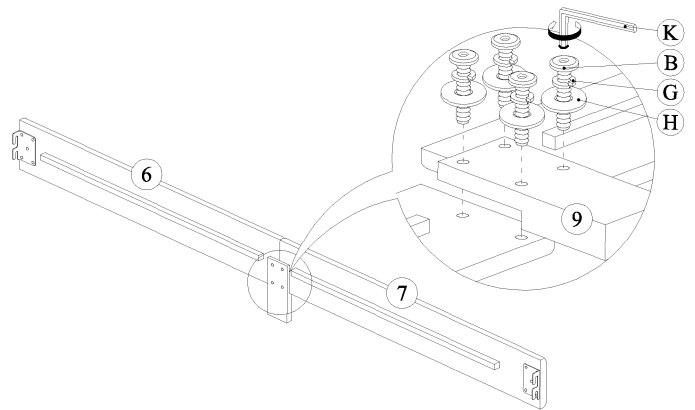

STEP 5

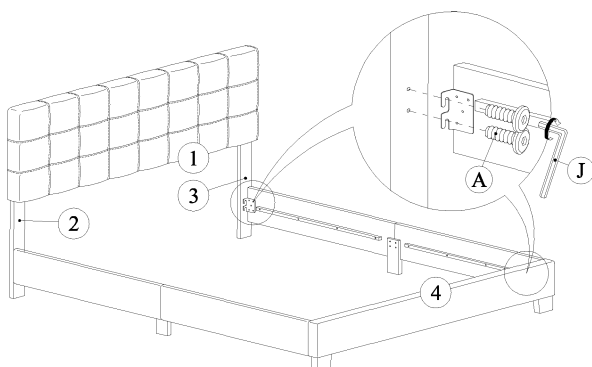

STEP 6

