

STEP:1

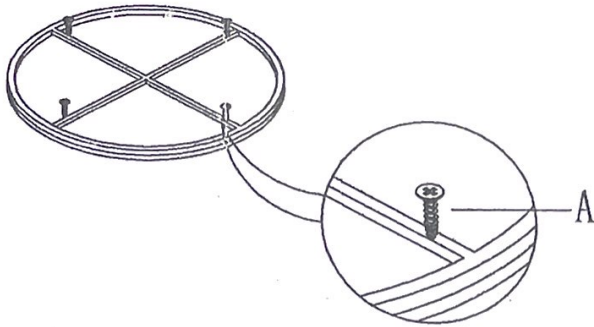

STEP:2

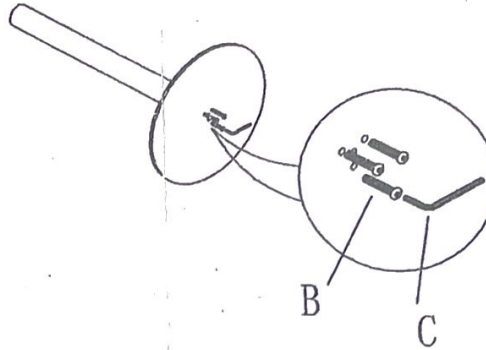

STEP:3

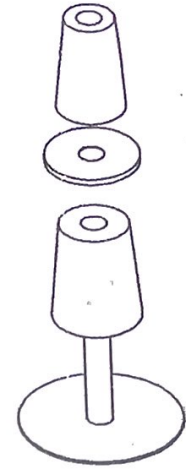

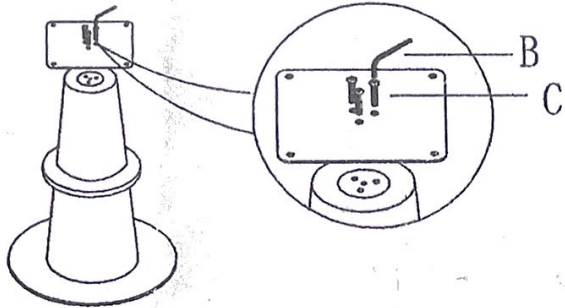

STEP:4

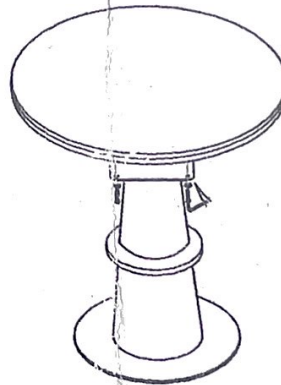

STEP:5



STEP:6

EM NAME:	A: 	B: 	C: 
K1979A	3*35 4PCS	8*25 6PCS	1PC