

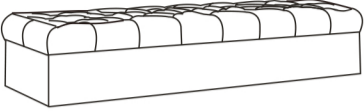





ASSEMBLY INSTRUCTION

Ax1 	Bx2 	Cx4 	
Dx4 	Ex1 	Fx4 	Gx4 

1

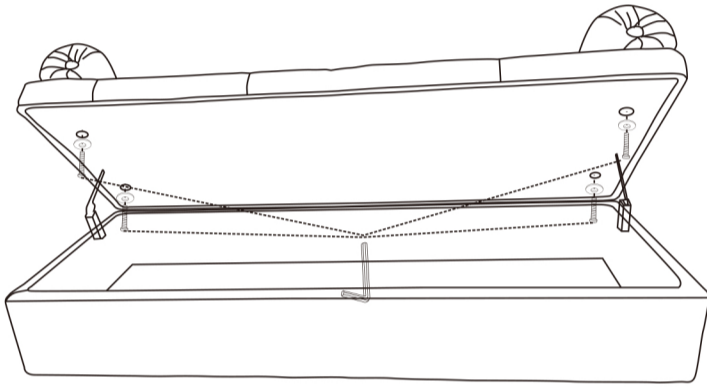

2

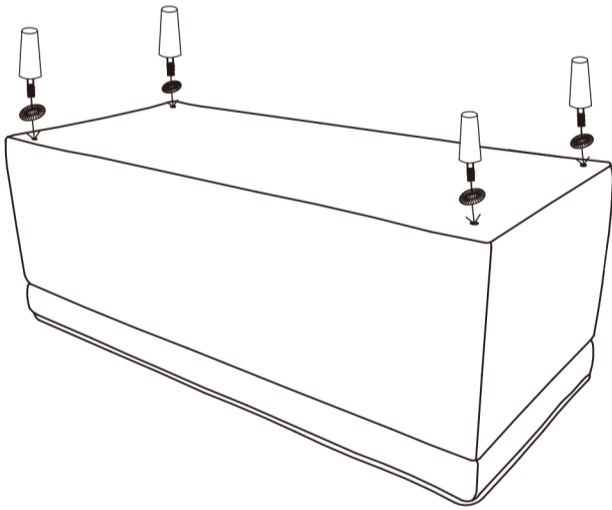

3

