

# LSPU8212S

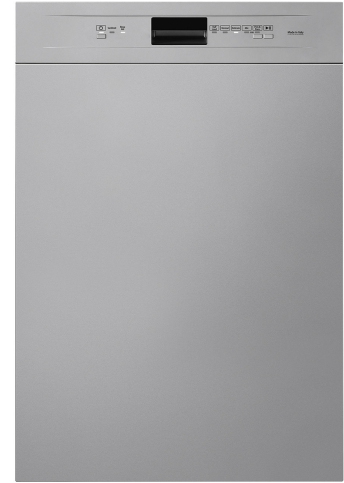

Product family	Dishwashers
Width	24"
Commercial height	82 cm
Installation	Under counter built-in
N° baskets	2
EAN code	8017709303709



## Programs



Number of programs	5	Delicates	Yes
Washing temperatures	45, 50, 65, 70 °F	Normal	Yes
Mix	Yes	Pots & Pans	Yes
Daily (half load)	Yes		

## Options

Professional option	Intensive washing zone option
---------------------	-------------------------------

## Baskets



Basket components finish	Gray	Lower basket	Fixed racks
Upper basket	Central fixed racks	Lower basket with anti-drip inserts	Yes
Glass holder	Yes	Largest loadable dish in lower basket	30,0 inches
Upper basket height adjustment	On two height levels	Colour Inner Components	Blue
Largest loadable dish in upper basket	25,0 inches	Cutlery basket	Yes

## Technical Features



<b>Width</b>	23 9/16 "	<b>Drying system</b>	Natural condensation drying
<b>Depth</b>	22 7/16 "	<b>Tube material</b>	Stainless steel
<b>Height</b>	32 3/16 "	<b>Filter</b>	Stainless steel
<b>Program symbols</b>	Symbols	<b>Concealed heating element</b>	Yes
<b>On/off indicator</b>	Yes	<b>Hinges</b>	Self-balancing with fixed hinges
<b>Rinse aid indicator</b>	Light	<b>Min. and max plinth height</b>	3.9" - 6.6"
<b>End-of-cycle indicator</b>	Light on display, with acoustic signal	<b>Adjustable feet</b>	2 3/4", from 32 1/4" to 35"
<b>Washing system</b>	Standard	<b>Additional gaskets</b>	Yes
<b>Third spray arm</b>	Single	<b>Back cover</b>	Yes
<b>Flood protection system</b>	Single Aquastop	<b>Depth of dishwasher with open door (mm)</b>	1146
<b>Max water hardness</b>	100°FH;58°dH	<b>Top cover</b>	Metal sheet

## Electrical Connection

<b>Plug</b>	(A) USA & Mexico	<b>Frequency (Hz)</b>	60 Hz
<b>Connected power</b>	1800 W	<b>Connection type</b>	Single-phase
<b>Current</b>	10 A	<b>Power supply cable length</b>	140 "
<b>Voltage</b>	110-120 V		

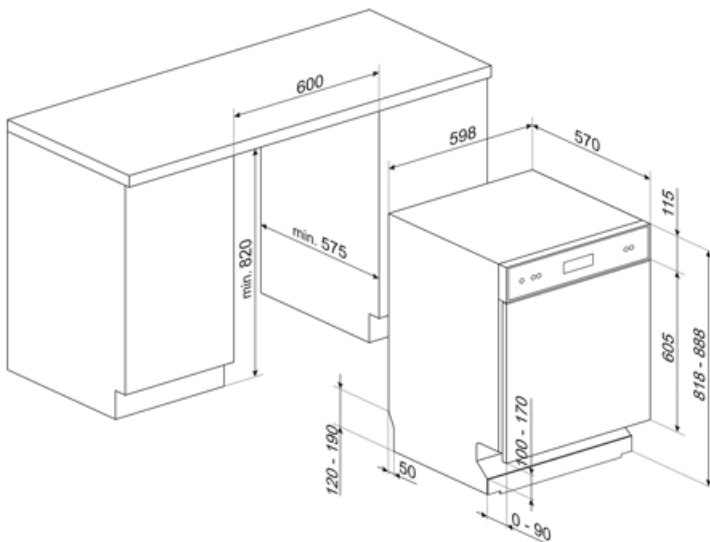

---

## Compatible Accessories

---

### KITPL60FABB



Toe kick Kit in White colour with adjustable height. Can be fitted over all the fully integrated and underbench models with Fixed Fulcrum. Can be installed also on the models with variable fulcrum or flexifit hinges.

### KITPL60FABX



Toe kick Kit in Stainless Steel with adjustable height. Can be fitted over all the fully integrated and underbench models with Fixed Fulcrum. Can be installed also on the models with variable fulcrum or flexifit hinges.

### KITPL60FABN











Toe kick Kit in Black colour with adjustable height. Can be fitted over all the fully integrated and underbench models with Fixed Fulcrum. Can be installed also on the models with variable fulcrum or flexifit hinges.

### KITPLV2



Kit extension for dishwasher and washing machine: lenght mt. 2

## Symbols glossary

	Acquastop: Some Smeg dishwashers are equipped with a simple Acquastop: float sensor in the bottom which is necessary to prevent an accidental leakage of water inside the appliance.		Anti-drip: Some models of dishwashers are equipped with special polymer nozzles anti-drip, that improve the process of drying.
	COMM_HEIGHT_82_72dpi		Noise Level: Excellent insulation and special devices keep noise to a minimum.
	1/2 load: This program is designed for washing dishes not heavily soiled with partial load of the dishwasher.		Delicate: Delicate washing program is designed for delicate dishes which are not heavily soiled.
	Normal programme: The normal programme is suitable for normal degrees of dirt for everyday use.		The symbols show the number of plate settings of the dishwasher.
	System WaterSave ensures the best washing results with minimal water consumption depending on the model of dishwasher.		