

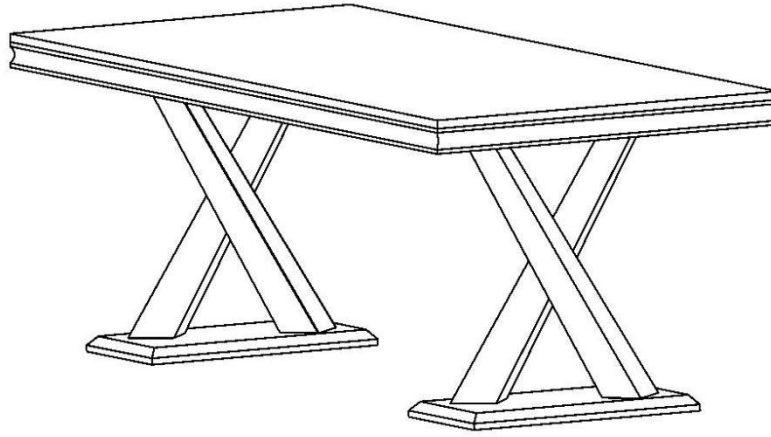

Assembly Instruction

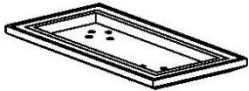

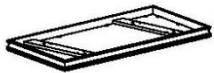



ASSEMBLY TIME PER UNIT: 20 MINUTES

PARTS IDENTIFICATION

A	BASE		2PCS	B	TOP		1PC
C	LEGS		4PCS				

HARDWARE LIST

NO.	SIZE	DIAGRAM	QTY	NO.	SIZE	DIAGRAM	QTY
1	Allen wrench		1	3	Bolts M8x16		12
2	Bolts M8x40		16	4	Flat washer		28

Dining Table

Notice: Please be sure to follow the assembly instruction.

STEP1

tighten all the screws to 50%.

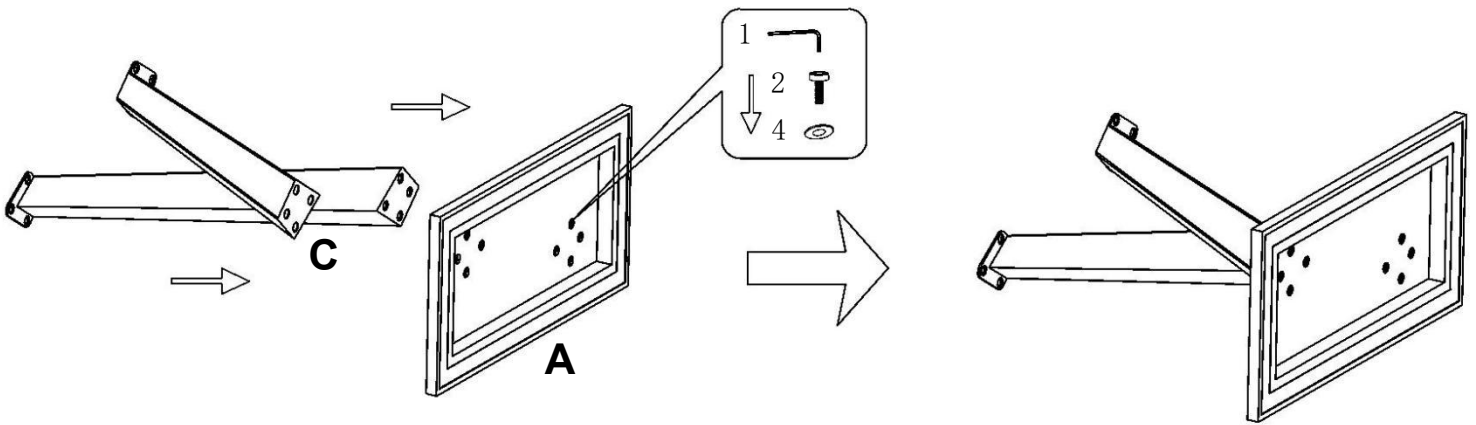

STEP2

tighten all the screws to 50%.

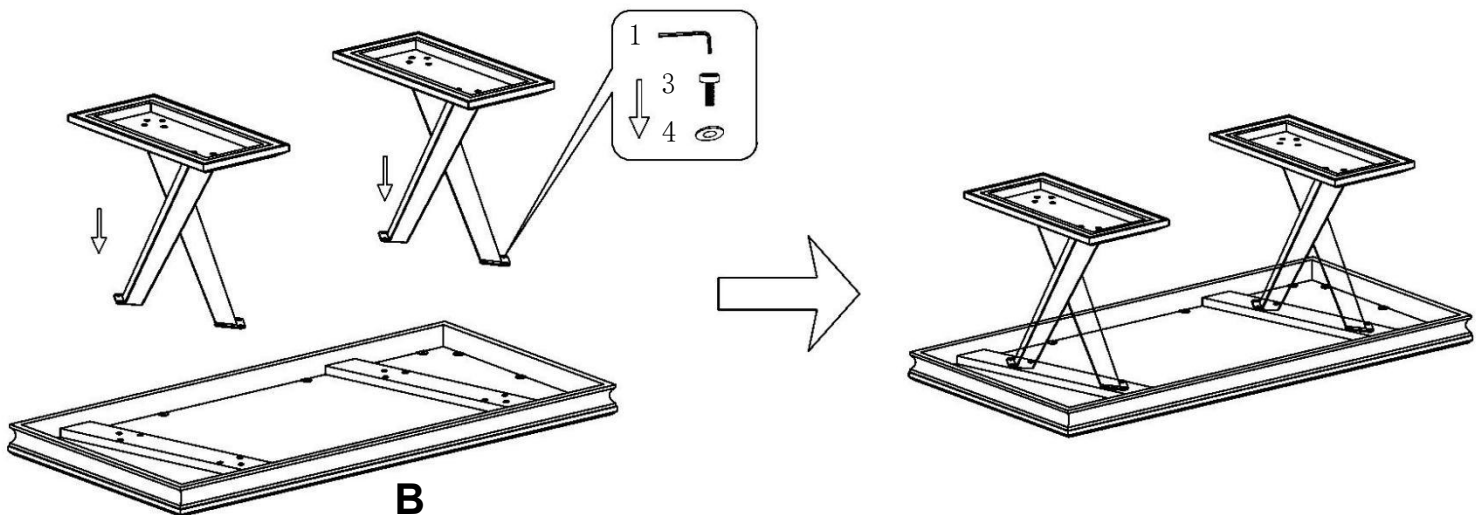

STEP3

After fixed all screws then 100% tighten.

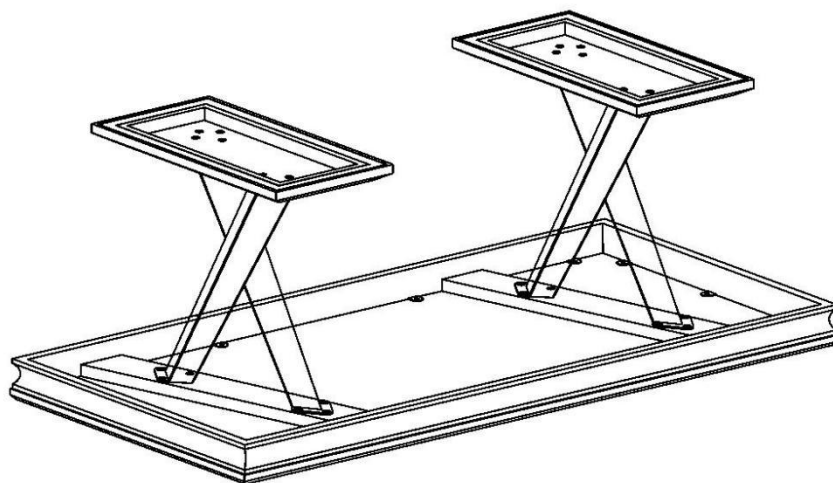

COMPLETED

