

INSTRUCTION MANUAL



Contact Information

Question about your product? We're here to help. Contact us by:



Orders FAQ



Product Assembly



Product Inquiry



Chat Support



Returns & Refunds

If you have any problems, please send your order number and photos to us.
We will contact you within 24 hours and provide you with a satisfactory solution.

! NOTICE Please retain these instructions for future reference.

- Carefully unpack all the components and verify that all the necessary parts are included as listed in the packaging.
- Identify each component and refer to the provided assembly diagram or step-by-step instructions.
- Assemble the furniture in the order specified to ensure proper alignment and fit.
- Use the provided tools or recommended tools for assembly. Do not use excessive force when tightening screws or bolts.
- If any difficulties arise during assembly. Consult the troubleshooting section or contact our customer support.



ASSEMBLY INSTRUCTIONS

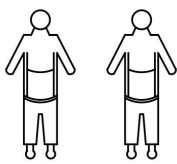

2 people

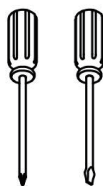



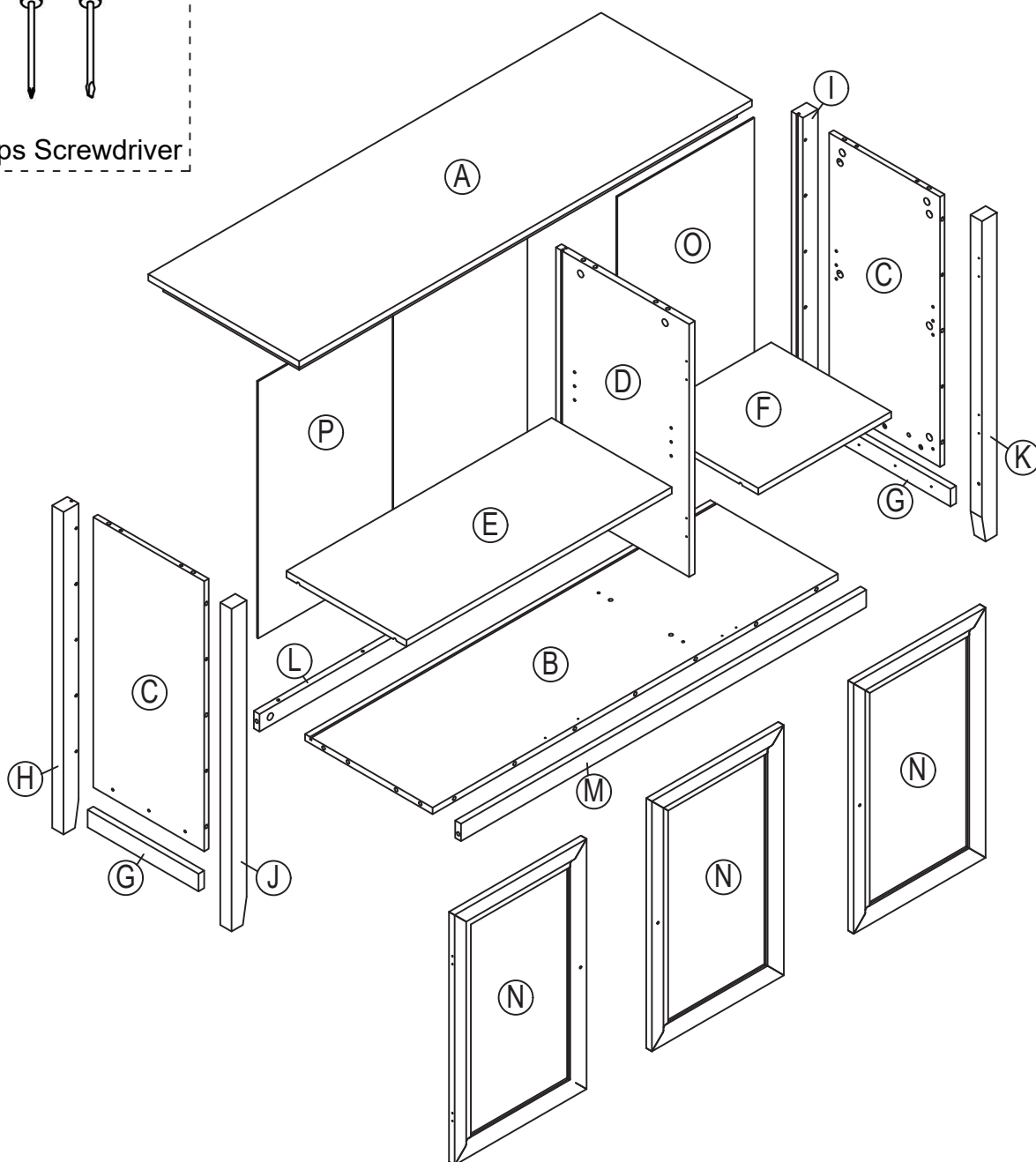





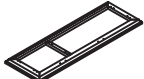

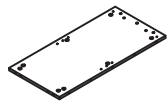
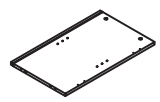

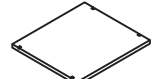

Phillips Screwdriver







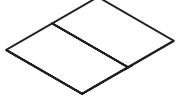









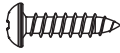





PARTS LIST

- | | | | | | |
|---|--|---|--|--|--|
| A
Top Panel

1 PC | B
Bottom Panel

1 PC | C
Side Panel

2 PCS | D
Middle Vertical Divider

1 PC | E
Middle Shelf

1 PC | F
Middle Shelf

1 PC |
| G
Side Panel Left and Right Support Bar

2 PCS | H
Left Rear Leg

1 PC | I
Right Rear Leg

1 PC | J
Left Front Leg

1 PC | K
Right Front Leg

1 PC | L
Bottom Panel Rear Support Bar

1 PC |
| M
Front Crossbar for the Bottom Panel

1 PC | N
Door

3 PCS | O
Back Panel

1 PC | P
Back Panel

1 PC | | |



HARDWARE LIST

01 Ø15X9.5mm Cam Lock  31+3 PCS	02 Ø6.5X35mm Cam Bolt  31+3 PCS	03 Ø6X30mm Wooden Dowel  12+1 PCS	04 Ø8X30mm Wooden Dowel  10+1 PCS	05 Ø3X14mm Screw  8+1 PCS	06 Ø3X14mm Screw  30+3 PCS
07 Ø4X20mm Screw  6+1 PCS	08 Ø4X35mm Screw  7+1 PCS	09 M4X16mm Screw  3+1 PCS	10 31X31X26mm Handle  3 PCS	11 66X25X7mm Hinge  6 PCS	12 45X15X14mm Magnetic Door Catch  2 PCS
13 96X20X14mm Magnetic Door Catch  2 PCS	14 26X22mm Iron Sheet  6 PCS	15 Ø5X16mm Shelf Support  8 PCS	16 Ø3X14mm Back Panel Buckle  16+1 PCS	17 Ø21mm Screw Hole Sticker  18+1 PCS	18 Anti-Tipping Device  2 PCS



If you are missing any parts, please provide your order number and circle the part number. Send us a photo of this, and we will provide you with a satisfactory solution. Thank you.

STEP 1

Please tighten the screws after completing all installation.

Por favor, apriete los tornillos después de instalar todo.

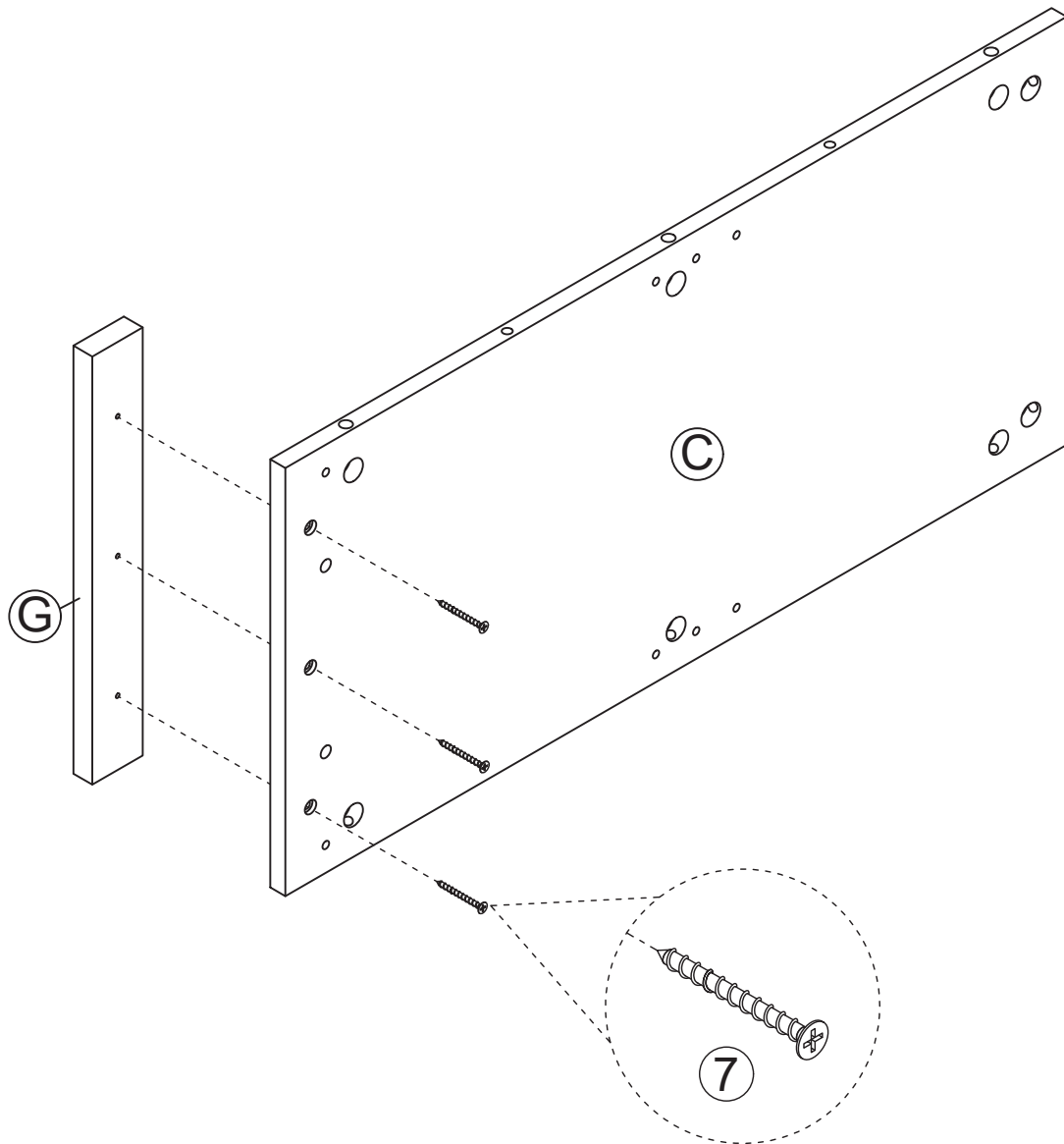
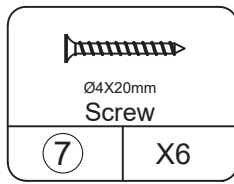
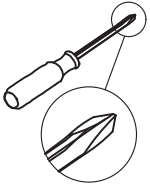

X2

STEP 2

Please tighten the screws after completing all installation.

Por favor, apriete los tornillos después de instalar todo.

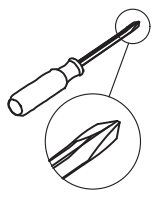

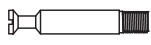
	
Ø6.5X35mm Cam Bolt	
2	X12

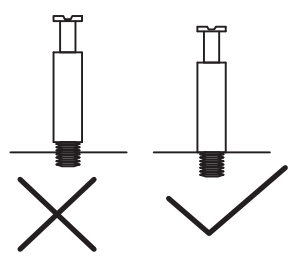
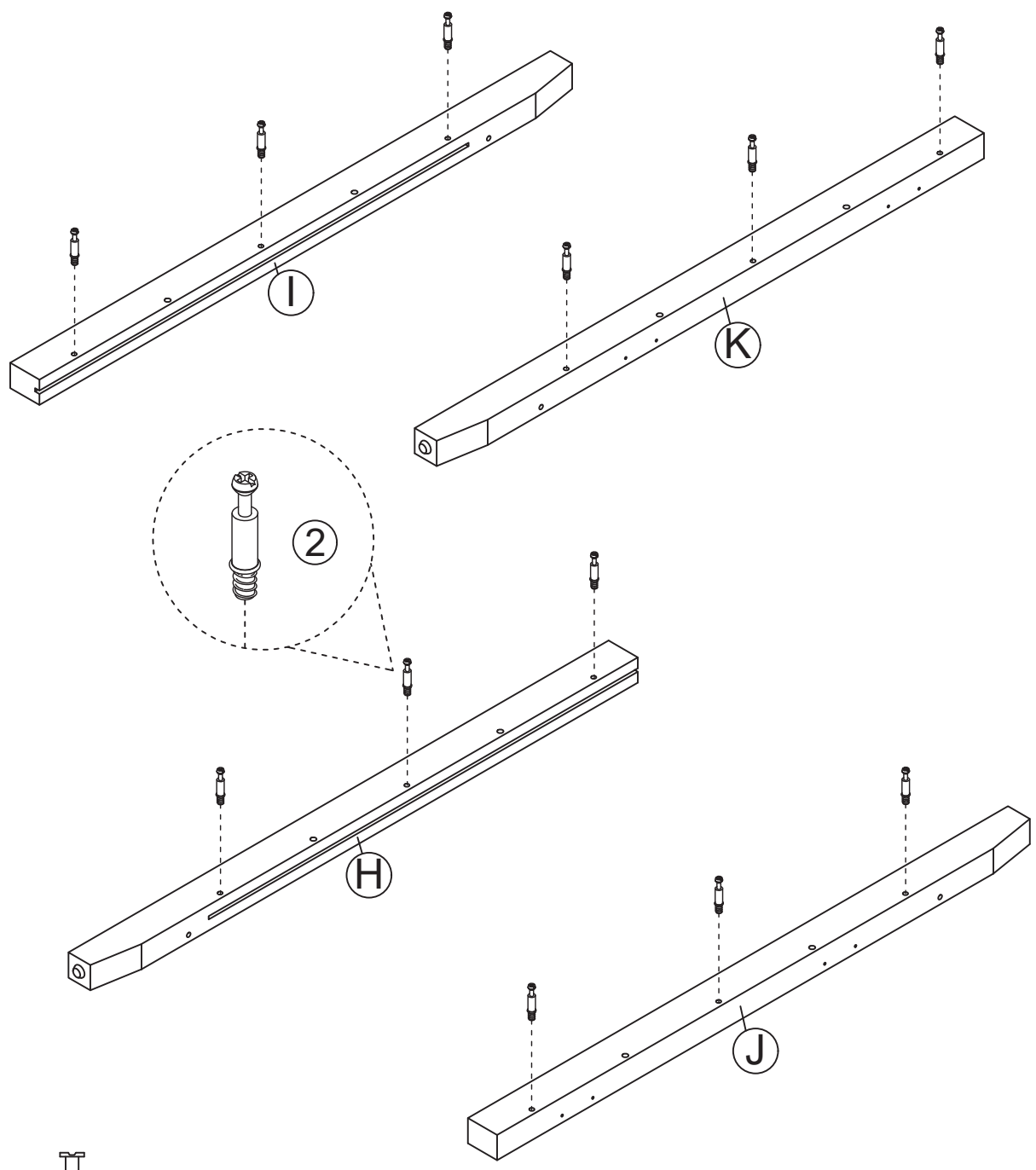

STEP 3

Please tighten the screws after completing all installation.

Por favor, apriete los tornillos después de instalar todo.

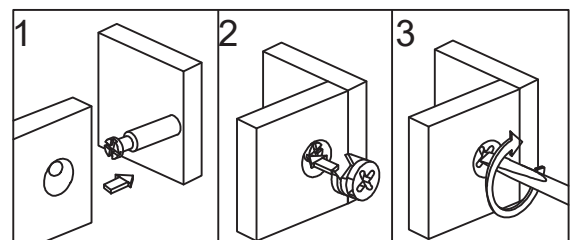
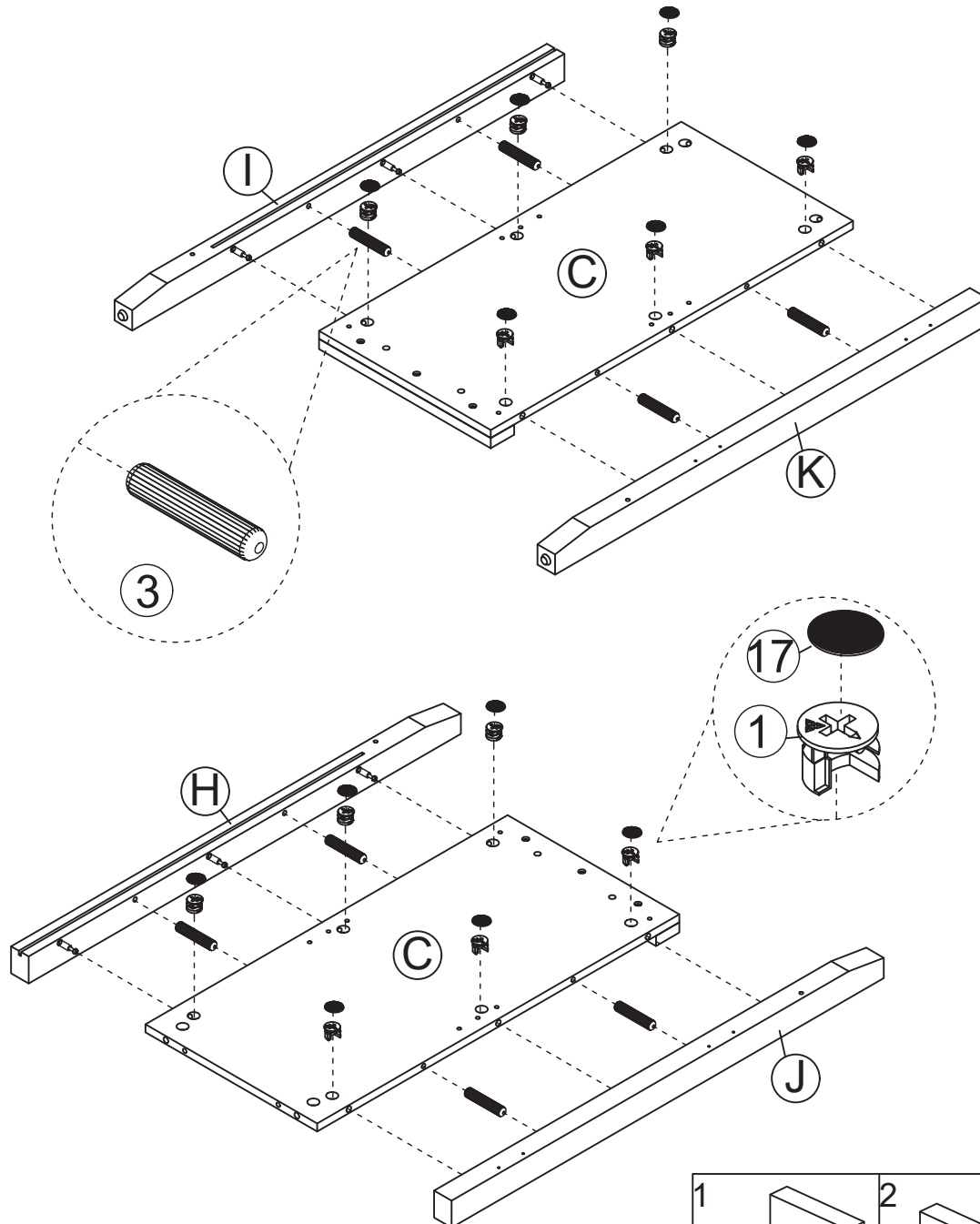
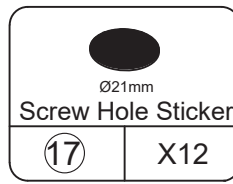
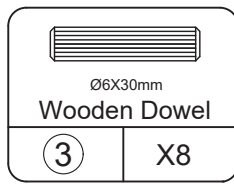
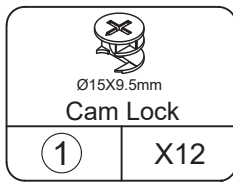
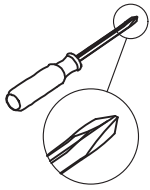

STEP 4

Please tighten the screws after completing all installation.

Por favor, apriete los tornillos después de instalar todo.

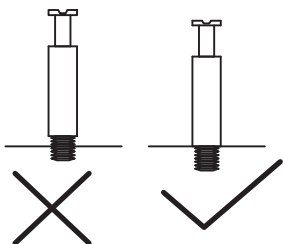
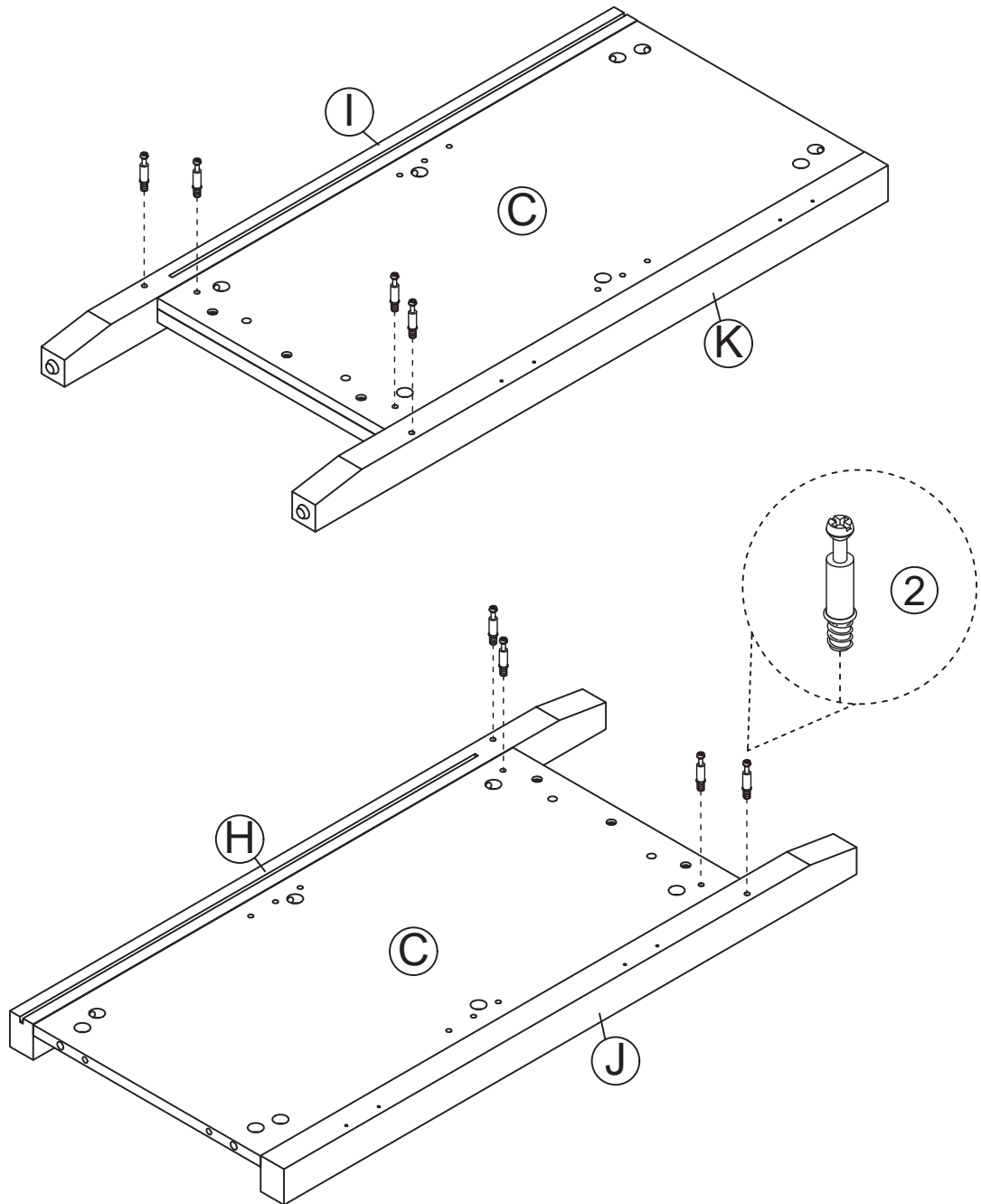
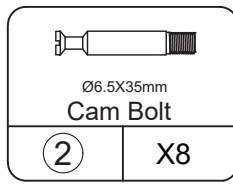
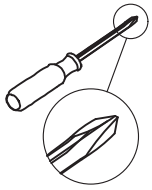

STEP 5

Please tighten the screws after completing all installation.

Por favor, apriete los tornillos después de instalar todo.

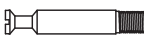

 Ø15X9.5mm Cam Lock	
1	X5

 Ø6.5X35mm Cam Bolt	
2	X5

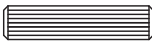
 Ø8X30mm Wooden Dowel	
4	X2

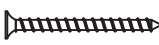
 Ø4X35mm Screw	
8	X5

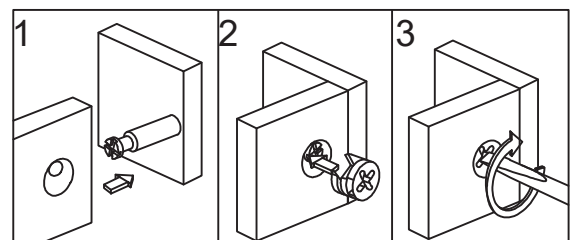
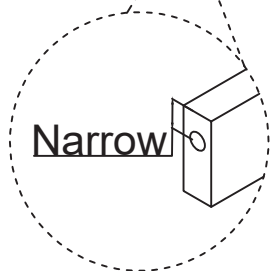
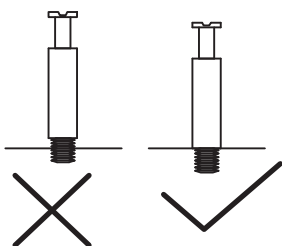
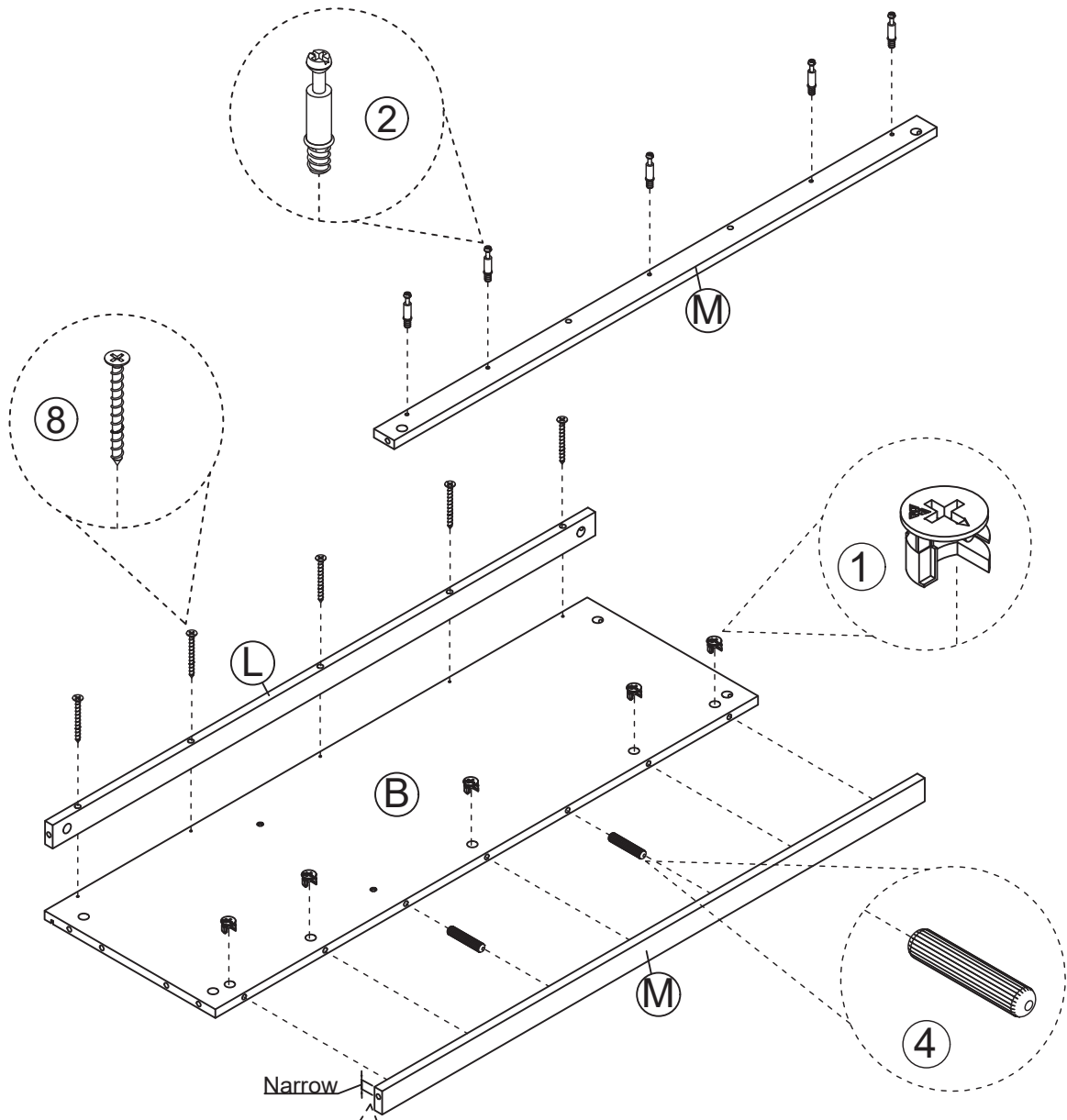

STEP 6

Please tighten the screws after completing all installation.

Por favor, apriete los tornillos después de instalar todo.

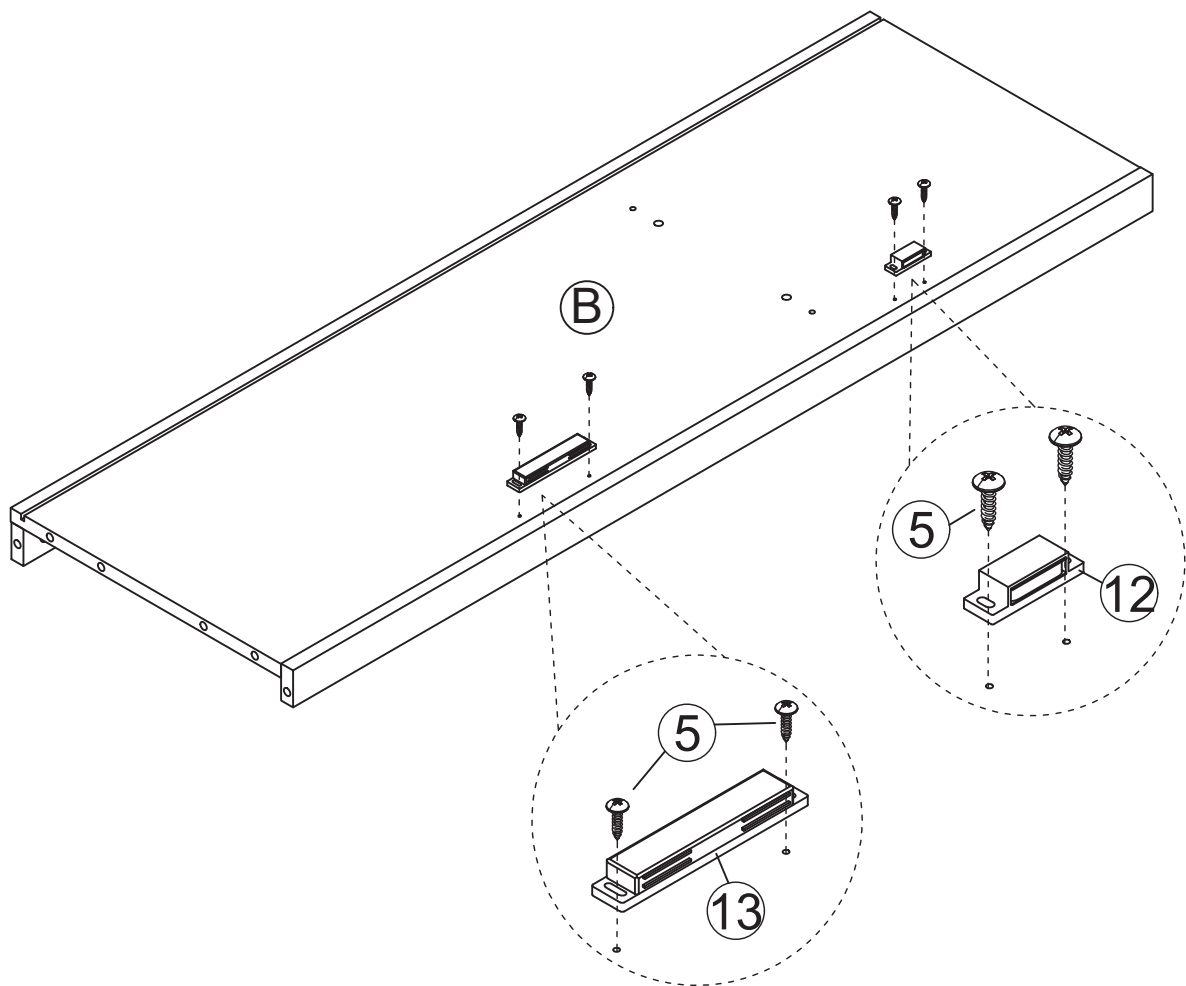
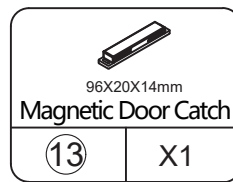
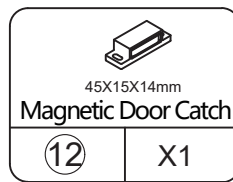
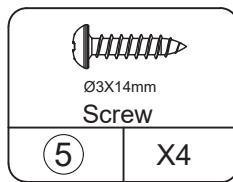
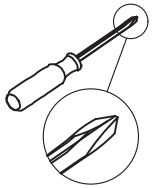

STEP 7

Please tighten the screws after completing all installation.

Por favor, apriete los tornillos después de instalar todo.

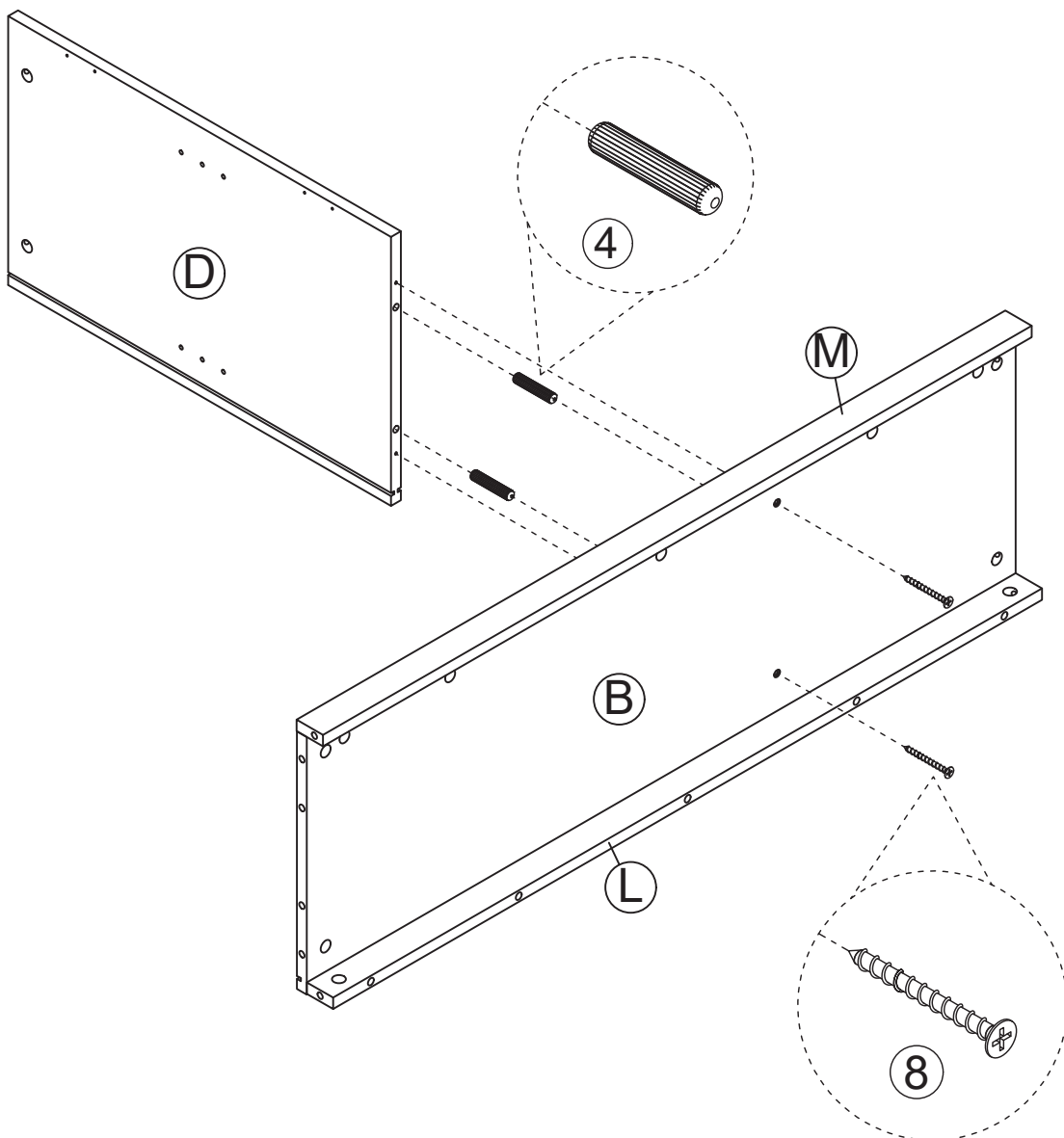
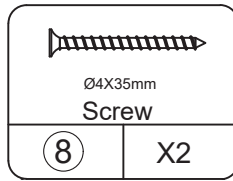
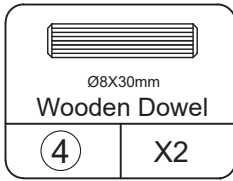
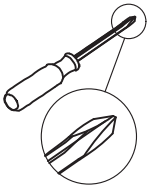

STEP 8

Please tighten the screws after completing all installation.

Por favor, apriete los tornillos después de instalar todo.

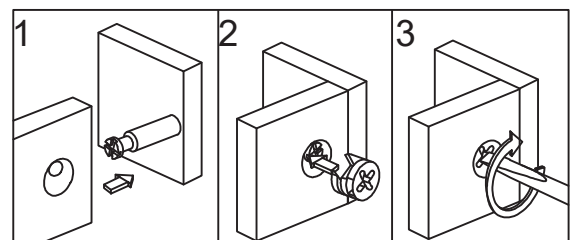
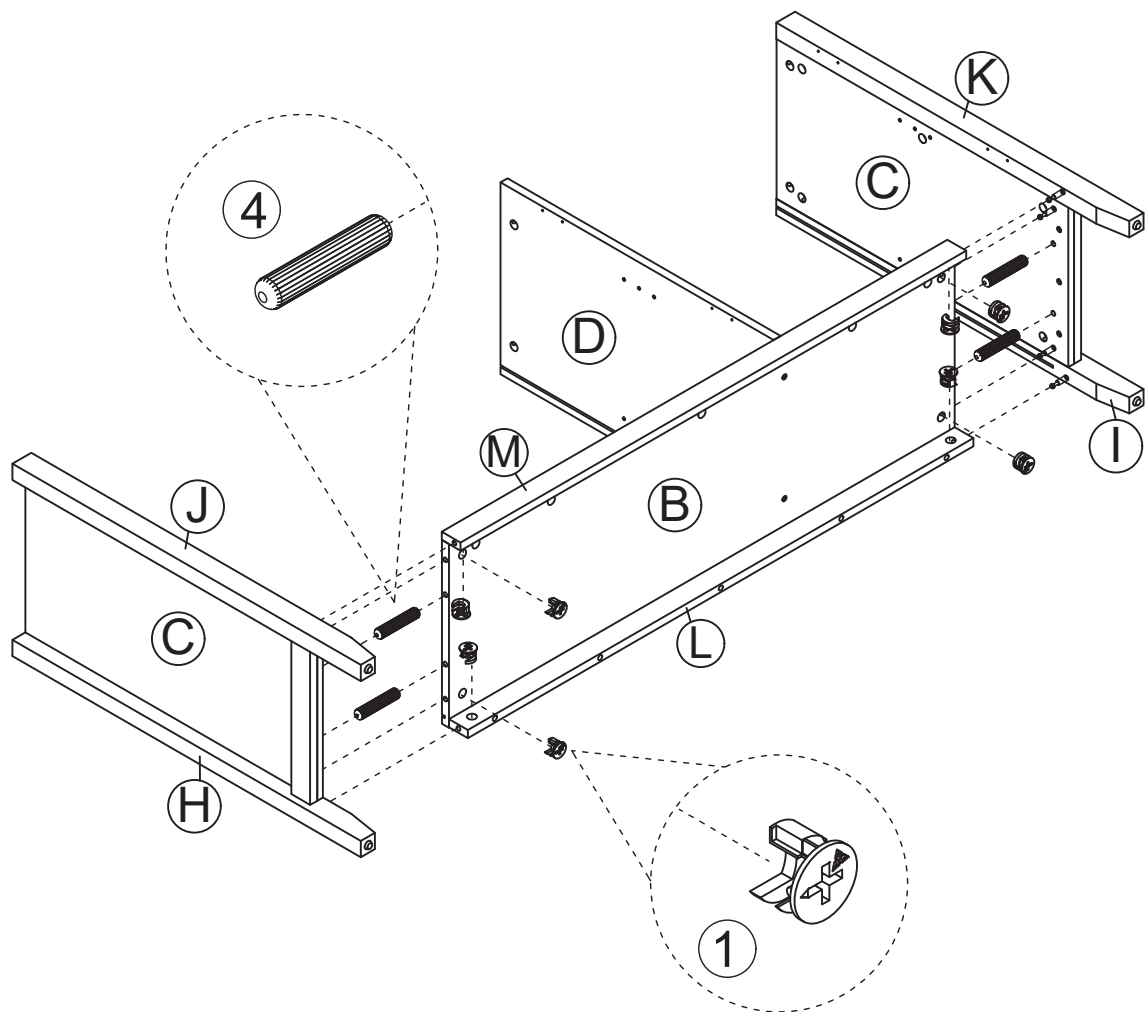
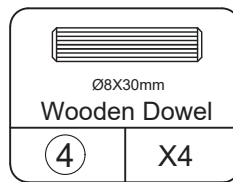
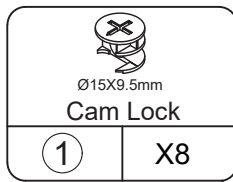
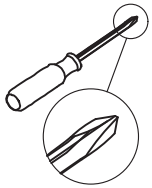

STEP 9

Please tighten the screws after completing all installation.

Por favor, apriete los tornillos después de instalar todo.

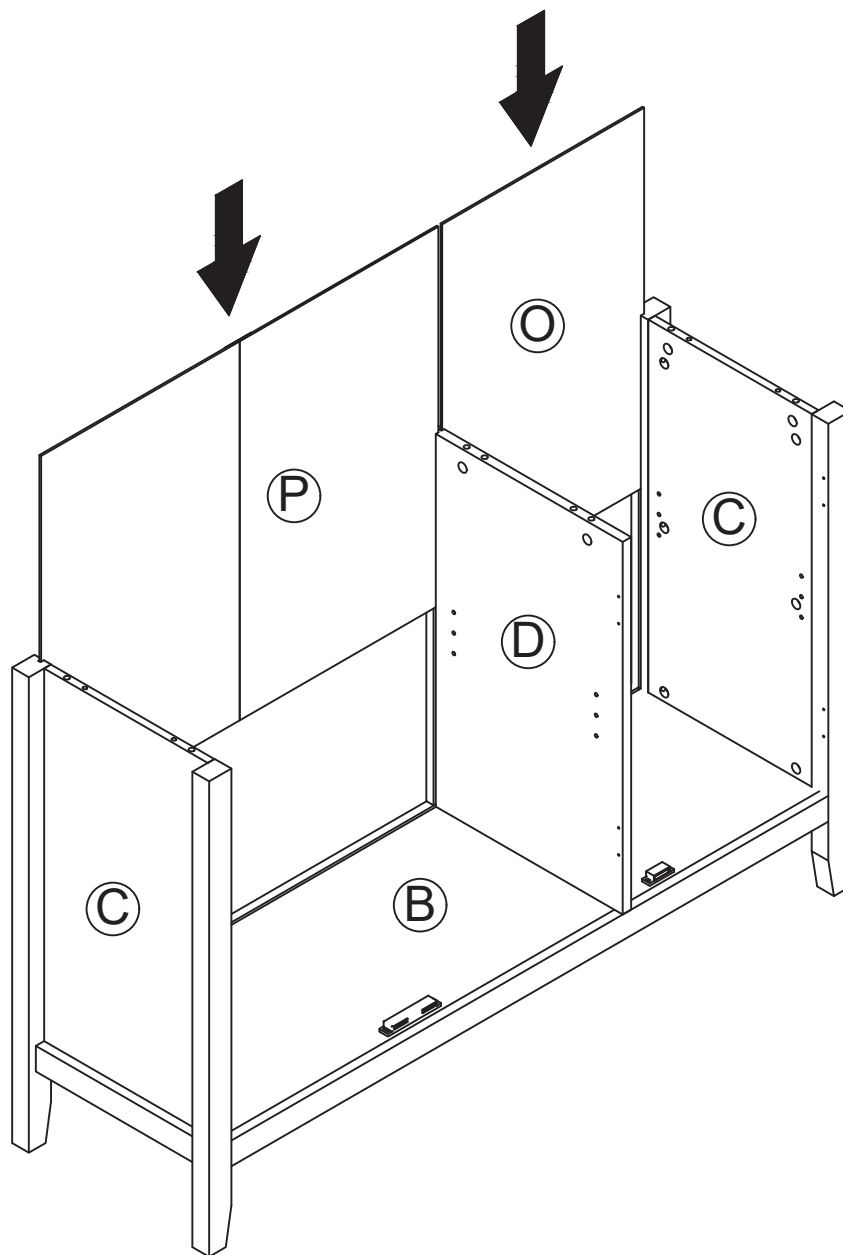

STEP 10

Please tighten the screws after completing all installation.

Por favor, apriete los tornillos después de instalar todo.

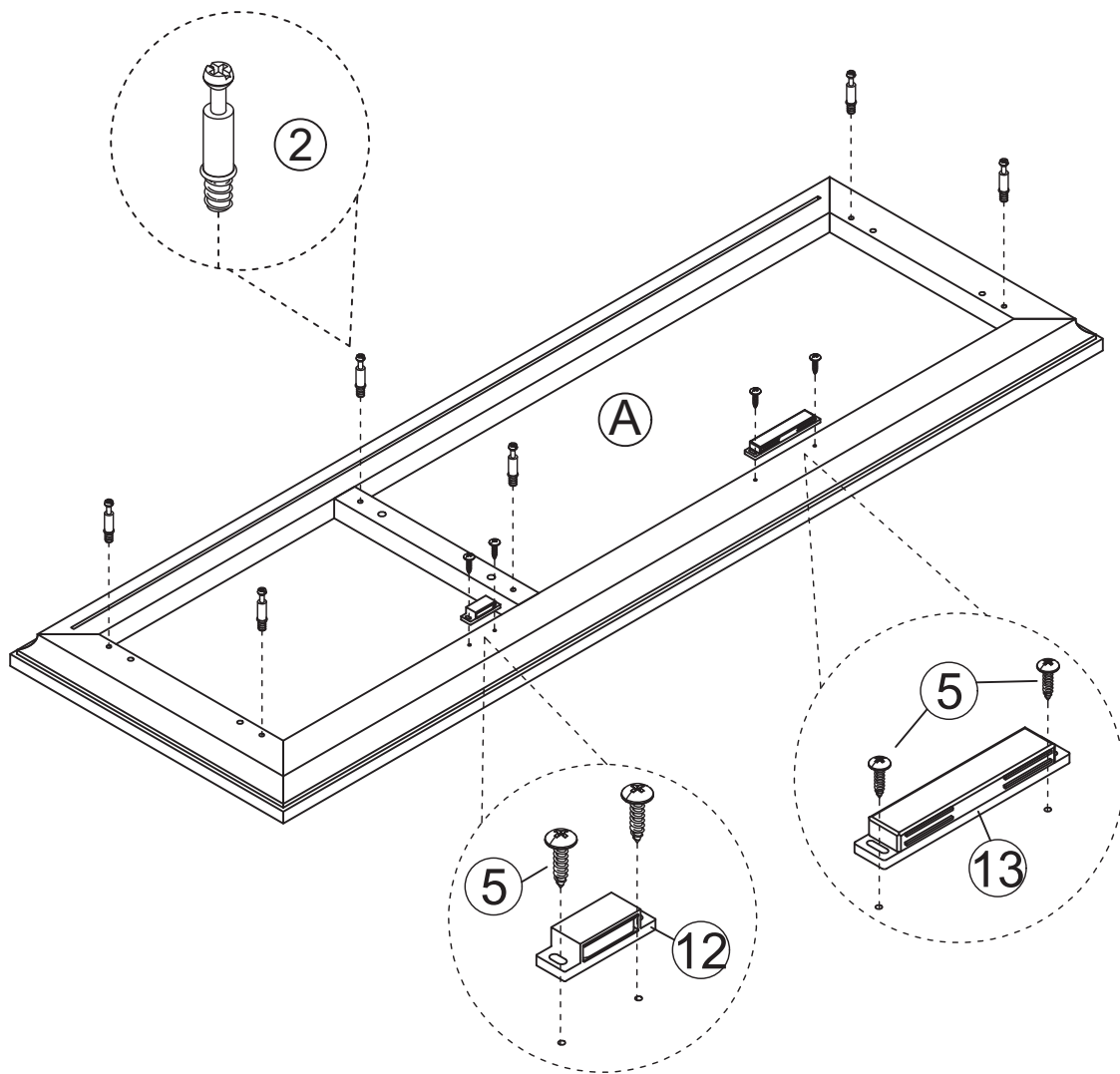
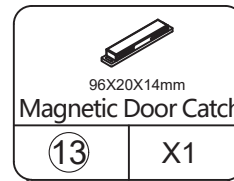
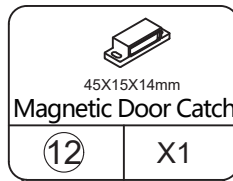
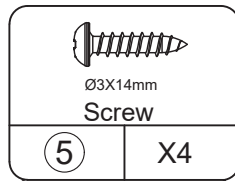
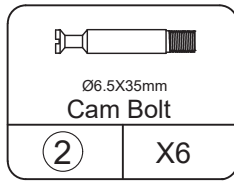
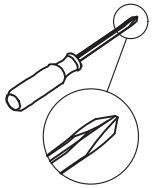

STEP 11

Please tighten the screws after completing all installation.

Por favor, apriete los tornillos después de instalar todo.

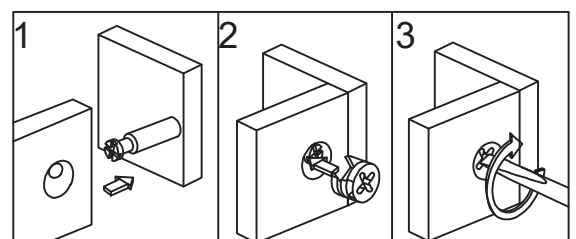
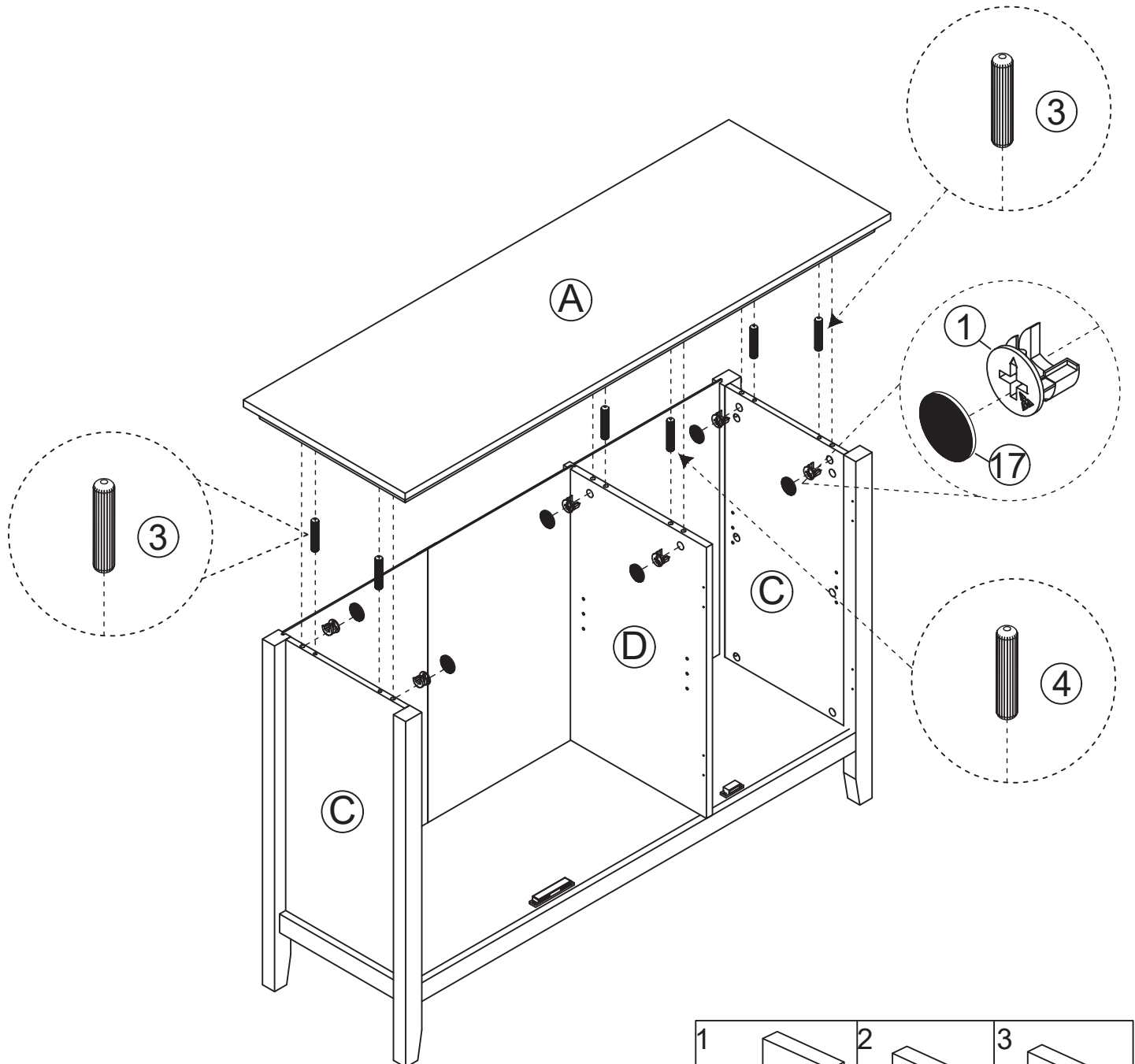
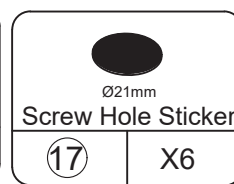
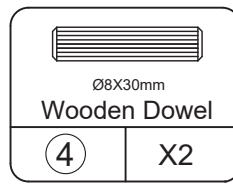
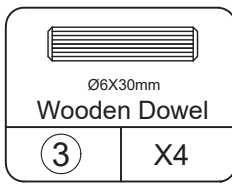
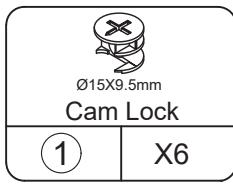
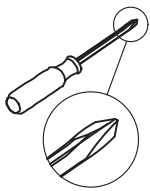



STEP 12

Please tighten the screws after completing all installation.

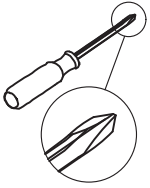
Por favor, apriete los tornillos después de instalar todo.



 Ø3X14mm Screw	
6	X18

 66X25X7mm Hinge	
11	X6

 26X22mm Iron Sheet	
14	X6

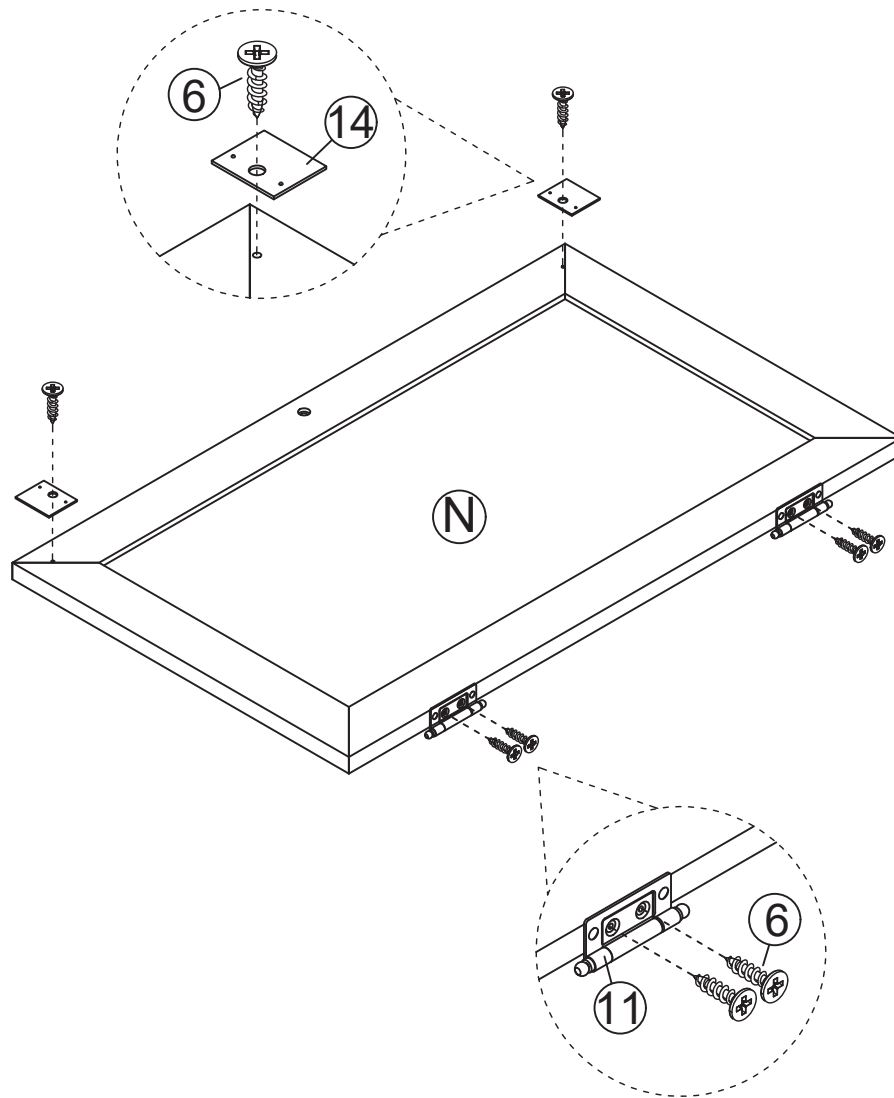

X3

STEP 13

Please tighten the screws after completing all installation.

Por favor, apriete los tornillos después de instalar todo.

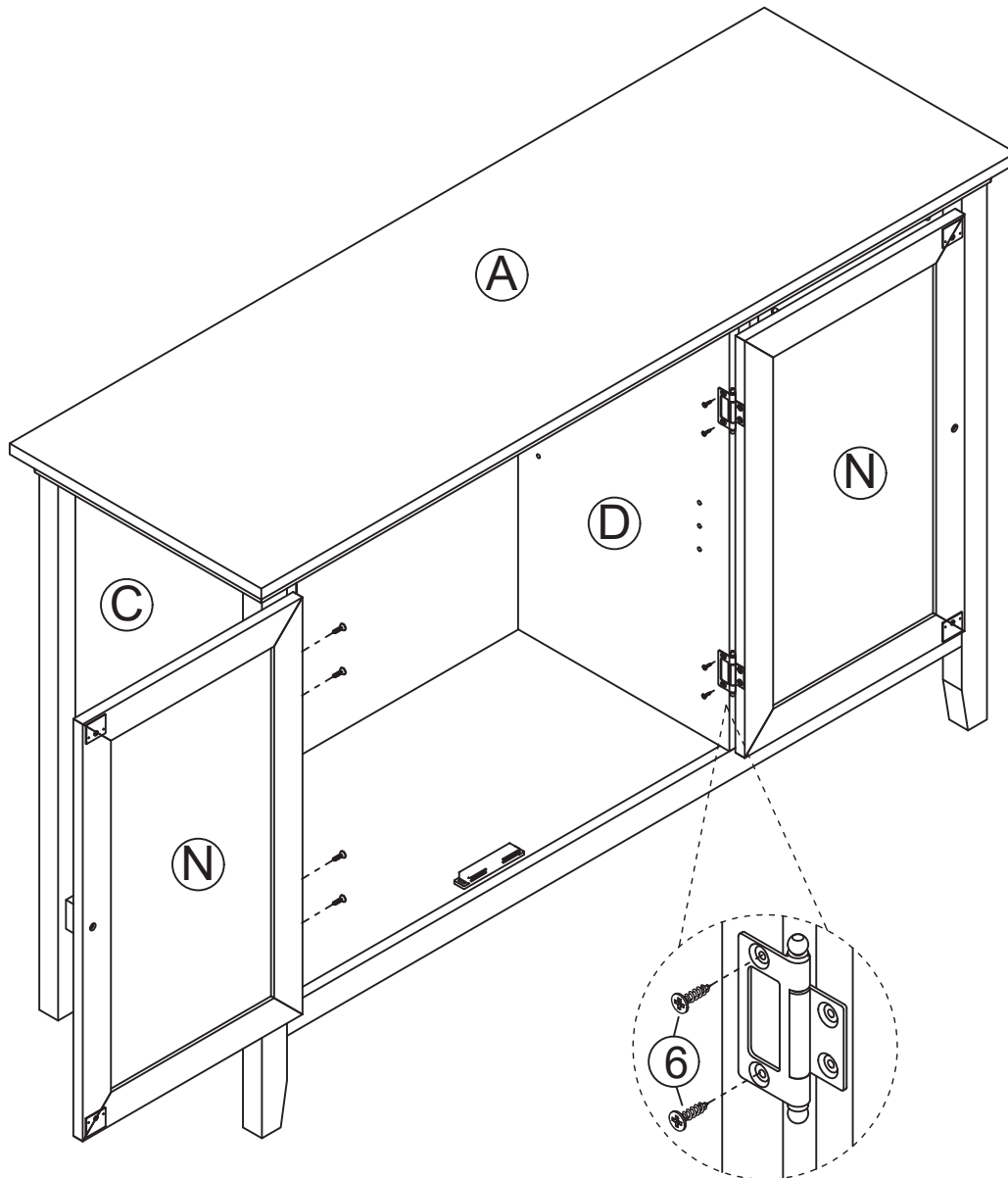
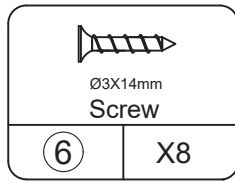
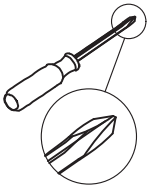

STEP 14

Please tighten the screws after completing all installation.

Por favor, apriete los tornillos después de instalar todo.

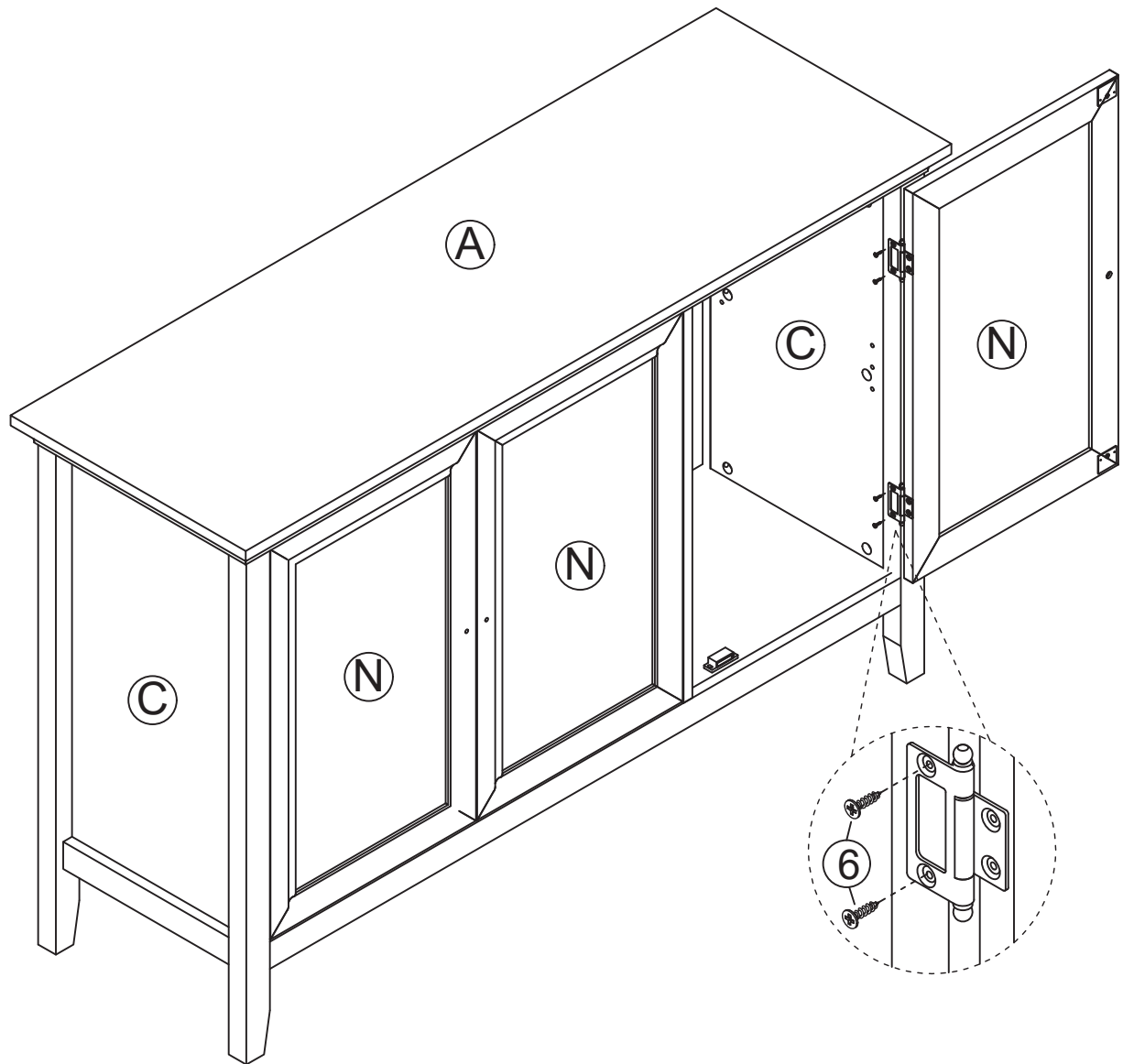
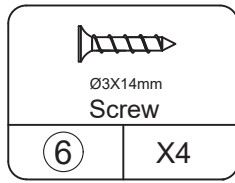
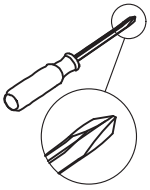

STEP 15

Please tighten the screws after completing all installation.

Por favor, apriete los tornillos después de instalar todo.

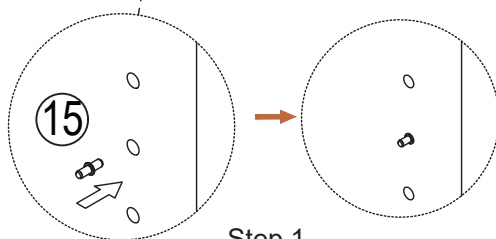
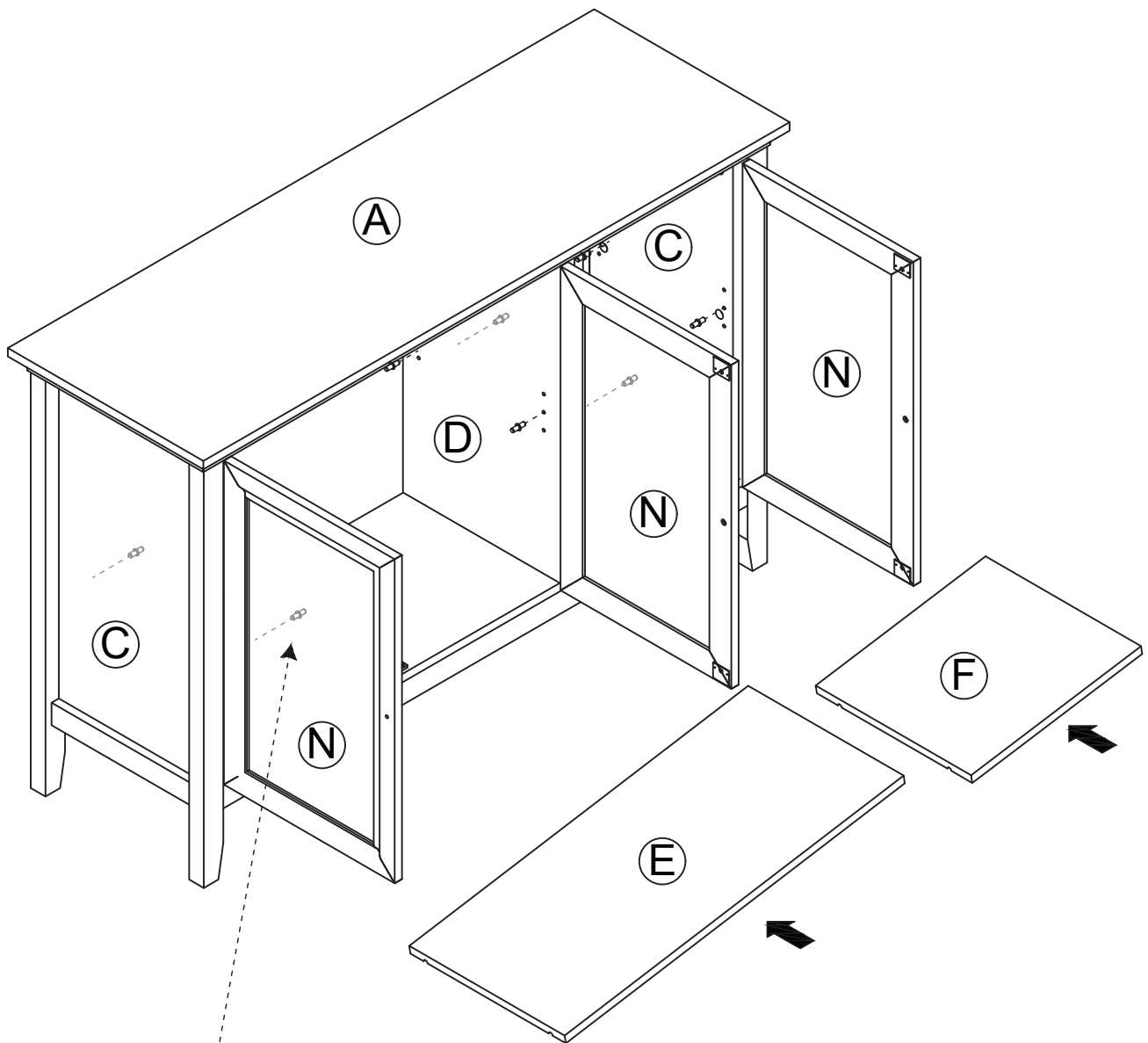
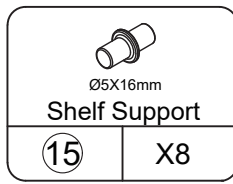
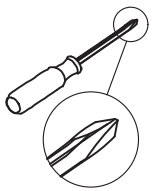

Step 1
Select the desired height and put it in.

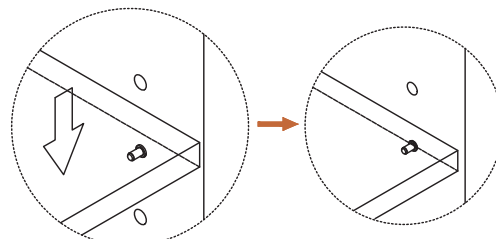

Step 2
Aim the board gaps down.

STEP 16

Please tighten the screws after completing all installation.

Por favor, apriete los tornillos después de instalar todo.

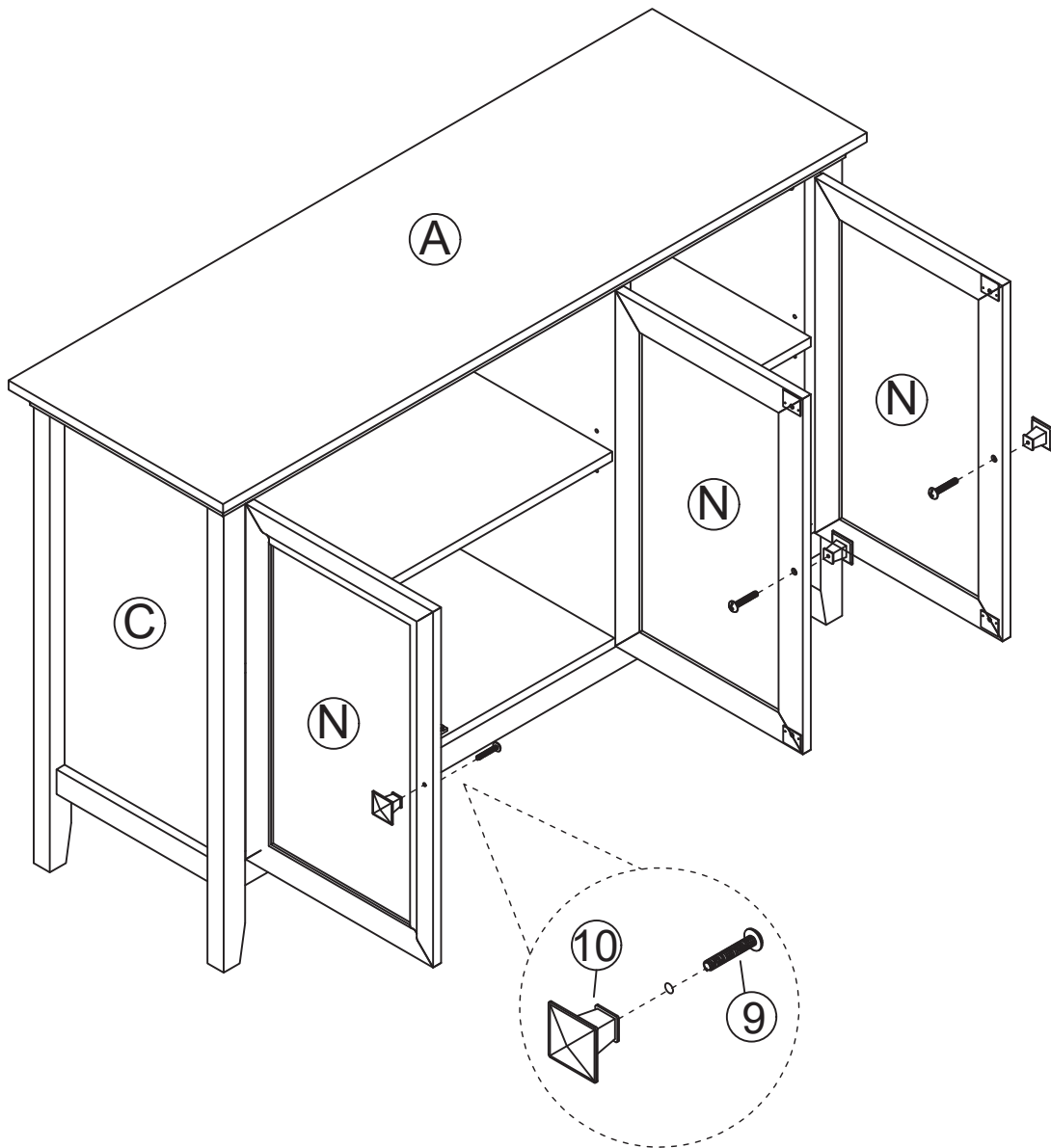
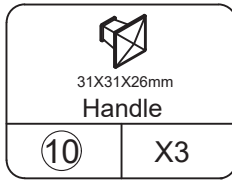
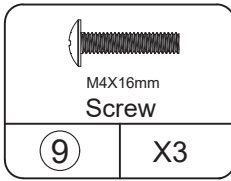
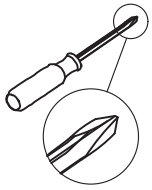

STEP 17

Please tighten the screws after completing all installation.

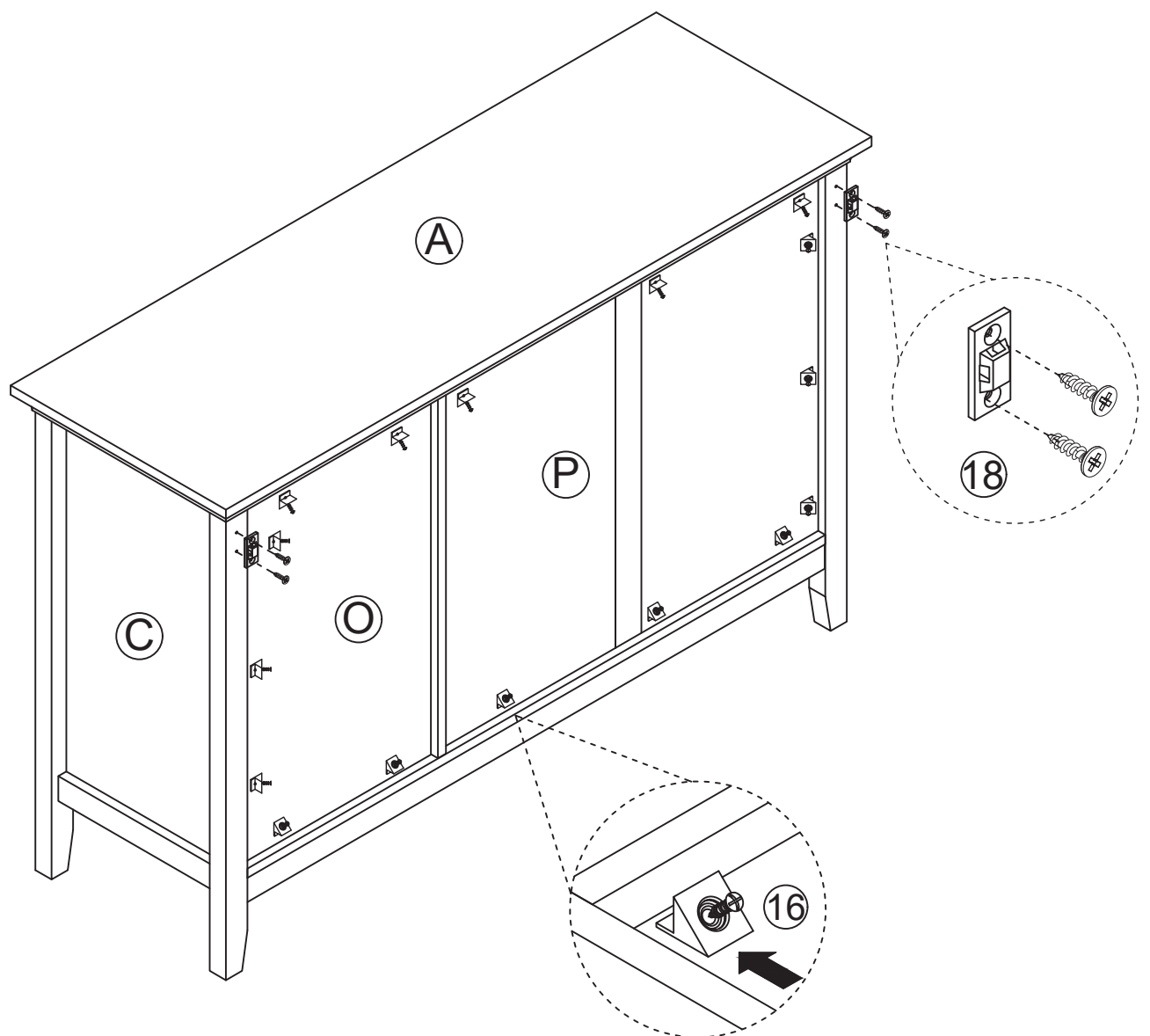
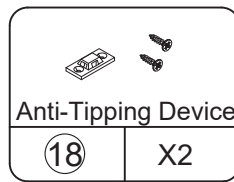
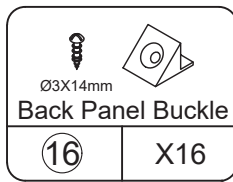
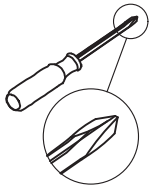



Insert the plastic buckle into the slot on the back plate. Then, screw through the hole in the plastic buckle to secure it in place.

STEP 18

Please tighten the screws after completing all installation.

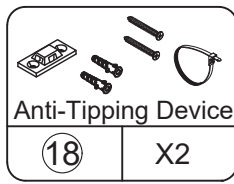
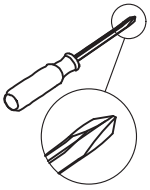
Por favor, apriete los tornillos después de instalar todo.



NOTE: The included tipping restraint hardware is designed for wooden stud wall construction and must be attached to a wall stud. Depending on your wall construction, different anchor hardware may be required. Please contact your local hardware store for assistance. Furniture tipping can cause serious injury to young children. It is essential to install the tipping restraint hardware to prevent accidents or damage.  The tipping restraints are intended only as a deterrent and are not a substitute for proper adult supervision. These restraints are not designed for earthquake safety. If you wish to add earthquake restraints, they must be purchased and installed separately.

Install the Tipping Restraint Hardware

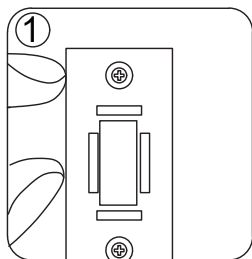

1. Make marks on the wall

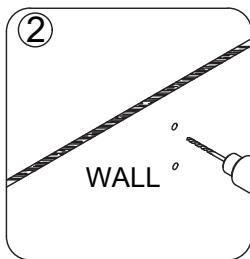

2. Drill two Ø6 holes on the wall

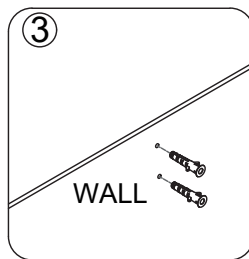

3. Put two anchors in the holes

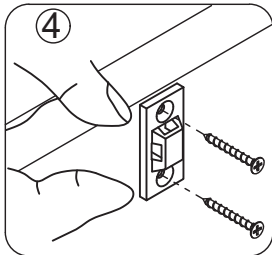

4. Fix the device on the wall using the long screws

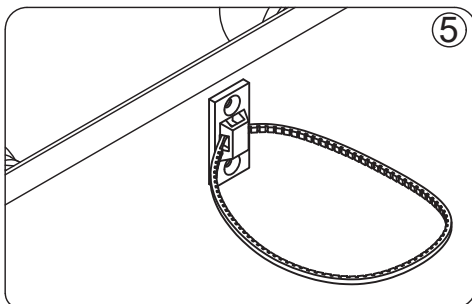

5. Push the cabinet close to the wall, aligning its base with the wall, and then use a nylon tie to secure it.

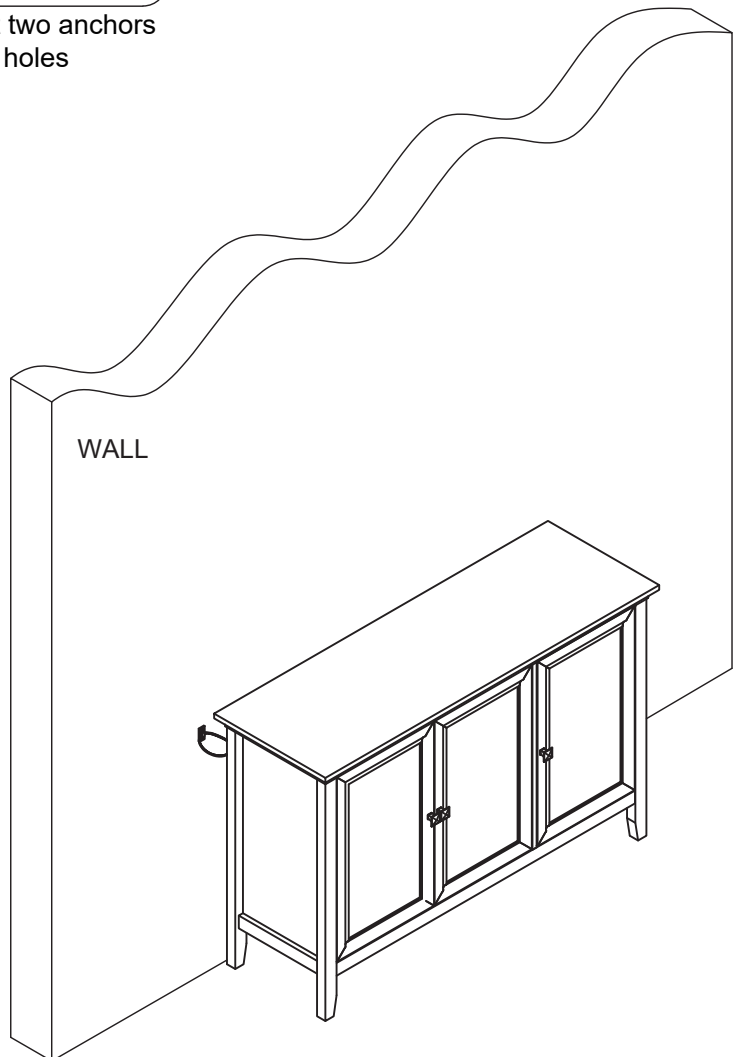



MAINTENANCE AND CARE

Prevent Moisture Damage:

Safeguard your laminate furniture by keeping it in a dry environment. Store the furniture away from damp areas and water sources.

Sunlight Shielding:

Shield your laminate furniture from direct sunlight to prevent color fading and surface deterioration. Consider using curtains or blinds for protection, especially if direct sunlight exposure is unavoidable.

Regular Care:

Maintain your laminate furniture's appearance by gently wiping surfaces with a damp cloth. Avoid using overly wet cloths or abrasive cleaning tools.

Avoid Scratches:

Protect the furniture surface from scratches by refraining from placing sharp or hard objects on it. When moving the furniture, be cautious not to scrape the legs against the floor.

Proper Weight Distribution:

Prevent structural damage by placing heavy objects on stable support surfaces rather than directly on the laminate furniture's surface. This simple step can prolong the life of your furniture.



WARRANTY INFORMATION

Warranty Coverage: Our warranty provides protection against manufacturing defects in materials and workmanship for a specified period from the date of purchase, as outlined in the accompanying warranty documentation.

Exclusions: The warranty does not cover damages resulting from misuse, negligence, accidents, normal wear and tear, unauthorized repairs or modifications, improper assembly, or failure to adhere to the care and maintenance guidelines provided.

WARRANTY CLAIM PROCESS

To initiate a return, please follow these steps:

1. Log into your account and go to the "Your Orders" section.
2. Locate the order containing the item you wish to return.
3. Contact our customer service for assistance in obtaining a prepaid return label.
4. Once you receive the return label, securely affix it to the package.
5. You can then choose to drop off the package at a designated carrier location or arrange for a pickup.
6. After we receive and inspect the returned product, we will initiate the refund process.
7. The refund will be credited back to the original payment method used during the purchase.
8. Typically, refunds are processed within 3-5 business days.



MANTENIMIENTO Y CUIDADO

Evite daños por humedad:

Proteja sus muebles laminados manteniéndolos en un ambiente seco. Guarde los muebles lejos de zonas húmedas y fuentes de agua.

Protéjalos de la luz solar:

Proteja sus muebles laminados de la luz solar directa para evitar la pérdida de color y el deterioro de la superficie. Considere el uso de cortinas o persianas como protección, especialmente si la exposición directa a la luz solar es inevitable.

Cuidado regular:

Mantenga el aspecto de sus muebles laminados limpiando suavemente las superficies con un paño húmedo. Evite utilizar paños demasiado húmedos o herramientas de limpieza abrasivas.

Evite los arañazos:

Proteja la superficie del mueble de arañazos evitando colocar objetos afilados o duros sobre ella. Al mover el mueble, tenga cuidado de no raspar las patas contra el suelo.

Distribución adecuada del peso:

Evite daños estructurales colocando objetos pesados sobre superficies de apoyo estables en lugar de directamente sobre la superficie del mueble laminado. Este sencillo paso puede prolongar la vida de sus muebles.



INFORMACIÓN SOBRE LA GARANTÍA

Cobertura de la garantía: Nuestra garantía proporciona protección contra defectos de fabricación en materiales y mano de obra durante un período determinado a partir de la fecha de compra, como se indica en la documentación de garantía adjunta.

Exclusiones: La garantía no cubre los daños resultantes de uso indebido, negligencia, accidentes, desgaste normal, reparaciones o modificaciones no autorizadas, montaje incorrecto o incumplimiento de las directrices de cuidado y mantenimiento proporcionadas. Las directrices de cuidado y mantenimiento proporcionadas.

PROCESO DE RECLAMACIÓN DE LA GARANTÍA

Para iniciar una devolución, siga estos pasos:

1. Accede a tu cuenta y ve a la sección "Tus pedidos".
2. Localiza el pedido que contiene el artículo que deseas devolver.
3. Ponte en contacto con nuestro servicio de atención al cliente para que te ayuden a obtener una etiqueta de devolución prepagada.
4. Una vez que reciba la etiqueta de devolución, fíjela firmemente al paquete.
5. A continuación, puede optar por depositar el paquete en el lugar designado por el transportista o solicitar que lo recojan.
6. Después de que recibamos e inspeccionemos el producto devuelto, iniciaremos el proceso de reembolso.
7. El reembolso se abonará de nuevo al método de pago original utilizado durante la compra.
8. Normalmente, los reembolsos se procesan en un plazo de 3 a 5 días laborables.