

ASSEMBLY INSTRUCTIONS FOR BED

AX1

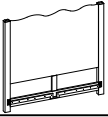

BX1

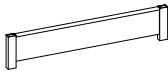

CX2

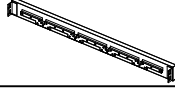

DX1

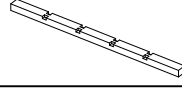

EX8

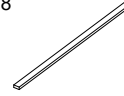

FX1



Step 1 -

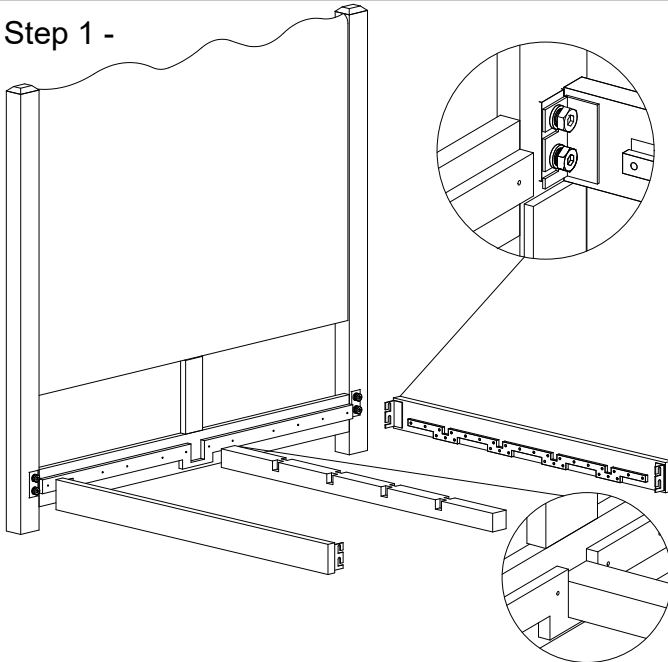

Step 2 -

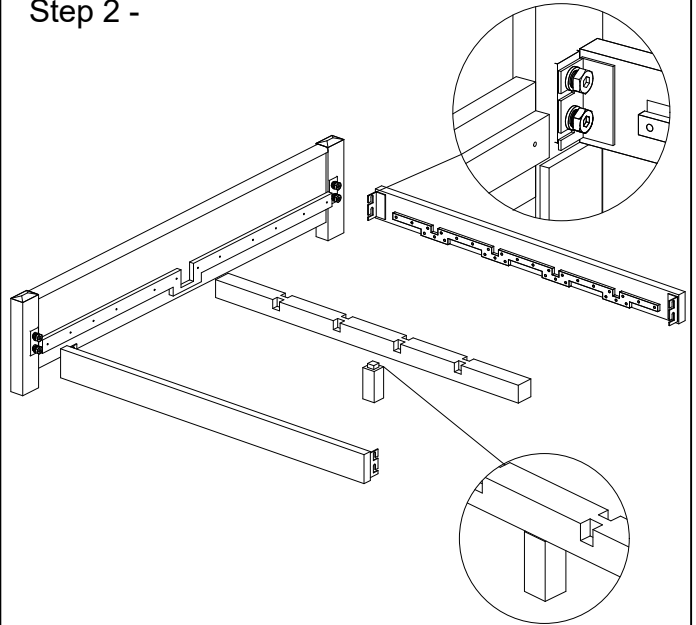

Step 3 - Assemble all supports.

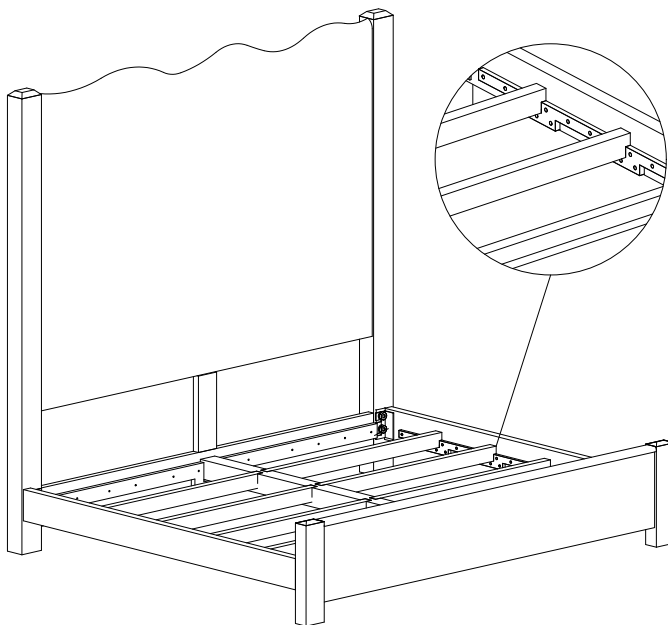

Step 4 - Your product is now ready for use.

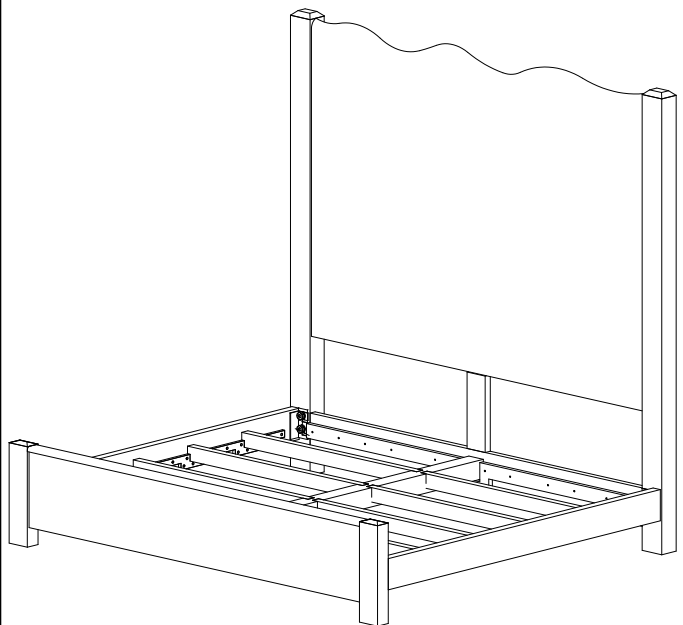

Care Instructions

Wipe with a soft, dry cloth. To protect finish, avoid the use of chemicals and household cleaners. Any liquid spilled onto the table should be cleaned up immediately with a damp cloth. Avoid keeping the product in direct sunlight.