

PURPLE LEAF

est. 2013

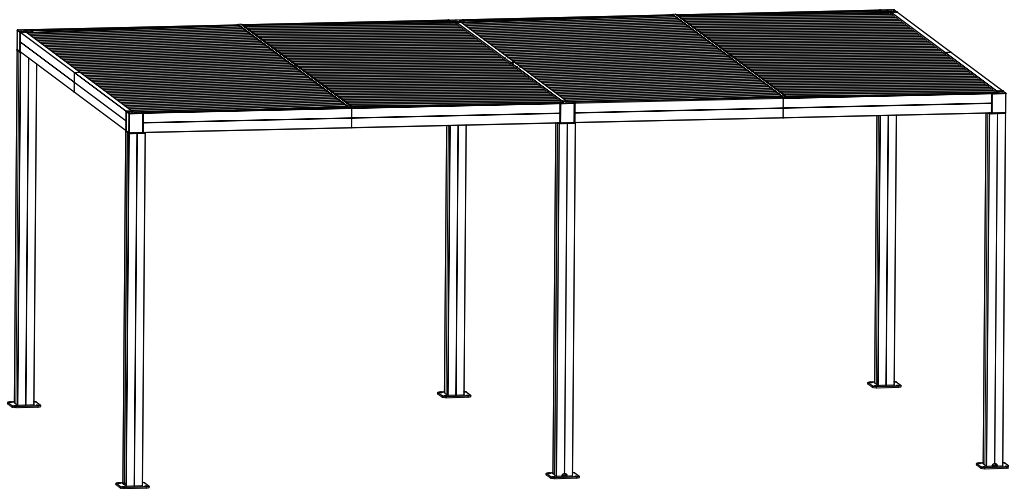

12' x 20' PERGOLA



Assembly Manual



There are heavy parts within the poles, it might be fell out while moving the poles.

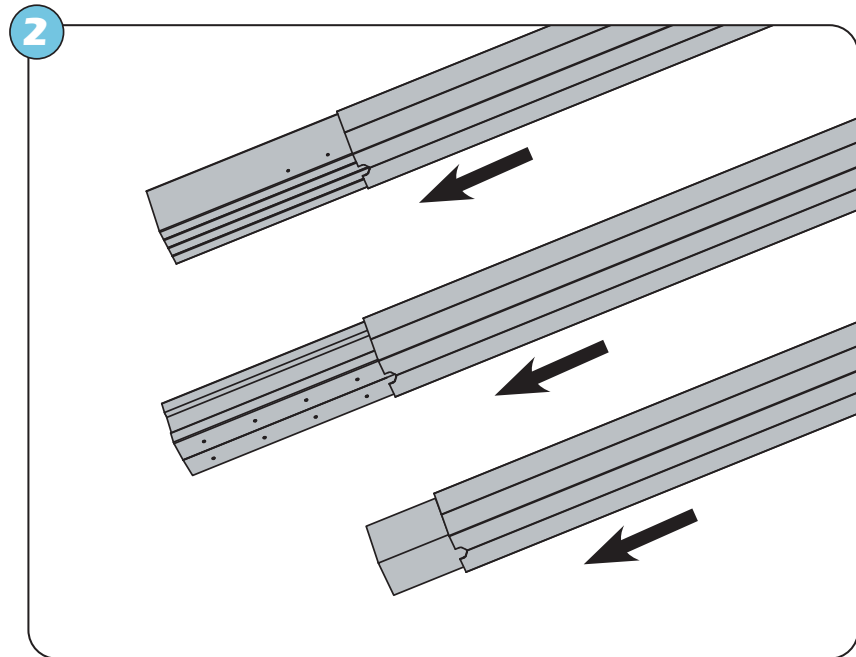
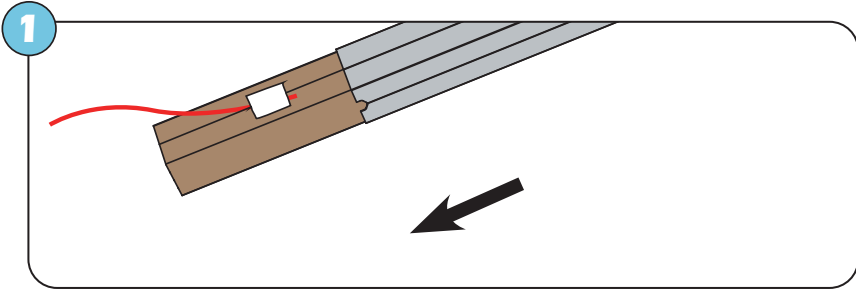

Gently remove hardware pack , K and L and I from one pole.

Different language instructions

If you want instructions in Spanish, French, German please contact Purple Leaf customer service.

Wenn Sie Anweisungen auf Spanisch, Französisch oder Deutsch wünschen, wenden Sie sich bitte an den Purple Leaf Kundendienst.

Si desea instrucciones en español, francés o alemán, comuníquese con el servicio de atención al cliente de Purple Leaf.

Si vous voulez des instructions en français, espagnol et allemand, veuillez contacter le service à la clientèle de Purple Leaf.

Warnings and Cautions

Please retain this instruction for future usage and read carefully before assembly.

Make sure you have all the parts and pack of fittings.

2 adults or more are recommended to install your pergola.

Do not discard any of the packaging until you have checked that you have all the parts and pack of fittings.

Check all bolts for tightness before use, and periodically check and tighten bolts to ensure your pergola works properly.

Some parts might have sharp edges/corners. Please follow basic safety precautions to reduce the risk of hurts.

It is essential to place the pergola on level ground.

Ladder is required for the installation.

Never fully tighten the screws until you finish the installation.





















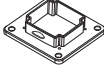



To reduce personal injury and damage to your pergola, please open the louver roofs when it is in heavy wind or heavy snow.

CHOKER HAZARD

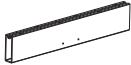

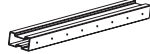











THIS ITEM CONTAINS SMALL PARTS WHICH CAN BE SWALLOWED BY CHILDREN.

PLEASE KEEP IT AWAY FROM CHILDREN UNDER 3 YEARS OLD AND PETS DURING INSTALLATION.

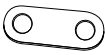
Parts List

Part No.	Image	Description	QTY	Part No.	Image	Description	QTY
A		Post	4	GG		Beam connector	1
A1		Post	2	E3		Middle Beam	1
B1		Side Beam with Louver Bracket	1	E4		Middle Beam	1
B2		Side Beam with Louver Bracket	1	F		Louver Blade	204
C1		Side Beam	2	G		Post Base	6
C2		Side Beam	2	H		Beam Corner Cap	4
C3		Side Beam	2	I		Beam Corner Cover	4
C4		Side Beam	2	J		Louver Crank Handle	1
D1		Side Beam with Louver Bracket	1	K		Beam connector	6
D2		Side Beam with Louver Bracket	1	L		Center sill connector	2
E1		Middle Beam	2	M		Hex Bolt (M6x15)	24
E2		Middle Beam	2	O1		Bolt (M6x20mm)	8

Toolkit List

Part No.	Image	Description	QTY	Part No.	Image	Description	QTY
N		Hex Bolt/ Nuts+WASHER (M6x50mm)	24	Y		Allen Key (M6mm)	2
N1		Hex Bolt/ Nuts+WASHER (M6x40mm)	4	Y1		Allen Key (M5mm)	2
N2		Hex Bolt/Nuts (M6x40mm)	4	Z		Spanners (13mm)	2
O		Hex Bolt/ Nuts+WASHER (M6x15mm)	16	AA BB		Spare Louver Bracket	AA-2 BB-2
P		Bolt (M5x10mm)	140	aa bb		Spare Louver Bracket	aa-1 bb-1
S		Bolt (M5x20mm)	10	CC		Transmission rod connecting piece	9
T		Expansion Bolt (M10x80mm)	24	DD		Gutter	6
U		Bolt (M6x12mm)	17	EE		Gutter	4
V		Louver Control Loop	4	FF		Gutter	2
W		Center sill fixing block	4	HH		Beam Corner Cover	2
X		Screwdriver	2	LI		Beam Corner Cap	2

Before Assembly

Please be aware that assembly of the pergola is a complicated and involved process requiring a certain amount of technical ability and time. If you are in any doubt about assembly it is recommended you enlist the help of a qualified tradesperson.

It is recommended that assembly should be conducted by a minimum of 2-3 people. Certain stages of the assembly will require the use of multiple step ladders and, if securing into concrete or other solid ground you will require a masonry drill.

It is important that you carefully measure and mark out the location of the pergola posts.

The pergola must be located on flat, level ground and the posts positioned equally apart.

Failure to do the above may result in sub-optimum operation of the mesh sidewalls.

MOUNTING BLUEPRINT

Pergola 12'x20'

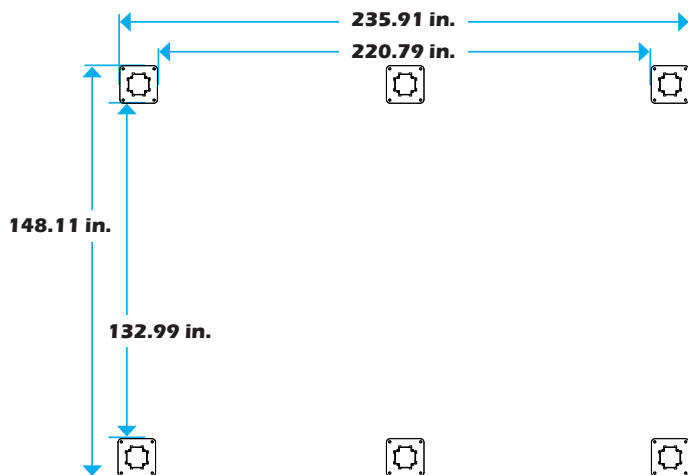

Attention: The above dimensions are manually measured and error is within 1-2 inches. We suggest you anchor the pergola after installed the whole product.

Top View

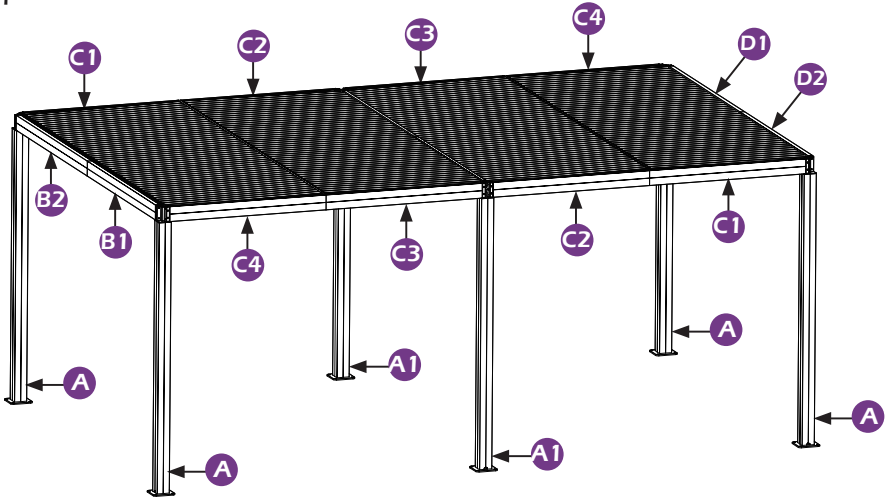

Posts are labelled with lettered stickers "A" and "A1".

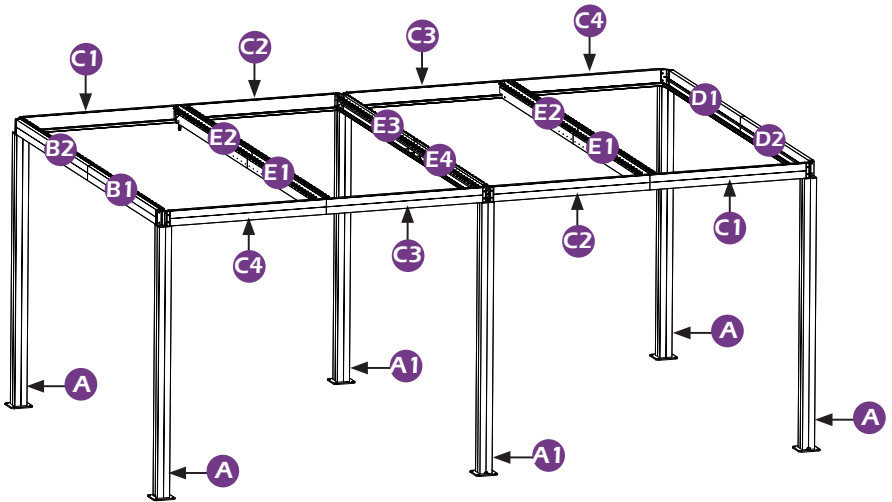

Beams are labelled with lettered stickers "B1", "B2", "C1", "C2", "C3", "C4", "D1", "D2", "E1", "E2", "E3" and "E4".

Framework Assembly

A X4

A1 X2

G X6



M X24



Y X1

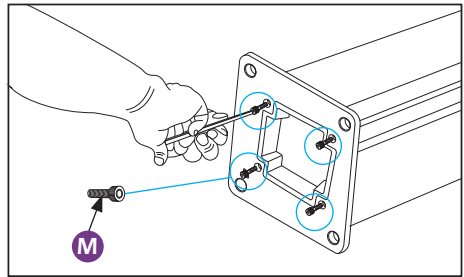
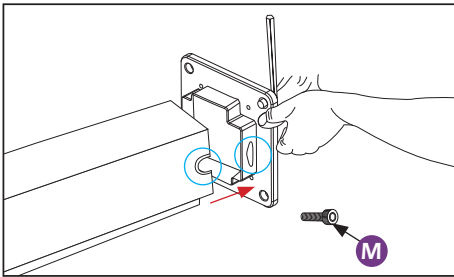
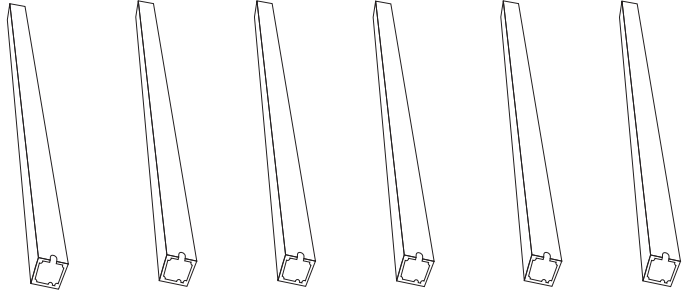

Match Post Base **G** to Post **A** and **A1** by Bolt **M**. Then, the bottom plate outlet hole must be on the same side as the column outlet hole.

Insert and tighten 4x **M** Bolts by Allen Key **Y**.

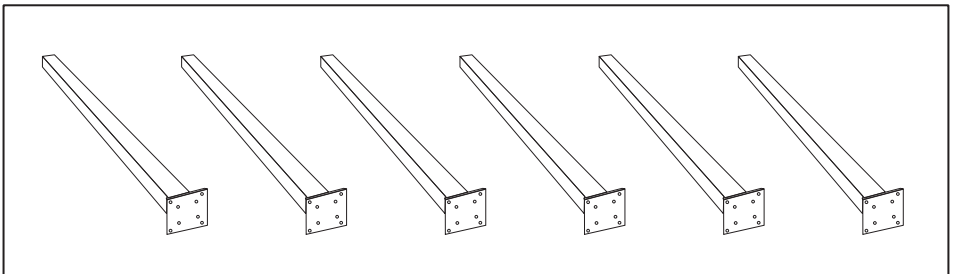

Repeat for all Posts.

STEP 1

Cross beam steps

C1 X2 

C2 X2 

C3 X2 

C4 X2 

P X48 

X X1 

K X4 

DD X4 

01

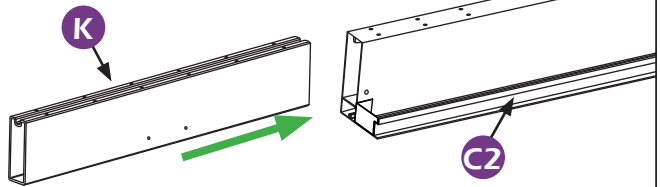

02

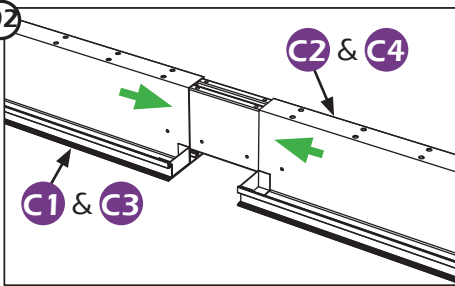

03

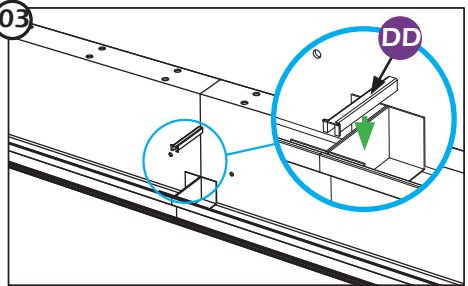

04

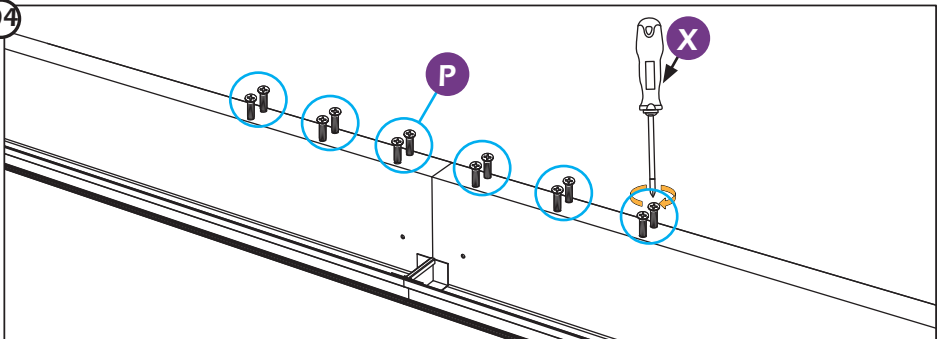

Put part **K** into the cross beam and part **DD** to the joint of the beam like the above pictures. Then lock the beam with **P** bolts so that the **C1** & **C2, C3** & **C4** beams are integrated.

STEP 2

Edge beam steps

B1 X1 

D1 X1 

CC X2 

B2 X1 

D2 X1 

DD X2 

U X4 

P X24 

Z X2 

K X2 

X X1 

01

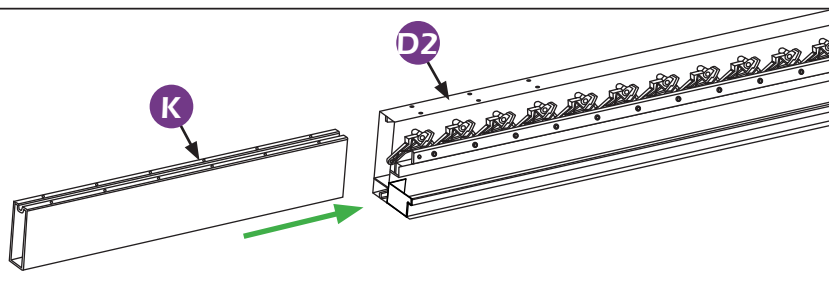

02

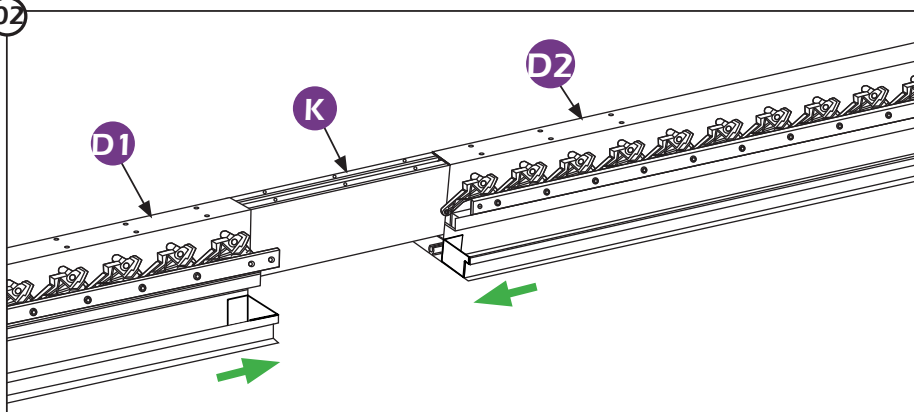

STEP 3

03

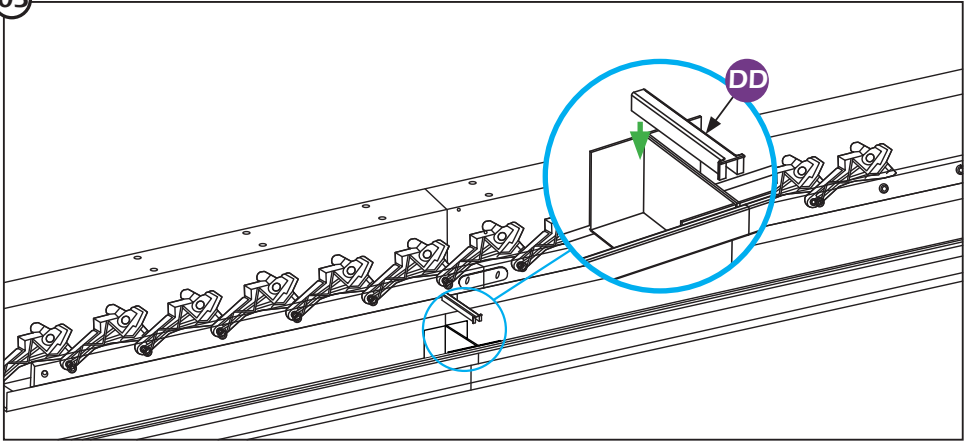

04

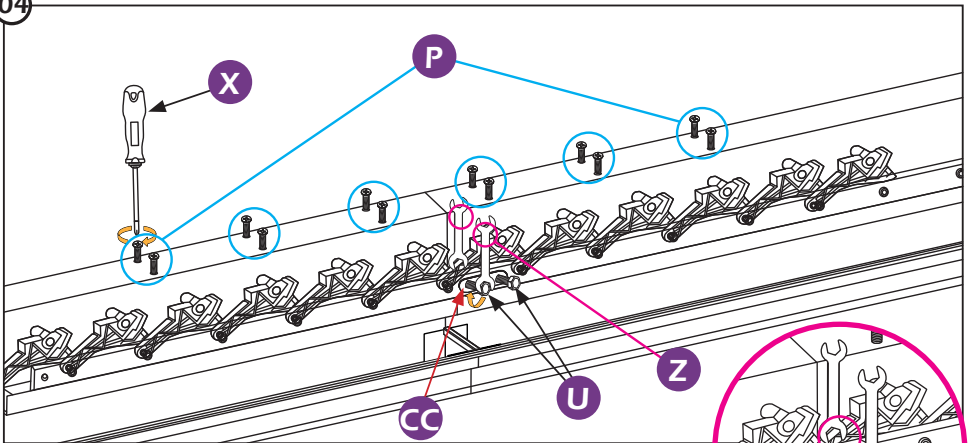

Ensure that the other side has a nut.

Put part **K** into the cross beam, part **DD** to the joint of the beam like the above pictures and lock the beam with **P** bolts.

Then fix both sides of the transmission rod with part **CC** and **U** bolst to make the corss beam become a whole. Repeat this step for parts **B1** & **B2**.

STEP 3

Edge beam steps

E3 X1



GG X1



CC X2

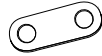

E4 X1



P X8



FF X2



U X2



X X1



Z X1

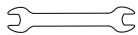

01

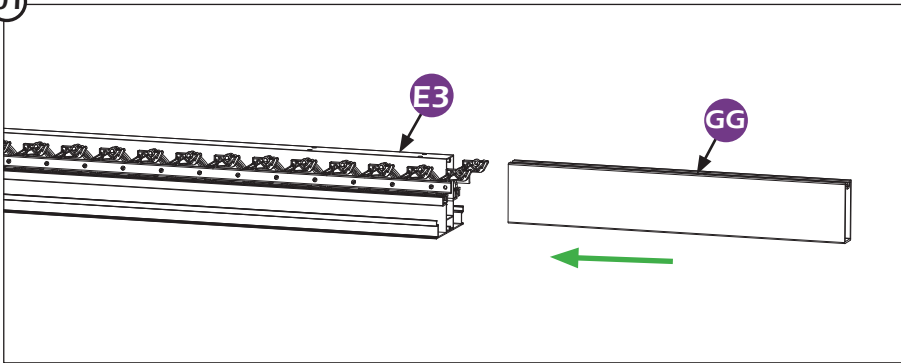

02

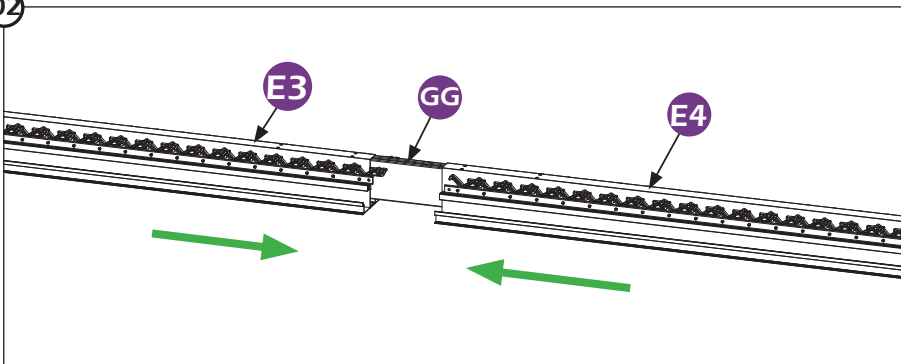

STEP 4

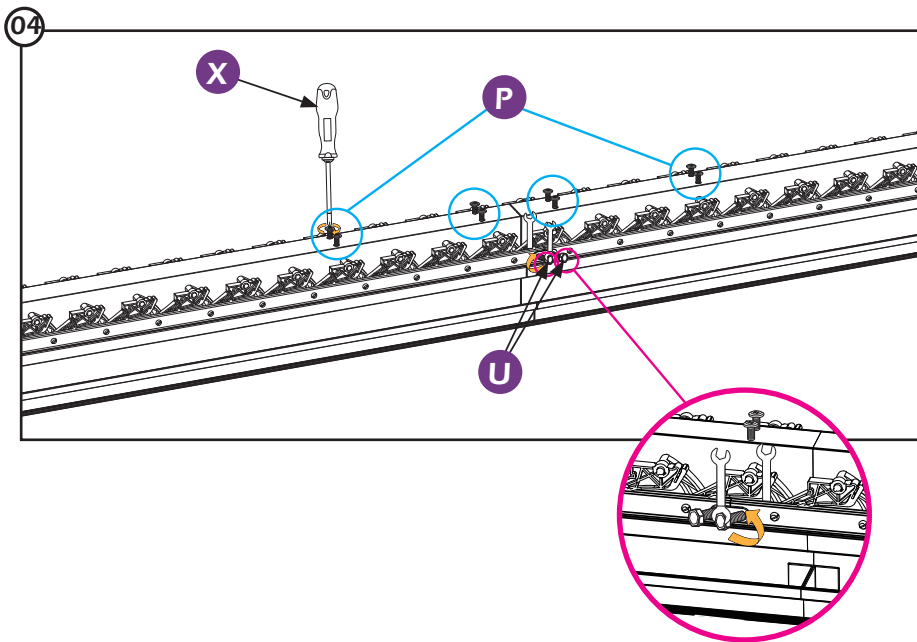
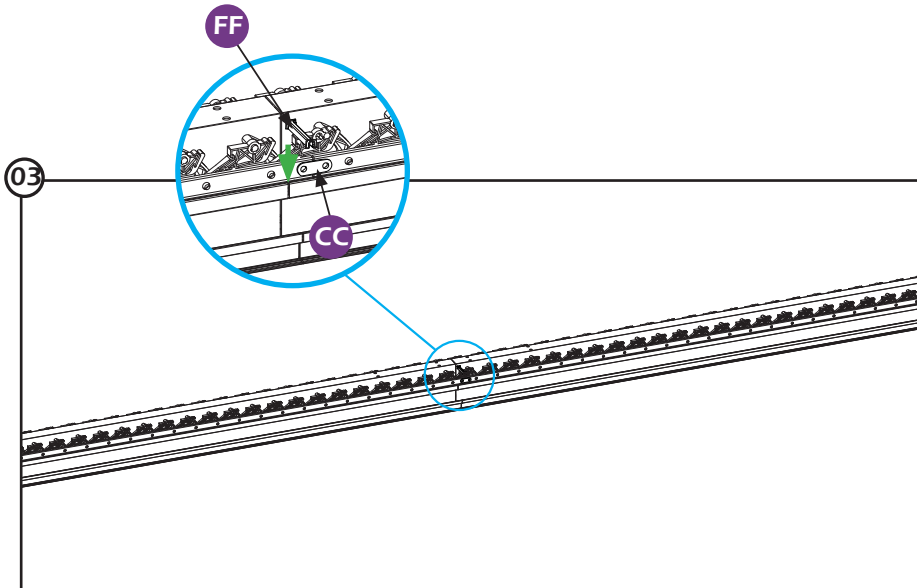

STEP 4

N X24 

O X16 

O1 X8 

Z X2 

N1 X4 

N2 X4 

Y X2 

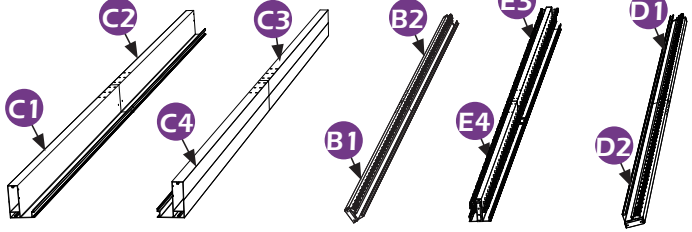

Beam B1 & B2



Beam E4 & E3



When Installed correctly,
all lower brackets will face
the same direction.

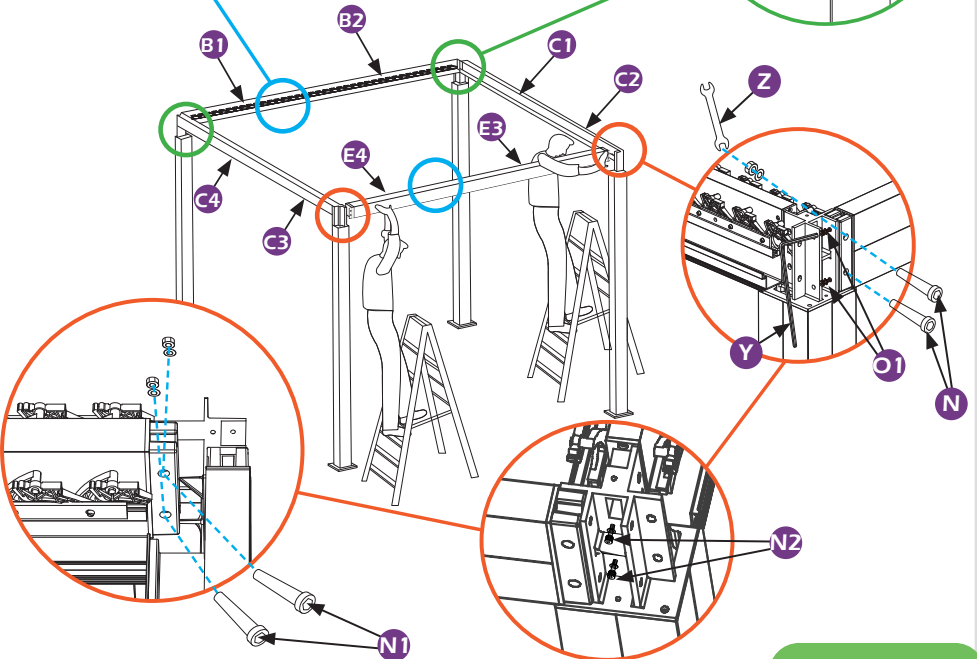
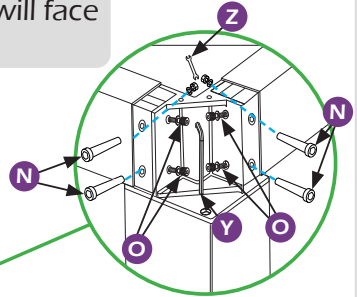

Assemble the frame as per the above graphic.

STEP 5

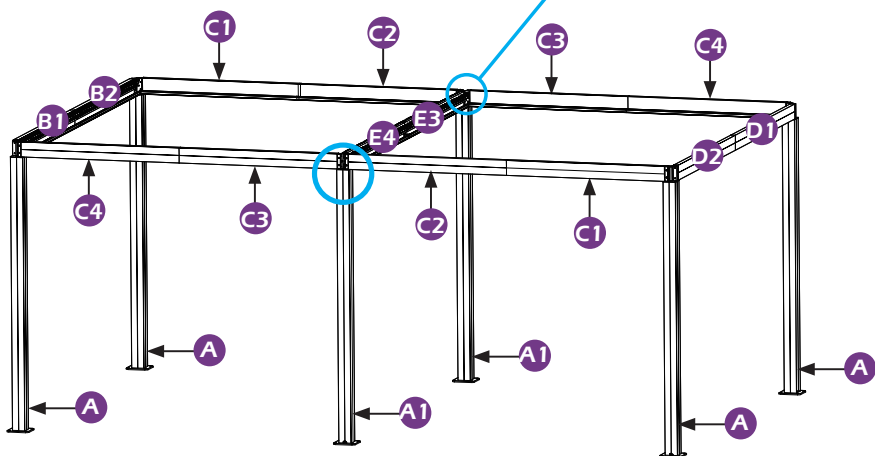
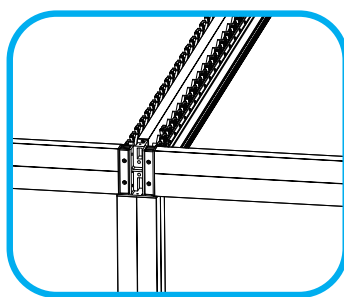
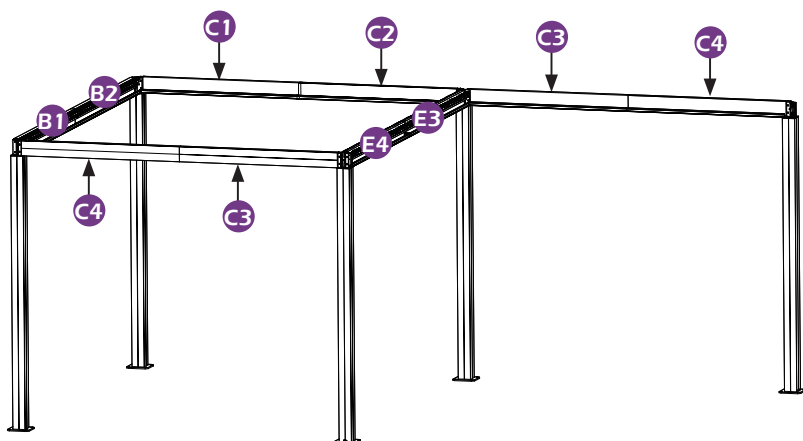

STEP 5

Recommended Installation Method.

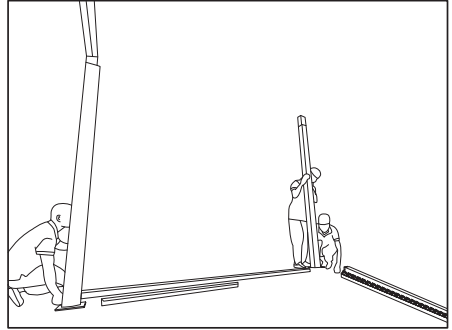
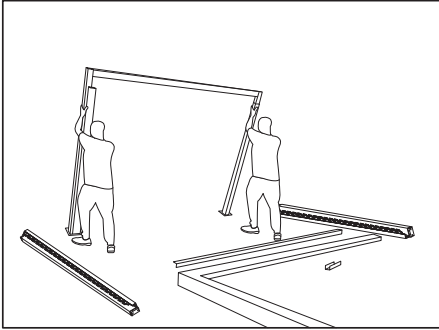

Move Posts **A** and Beam **C1** & **C2**, **C3** & **C4** into position and erect.

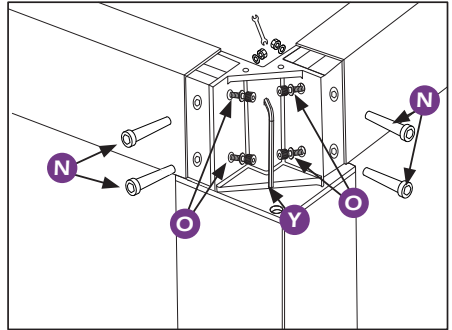
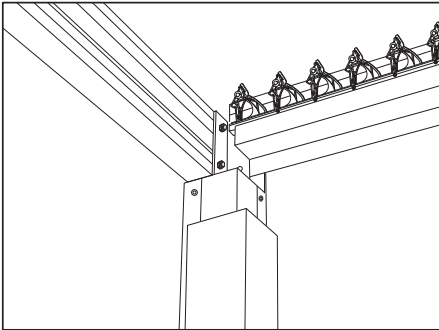

Attach Beam **B1** & **B2**, **D1** & **D2** to Post **A** using 16x **N** Bolts and Nuts, 16x **O** Bolts.

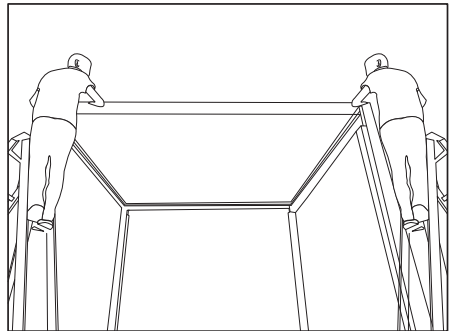
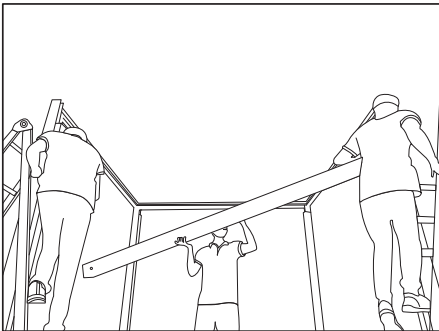

Now repeat to attach Beam **E3** & **E4** to Posts **A1** using 8x **O1**, 4x **N1**, 4x **N2** Bolts .

STEP 5

Center Beam Procedure

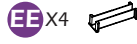
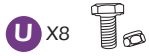

01

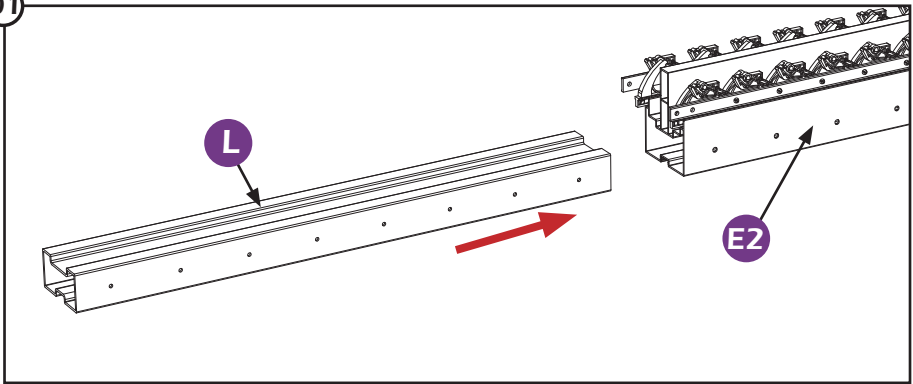

02

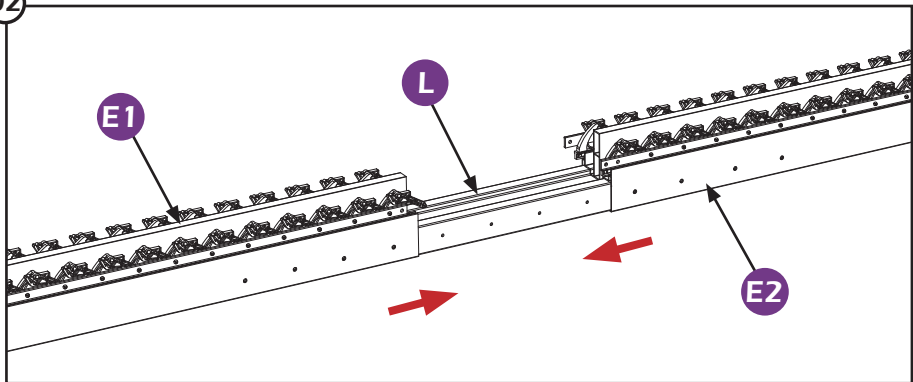

STEP 6

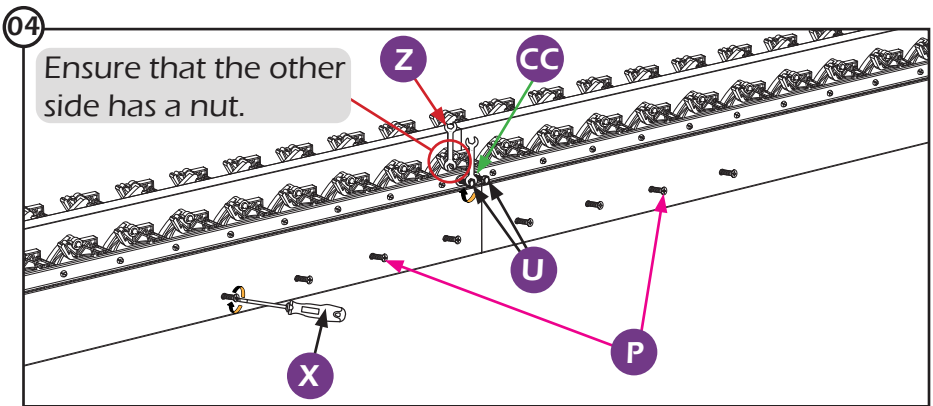
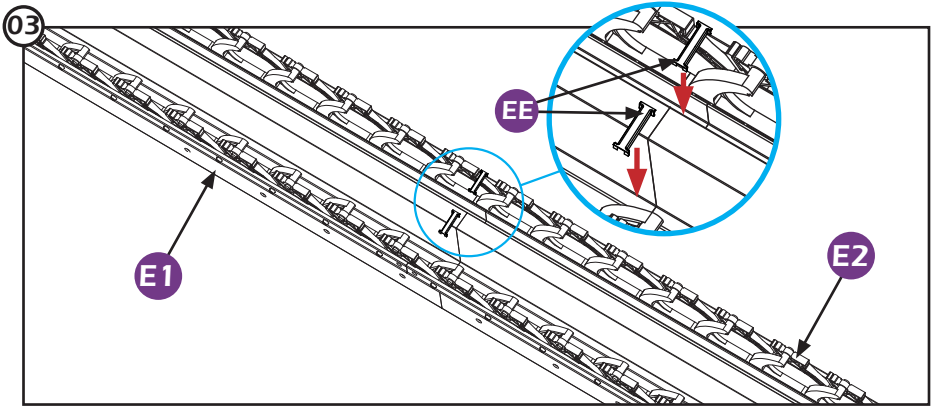

Put part **L** into the center beam, part **EE** to the joint of the beam like the above pictures and lock the beam with **P** bolts.

Then fix both sides of the transmission rod with part **CC** and **U** bolts to make the center beam become a whole.

STEP 6

Center Beam Procedure

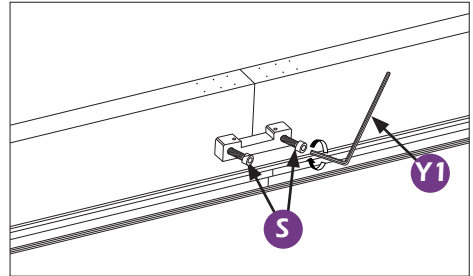
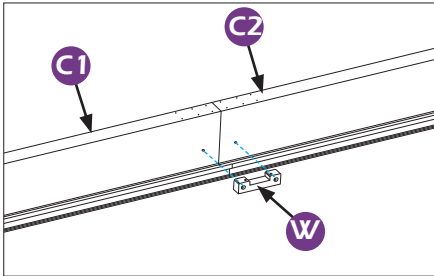
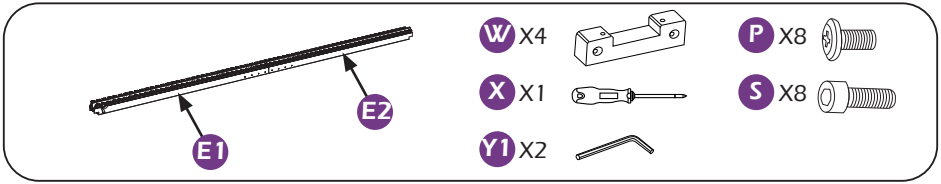

Attach Middle Beam Support **W** x4 to Beam **C1** & **C2**, **C3** & **C4** by Bolts **S**.

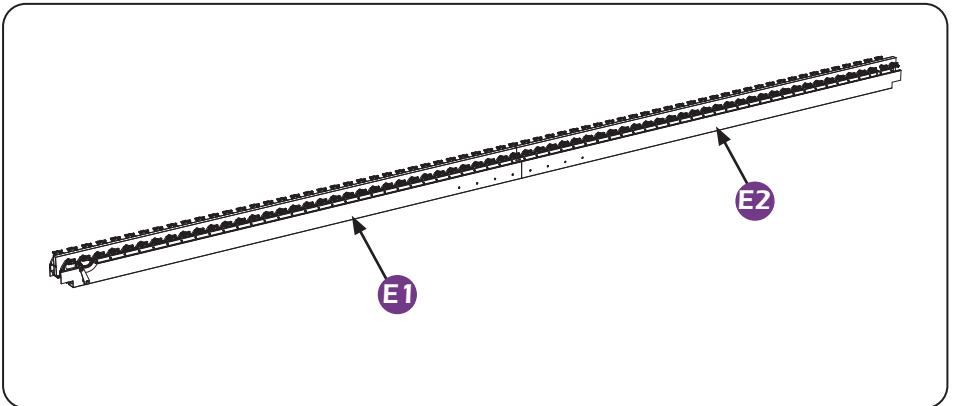

STEP 7

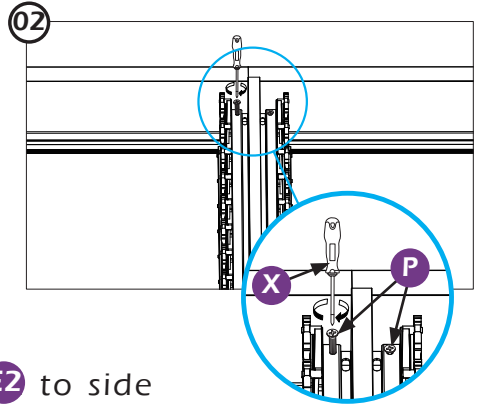
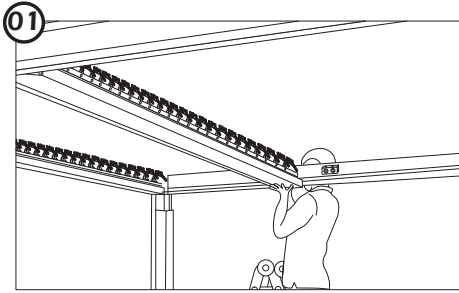

Attach middle beam **E1** & **E2** to side beam **C1** & **C2** , **C3** & **C4** with **P** screws.

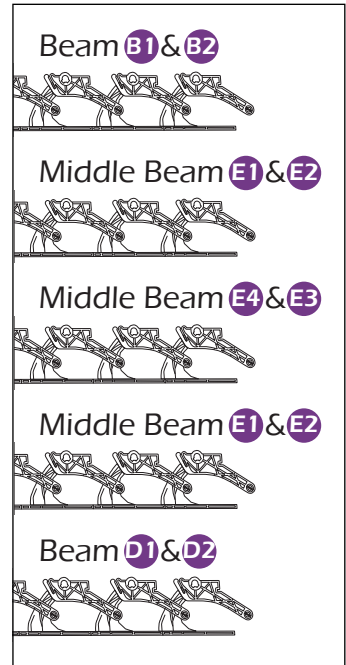
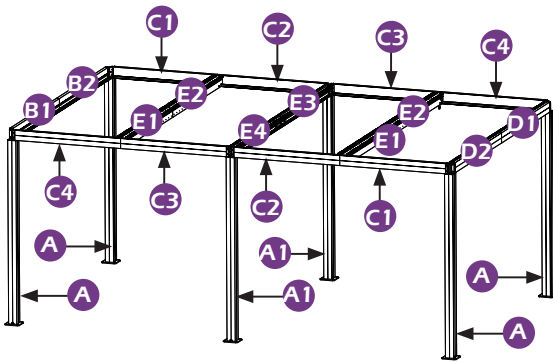

When Installed correctly,
all lower brackets will face
the same direction.



STEP 7

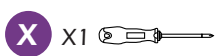
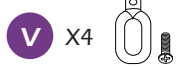

03

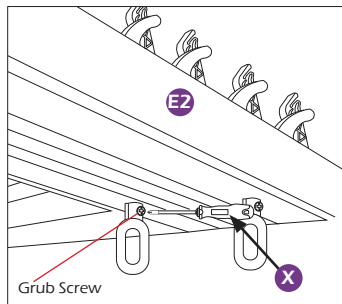
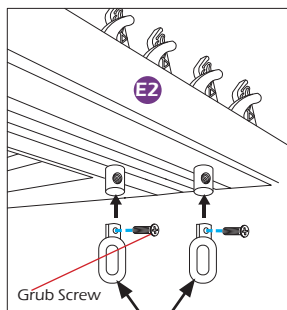
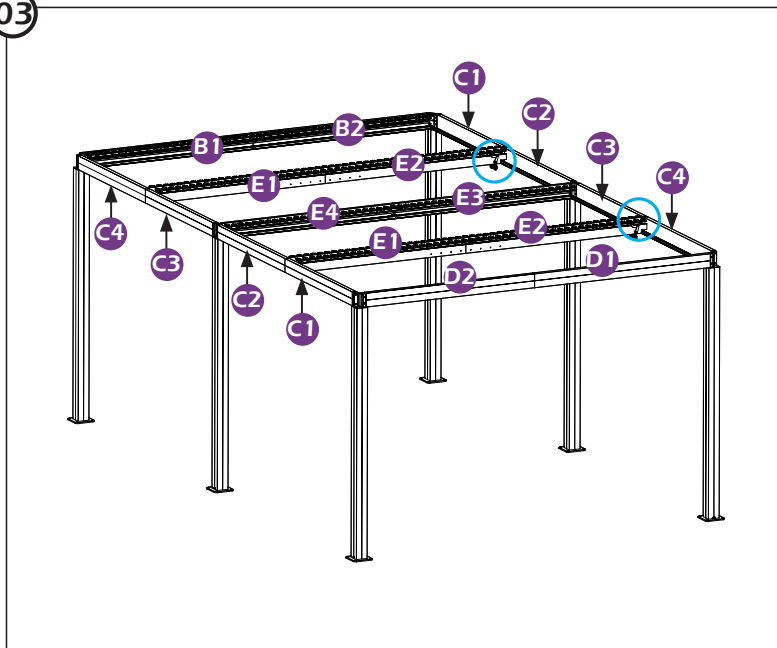

Please put part **V** on the middle beam and assembly it with grub screw.

STEP 7

Louver Assembly

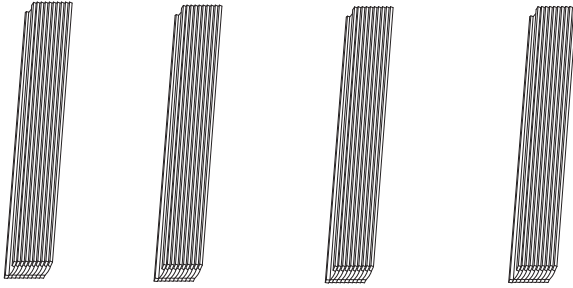

F X204

J X1

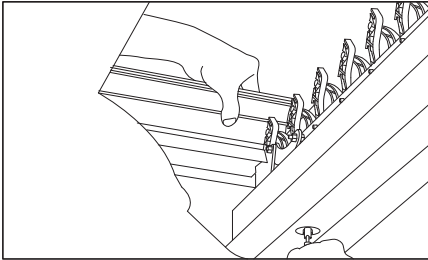

Clamp both ends of the Louver Blade into the Brackets located on the beams.

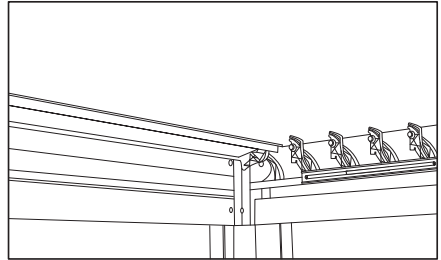

Please note: The front (IPC) and Bottom (IPC) Blades are attached differently to the others, as per above image.

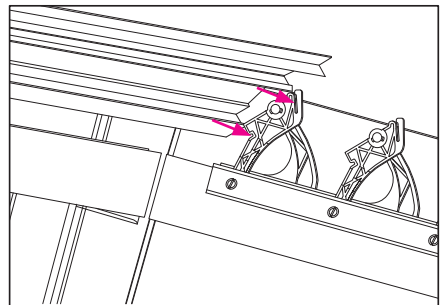
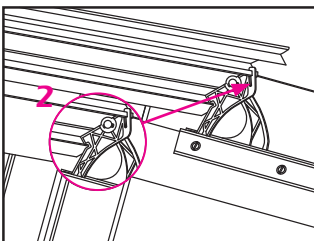
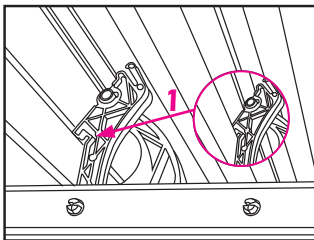

STEP 8

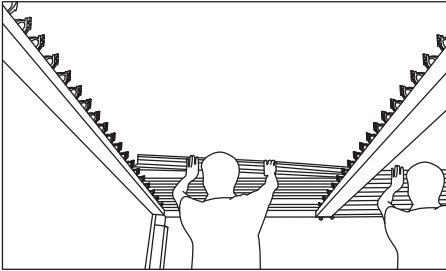

Two People Install the remainder of the Louver Blades together, ensuring correct alignment.

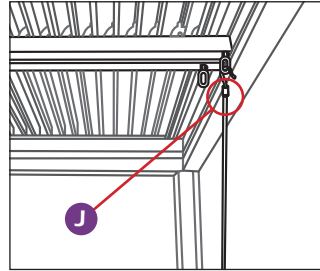

Control the Louver Blades using Crank Handle **J** supplied.

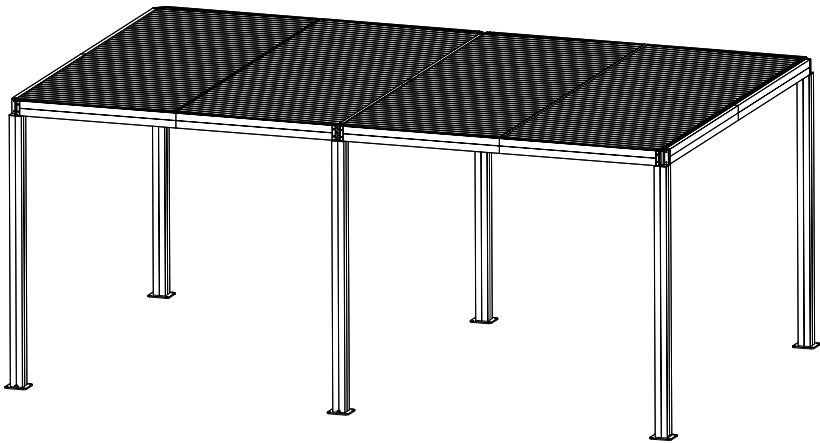

STEP 8

H X4

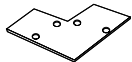

HH X2



I X4



P X20



LI X2



X X1

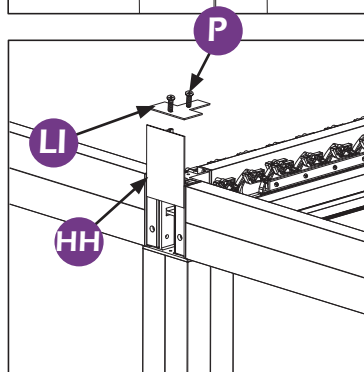
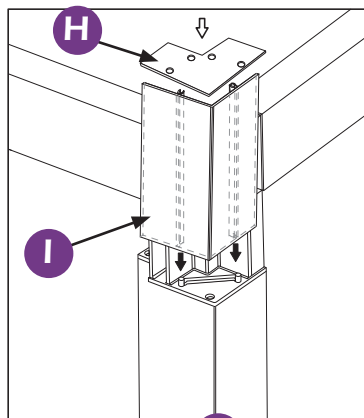
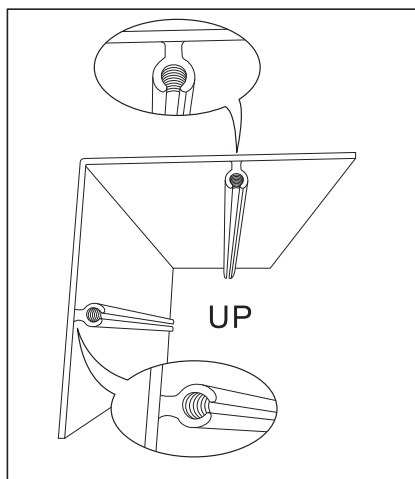

Once all of the parts are in place like the picture above, install part **H** to **I** and part **LI** to part **HH** by bolts **P**.

Make sure the end of Beam Cover with screw thread are up so that bolt **P** can be tightened with it.

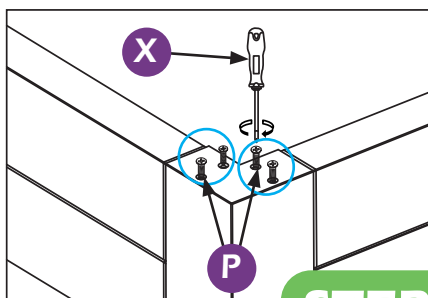

STEP 8

Securing your Pergola

01

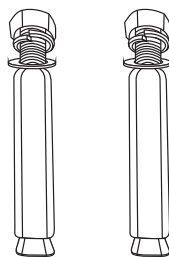
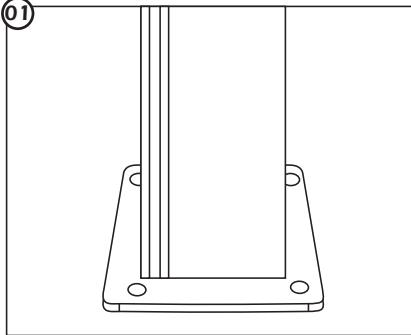

T X24

Securing into Concrete

When securing your pergola into solid ground such as concrete or paved area, please use the expansion bolts **T**.

02

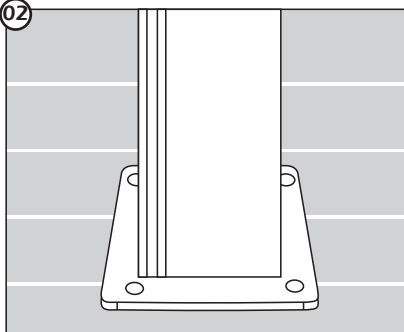

Attention: **Wood screws are not in packing list.** You have to purchase it based on the specification of your decking wood.

Securing into Wood

When securing your pergola into a wooden surface such as decking, please use suitable wood screws with a diameter of 10mm and a length which suitable for your decking wood thickness.

STEP 9

Usage instructions: Louvered roof

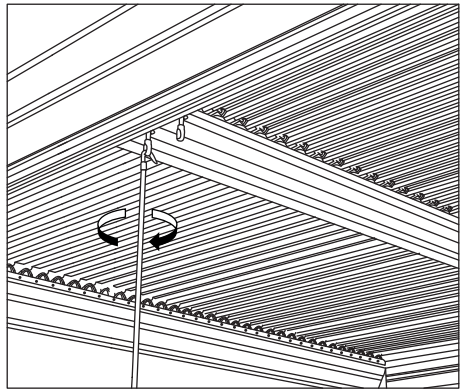
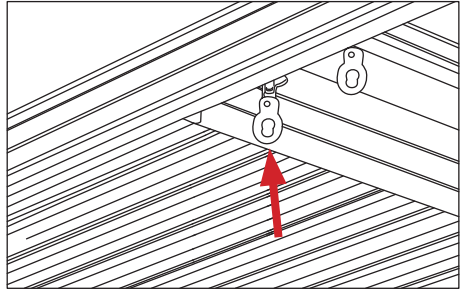
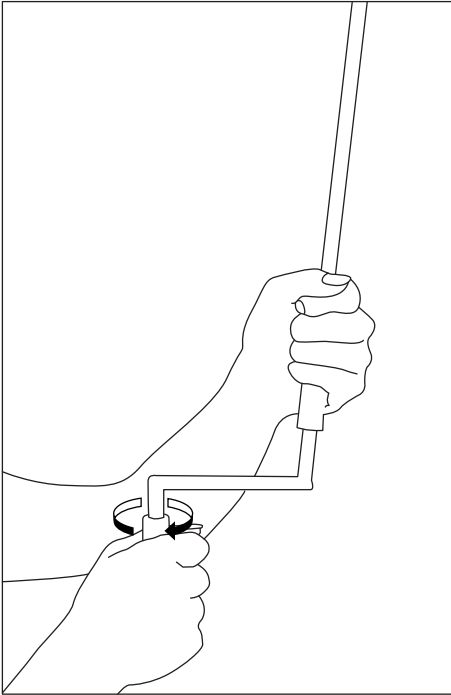

Locate the Louver control loops, insert Crank Handle and turn clockwise to open and anti clockwise to close.

STEP 9

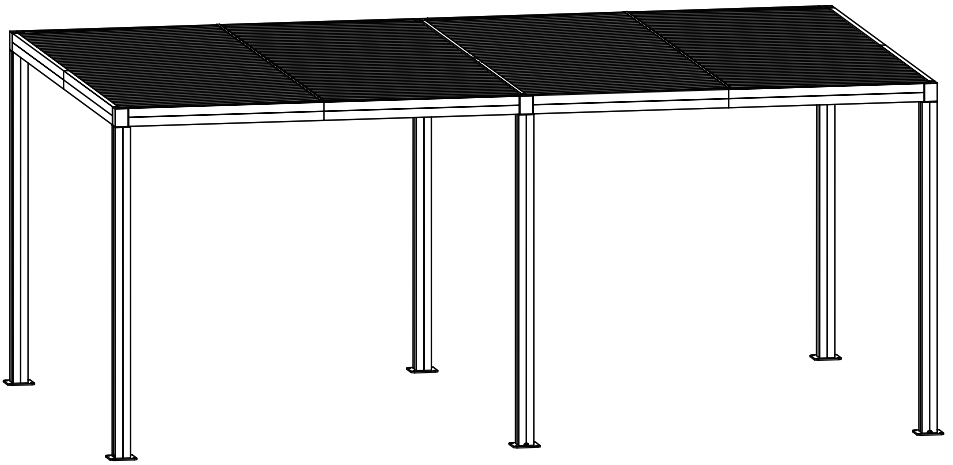

Care and Maintenance

Wash frame parts with mild soap and water, rinse thoroughly. Dry frame completely.

Do not use bleach, acid, or other solvents on the frame parts.

Please inspect and tighten all bolts or fasteners on a regular basis to ensure proper performance and safety of your pergola.

Warranty

Frames

Frames constructions are warranted to be free from defects in material and workmanship for 1 year from item purchased. Damage to frame from negligence won't be covered by this warranty.

Bolts & Nuts

Bolts and nuts are warranted to be free from defects in material and workmanship for 1 year from item purchased. Damage from exposure to chemicals (including not only oils, spills, fluids) won't be covered by this warranty.

Warranty Limitation

This warranty is for the original purchase order only. (Order number required). This warranty is non-transferable. Purple Leaf is responsible for the free replacement part including shipping charges for the 1 year warranty.

Warranty Exclusion

This warranty does not cover products subject to negligence, abuse usage, inappropriate installation. Purple Leaf reserves the right to explain warranty exclusions. When the replacement item is applied, the 1 year warranty automatically expires. Please feel free to contact us to apply for a warranty.



*Purple Leaf Inc.
15950 Boyle Avenue, Fontana
CA, 92337
pergola2@purpleleafgarden.com
©Copyright 2013-2025 Purple Leaf Inc.
All Rights Reserved.V.2*