



626-679-3588  
service@getprohome.com  
www.getprohome.com  
162 Atlantic St, Pomona, CA 91768

# INSTALLATION MANUAL

## ACRYLIC SHOWER BASE



PRODUCT  
INSTRUCTION  
VIDEO



READ ENTIRE INSTALLATION  
GUIDE PRIOR TO INSTALLING  
THE SHOWER BASE



# THANK YOU!

*Dear Valued Customer,*

*Thanks to your kind support of GETPRO, we hope our product can improve the quality of your life.*

*As our valued customer, your comments and opinions are very important to us. If you have any concerns, questions, or comments, we hope that you will bring them to our attention.*

*Please keep the carton and packaging materials until your product is completely installed.*

*Feel free to contact us if you encounter any problems such as missing parts, or product defects during the installation process. We are happy to provide you with the most sincere service.*

*Sincerely,  
Service Team*

# AVAILABLE SIZES

## W 36" x D 36"

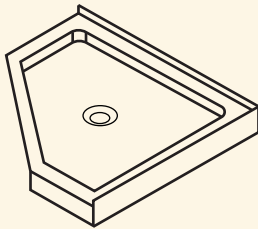

GS-SB3636NA

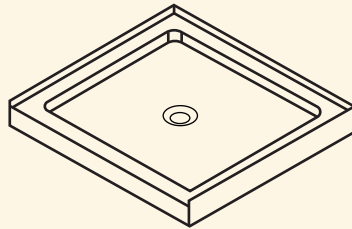

GS-SB3636M

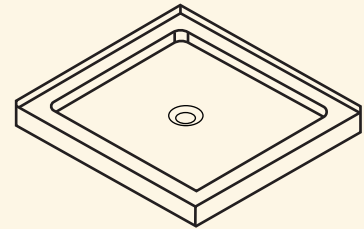

GS-SB3636DT

## W 48" x D 32"

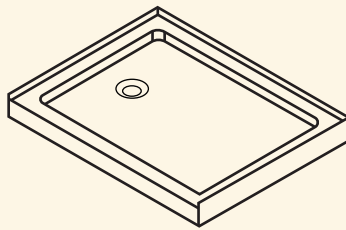

GS-SB4832L

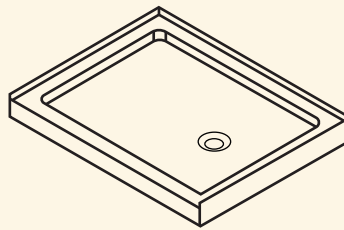

GS-SB4832R

## W 60" x D 30"

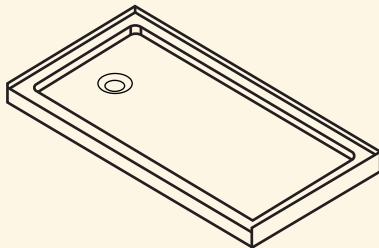

GS-SB6030L

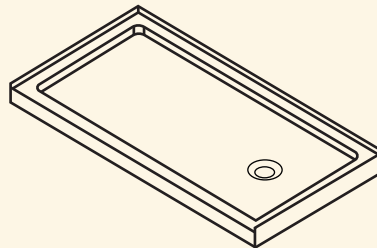

GS-SB6030R

## W 60" x D 32"

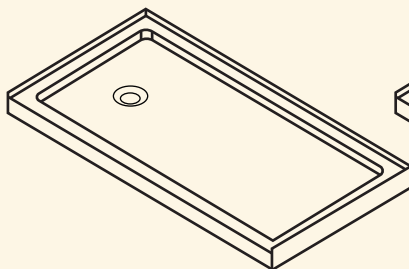

GS-SB6032L

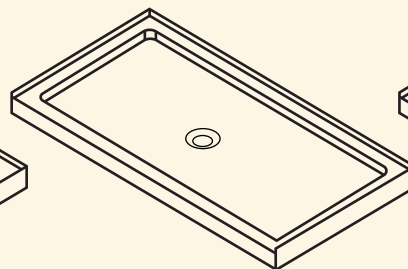

GS-SB6032M

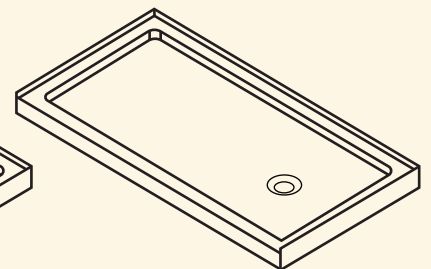

GS-SB6032R



Please read all instructions carefully before proceeding with installation.



Due to the complexity of the installation procedure, a professional plumber is required.

---

## **TABLE OF CONTENTS**

<b>1. Pre-installation Checklist</b>	<b>P4</b>
<b>2. Tools Required</b>	<b>P5</b>
<b>3. Installation Instructions</b>	<b>P6</b>
<b>4. Care &amp; Maintace</b>	<b>P17</b>
<b>5. Warranty</b>	<b>P19</b>

# PRE-INSTALLATION CHECKLIST

## Choose the Shower Base:

\*Select a shower base that fits your space and matches your design preferences.

## Check Local Building Codes:

\*Review local regulations regarding plumbing and bathroom renovations to ensure compliance.

## Measure the Space:

\*Measure the area designated for the shower base (length, width, and height).

\*Measure the existing drain to ensure compatibility with the new base.

## Inspect the Shower Base:

Opened all the boxes, read the instruction and inspect the shower base thoroughly, ensure all the necessary components are included and no damaged. Do not install the base and contact our service team for support immediately.

## Inspect Existing Plumbing:

\*Check that the existing drain aligns with the drain hole in the shower base.

\*Ensure the plumbing is in good condition and free of leaks.

## Adjust Plumbing if Necessary:

Consider hiring a licensed plumber if adjustments are needed to the drain or supply lines.

## Inspect the Subfloor:

\* Check for damage or not and repair as needed.

\* Ensure the subfloor is clean, dry, and free of debris.

## Level the Subfloor:

Use a level to ensure the subfloor is even. Address any low spots or bumps.

## Dry Fit the Shower Base:

Place the shower base in the intended location to verify positioning and drain alignment.

## Additional Considerations

### Waterproofing:

\* Consider waterproofing measures, like adding a moisture barrier or waterproof membrane if necessary.

### Plan for Wall Installation:

\* If installing wall panels or tiles, ensure materials are ready and plan how they will be affixed to the walls.

### Wear Safety Gear:

\* Use safety goggles and gloves during installation to protect against injury.

### Clear the Area:

\* Remove any obstacles in the bathroom to create a safe workspace.

### Time Management:

\* Set aside sufficient time to complete the installation without rushing.

### Cleanup Supplies:

\* Have towels or cloths handy for clean-up during installation.

# TOOLS REQUIRED



Level



Jigsaw



Tape Measure



Pencil



Power Drill

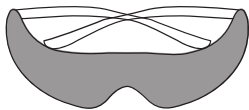

Safety Goggles



3/16" (5mm)  
Drill Bit



Screws #8 x 32 mm  
(1 1/4" Stainless Steel)



Construction  
Adhesive



Mortar  
Compound

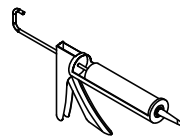

Silicone Caulk

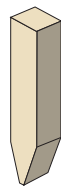

Furring Strips

# INSTALLATION INSTRUCTIONS

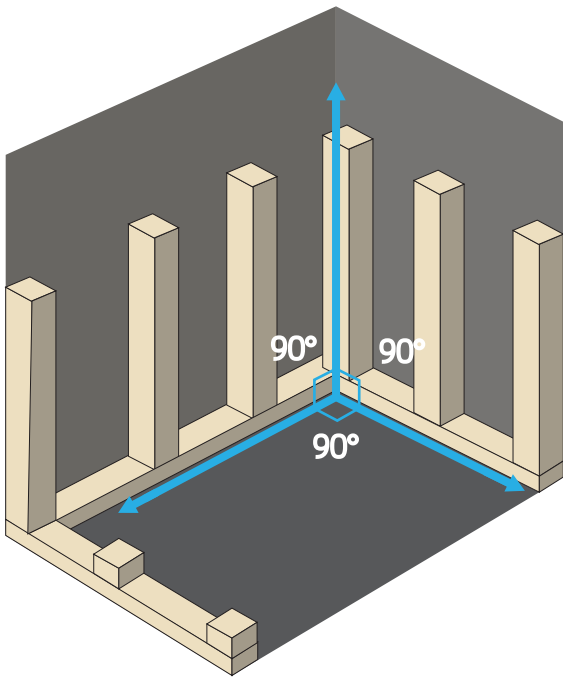

## Step1

Set up the studs frame for the shower base area, it's probably measured with the angle finder, and make sure the corner and platform are 90° .

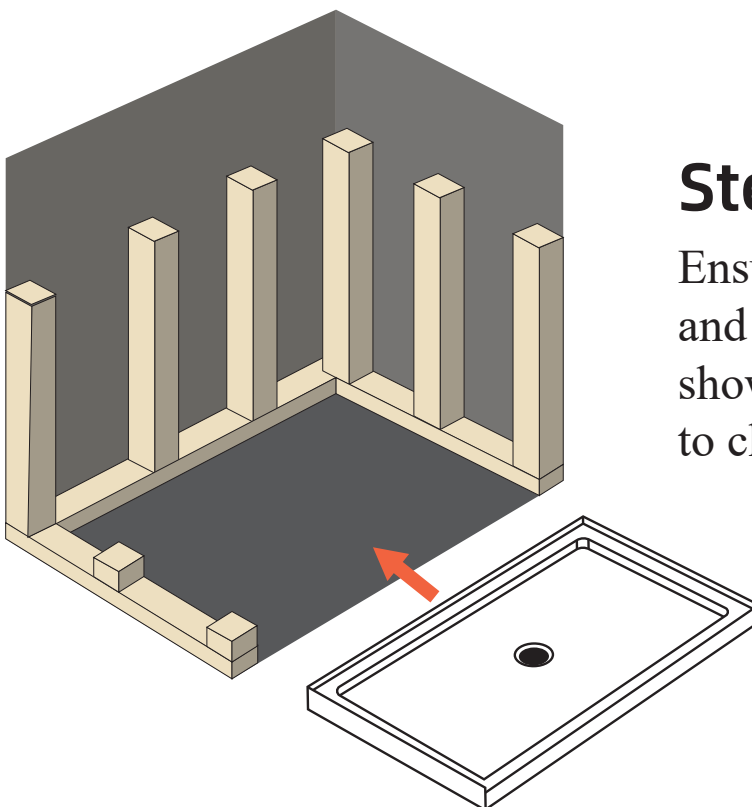

## Step2

Ensure the subfloor is clean, dry and structurally sound. Place the shower base in the desired position to check for fit.

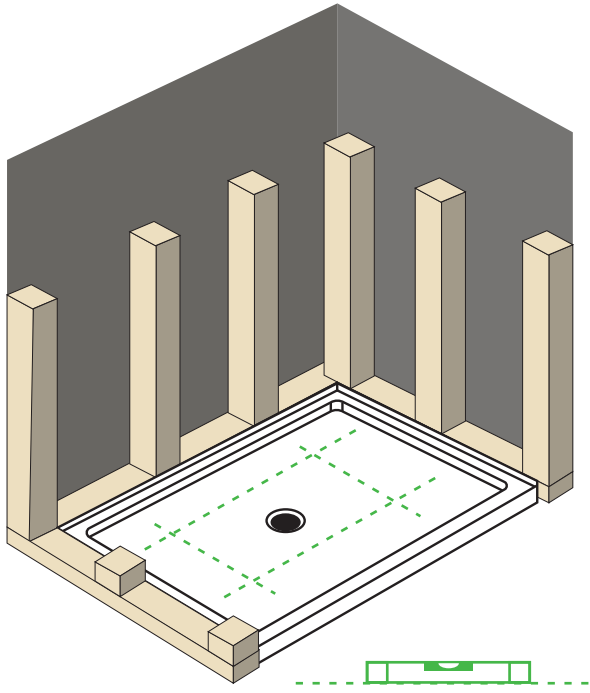

## Step3

Use the level to check that the 4 sides of the shower base are leveled. Make sure all sides are leveled. You might need to adjust the subfloor if it wobbles or is not flat.

## Step4

Make the drain location and the studs stability point.

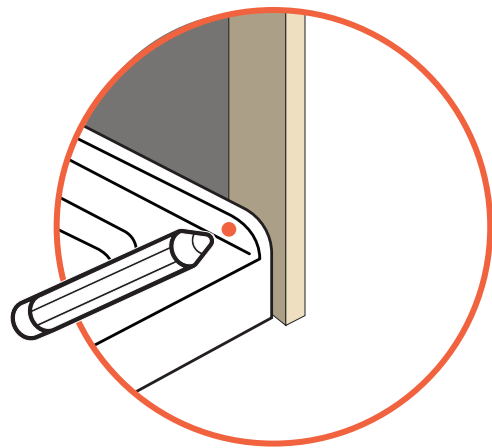
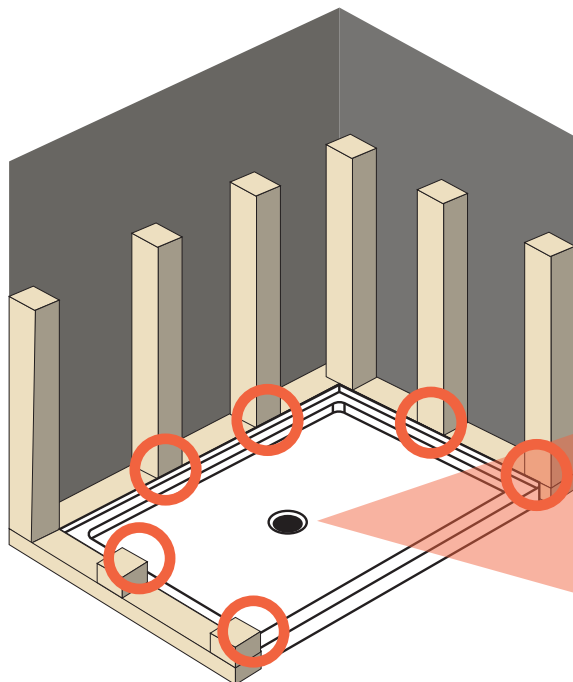

## Step5

According to the mark points, use a 3/16"(5mm) drill bit for pre-drilling holes in the shower base flanges. Make sure to drill holes in the flange only from the inside. Ensure the bottom of all holes in the flange is positioned at least 3/8"(8mm) above the base threshold.

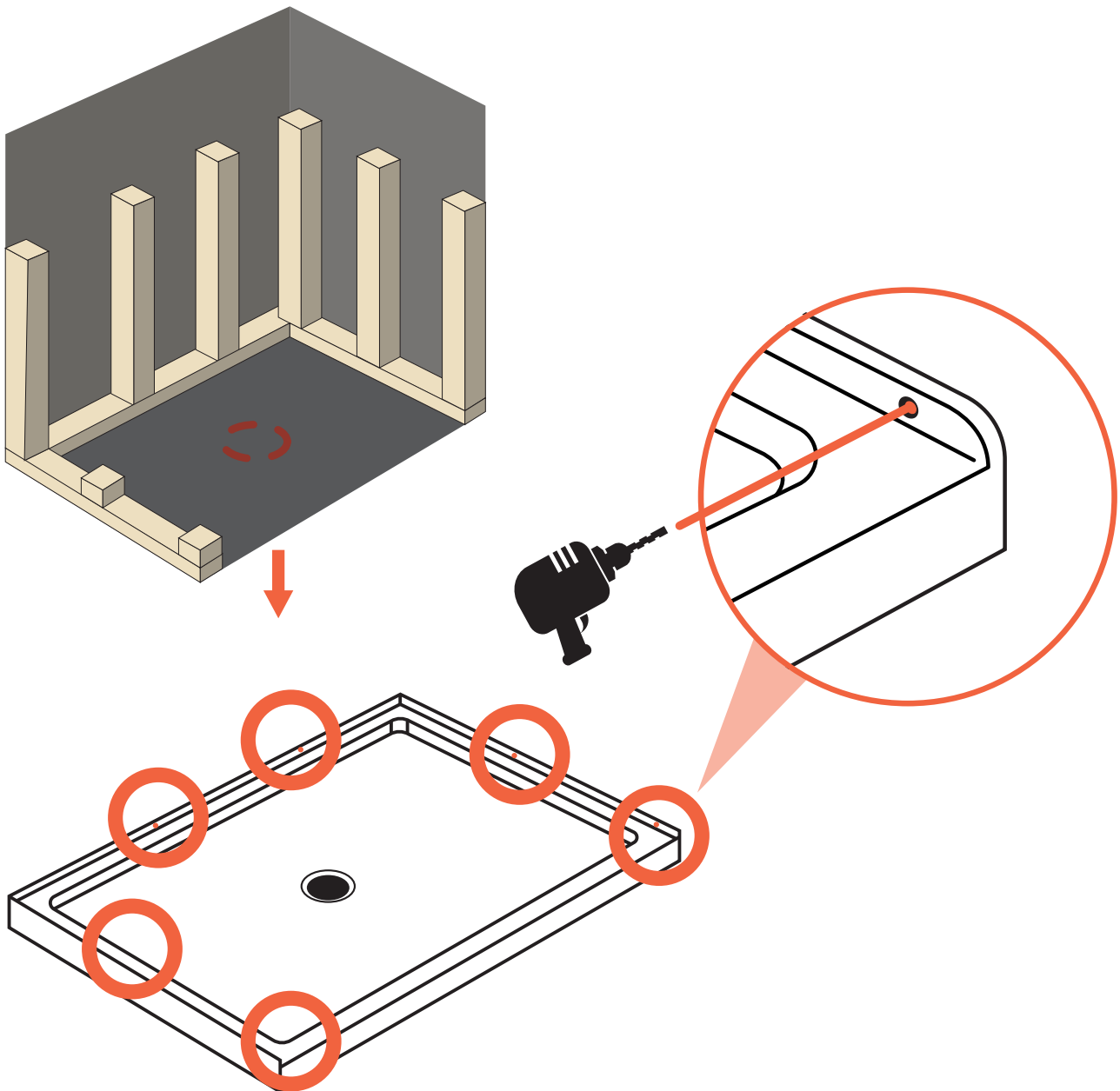

## Step 6

According to the mark of the drain location, make a 5"x 5" cutout opening on the subfloor. Ensure the 2" waste pipe is located centrally in the cutout and is raised at 1/2" to 1 3/4" above the floor.

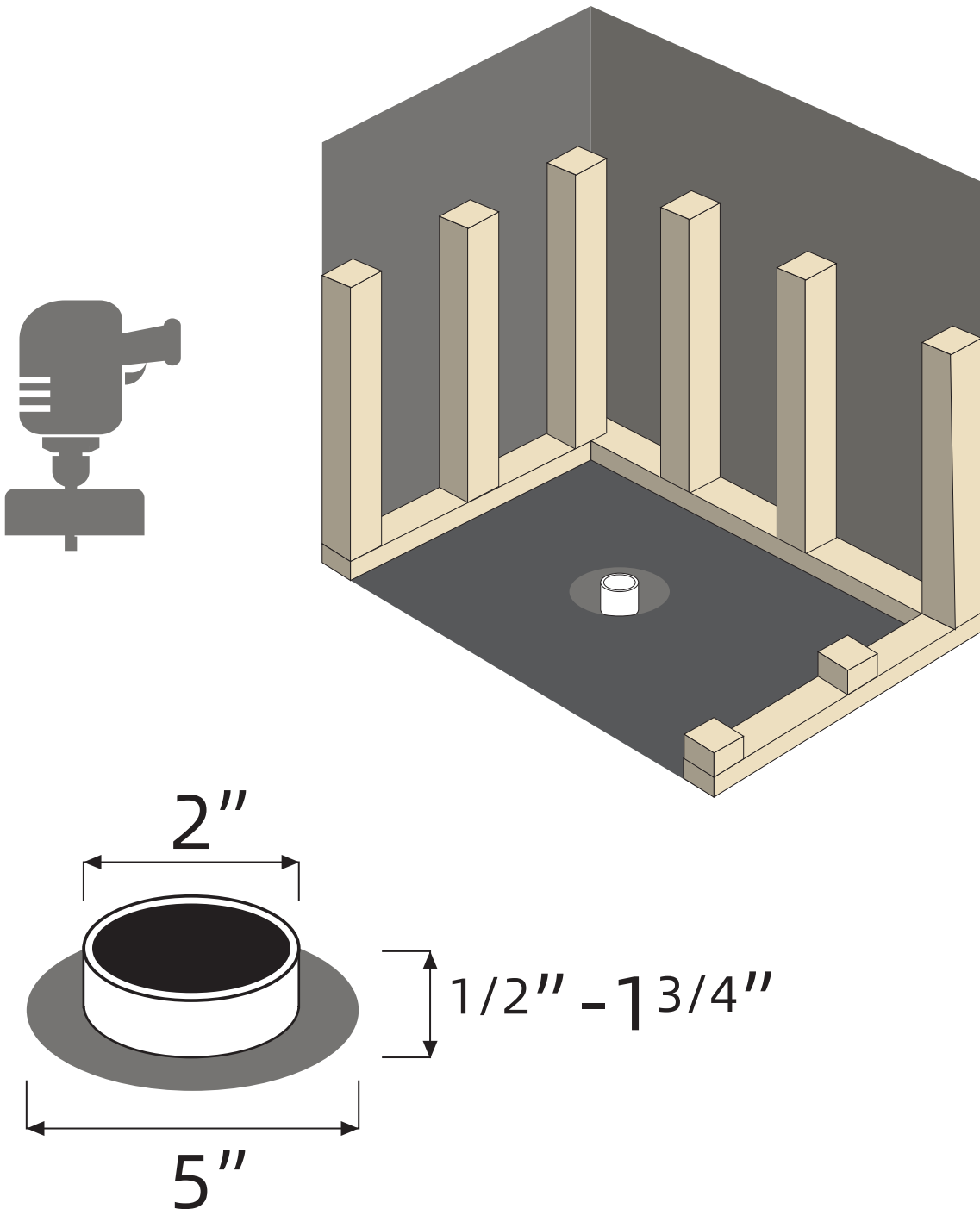

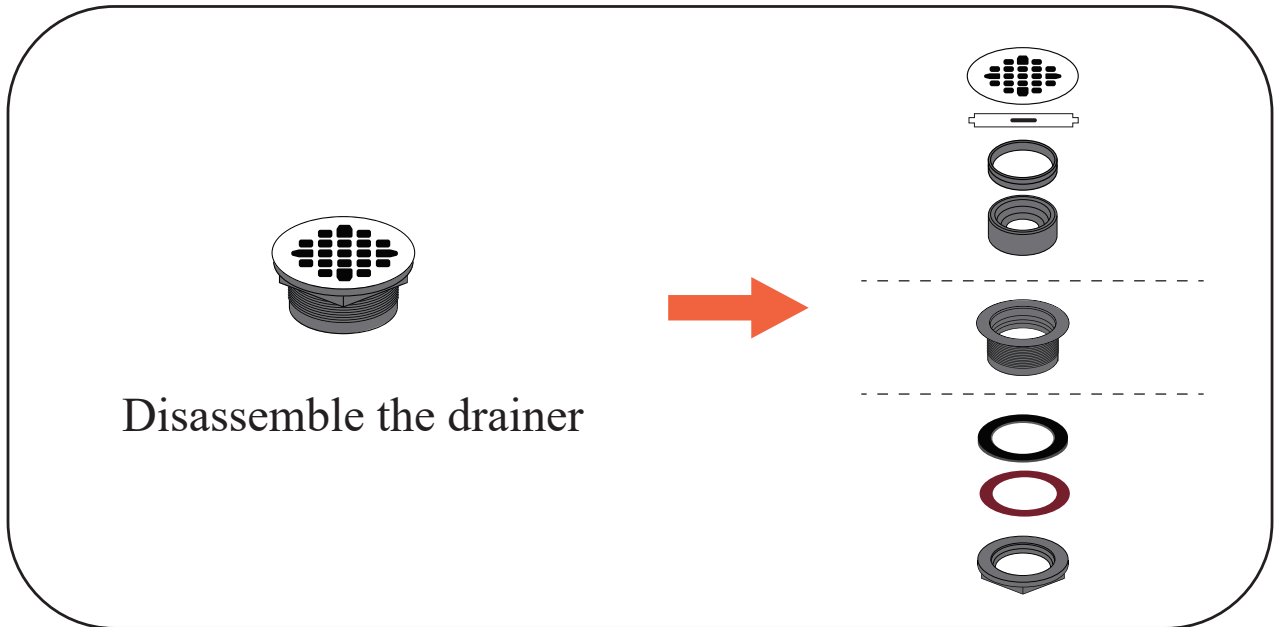

## Step7

According to the instructions, pre-install the drain assembly on the base. Apply plumber's putty under the drain flange before securing it to ensure a watertight seal

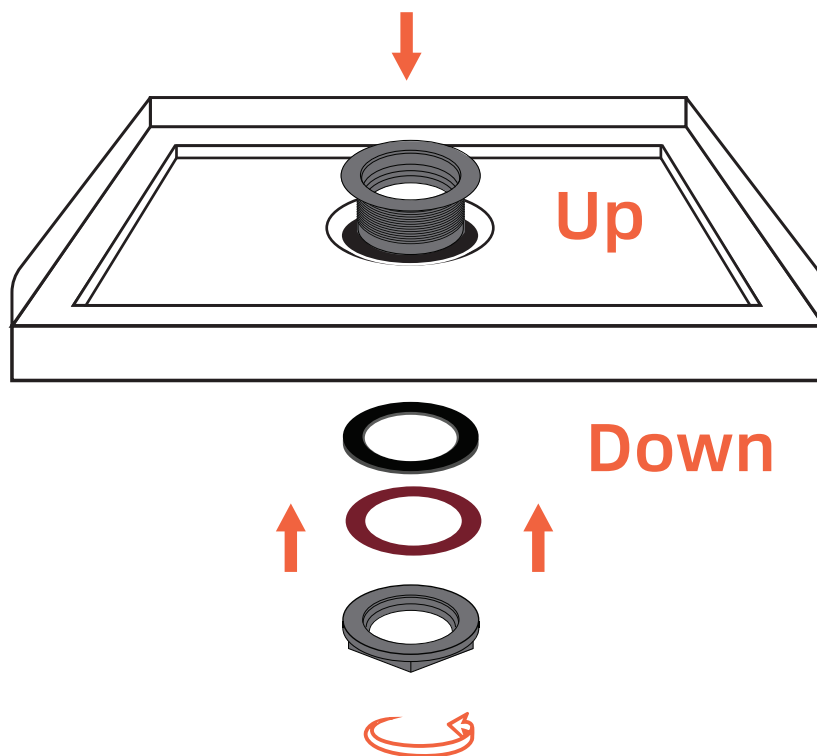

## Step 8

Place the shower base back into the installation location, and re-check to make sure that the drainpipe aligns with the actual shower base drain location.

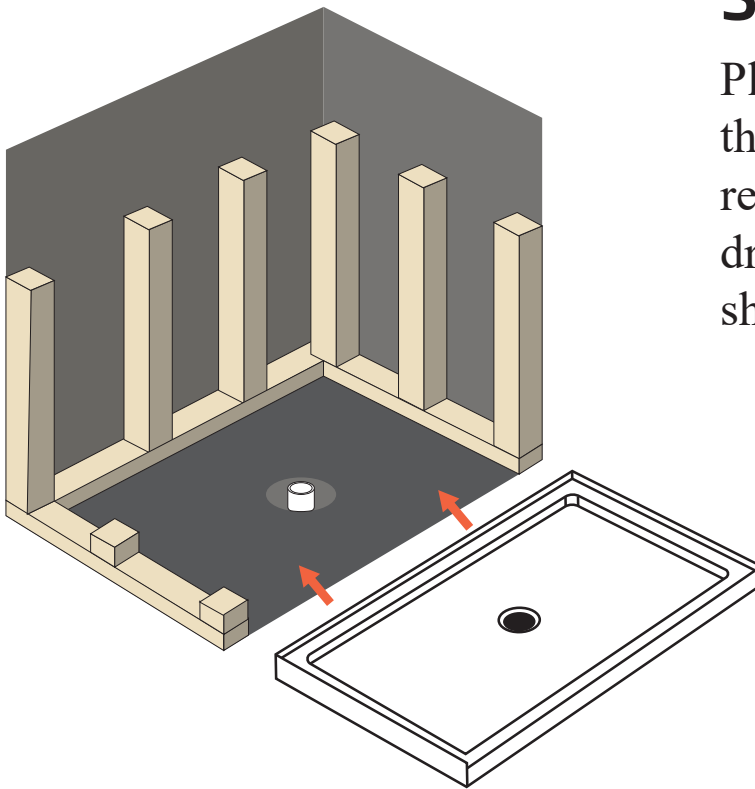

## Step 9

According to the instructions, insert the upper body and complete the drain install.

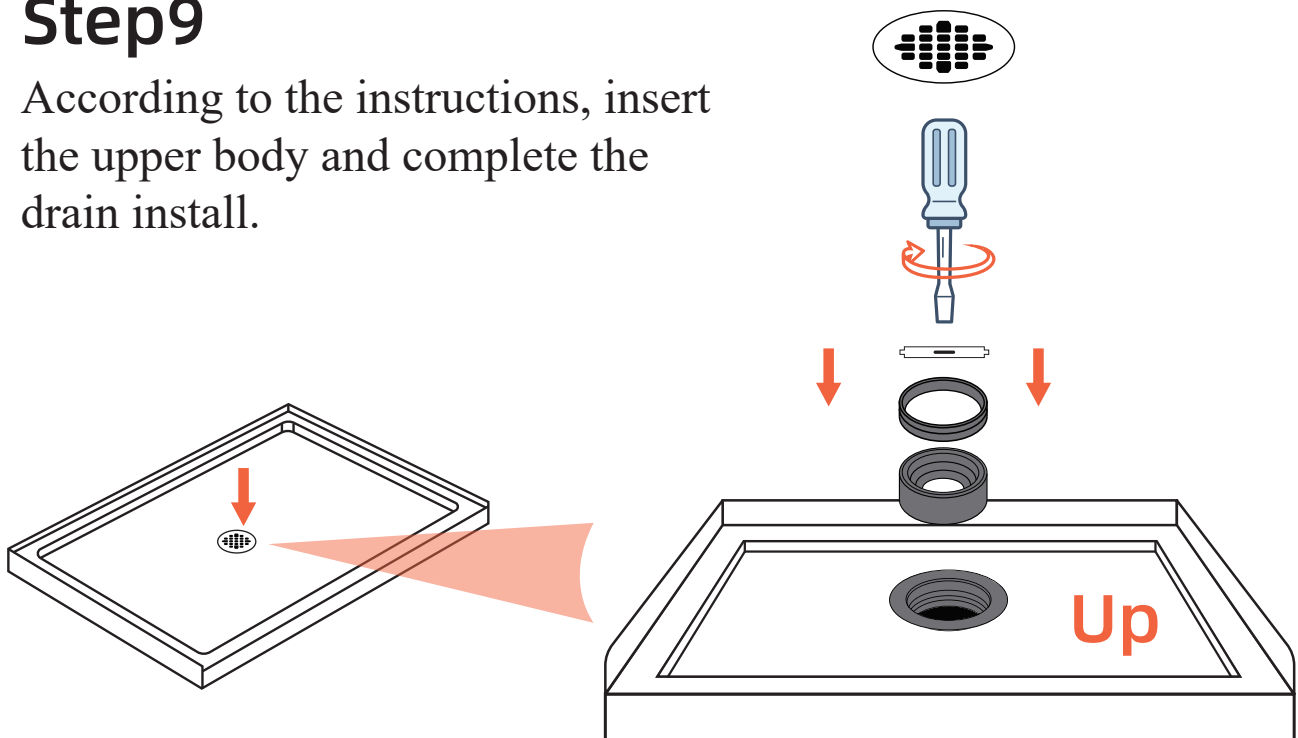

# Step 10

Apply a layer of thin-set mortar or construction adhesive to the area where the shower base will sit, use a notched trowel for even application.

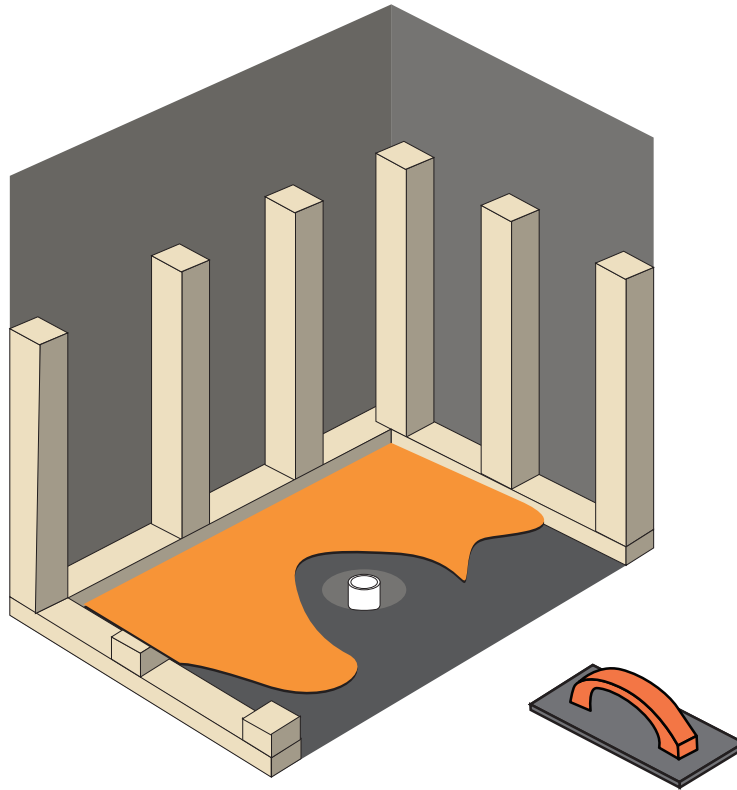

Make sure to avoid any contact between the adhesive and the drain during the installation process. Avoid applying adhesive within a 5-inch radius of the drain area.

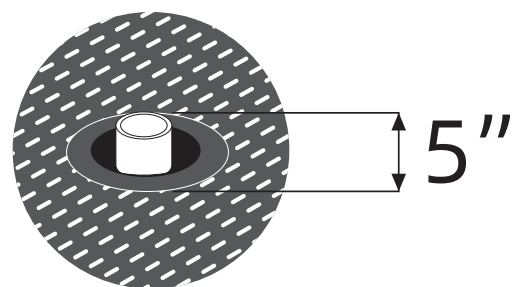
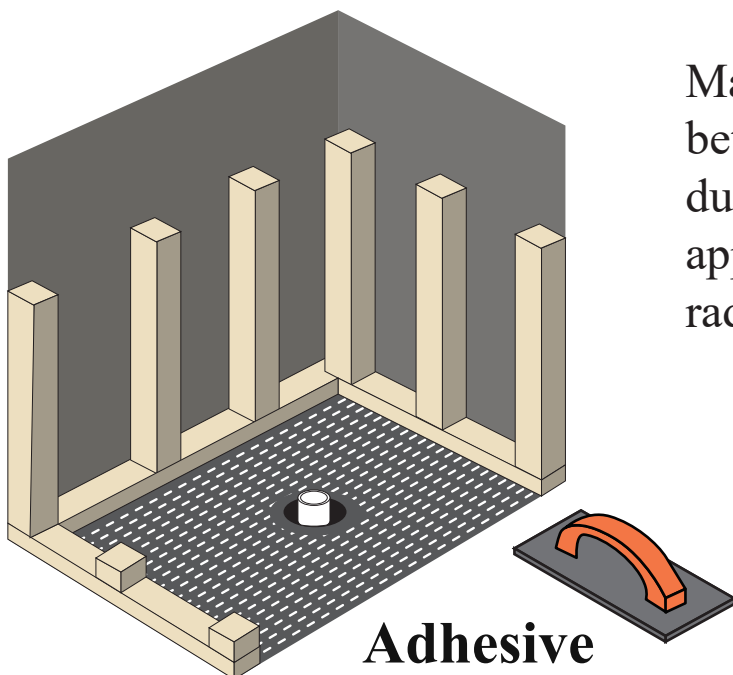

# Step 11

Carefully place the shower base onto the bedding material, pressing down firmly to ensure a good bond. Check again for levelness and adjust as needed. Connect the drain pipe beneath the floor to the drain assembly on the shower base. Ensure everything is properly aligned and tight to avoid leaks.

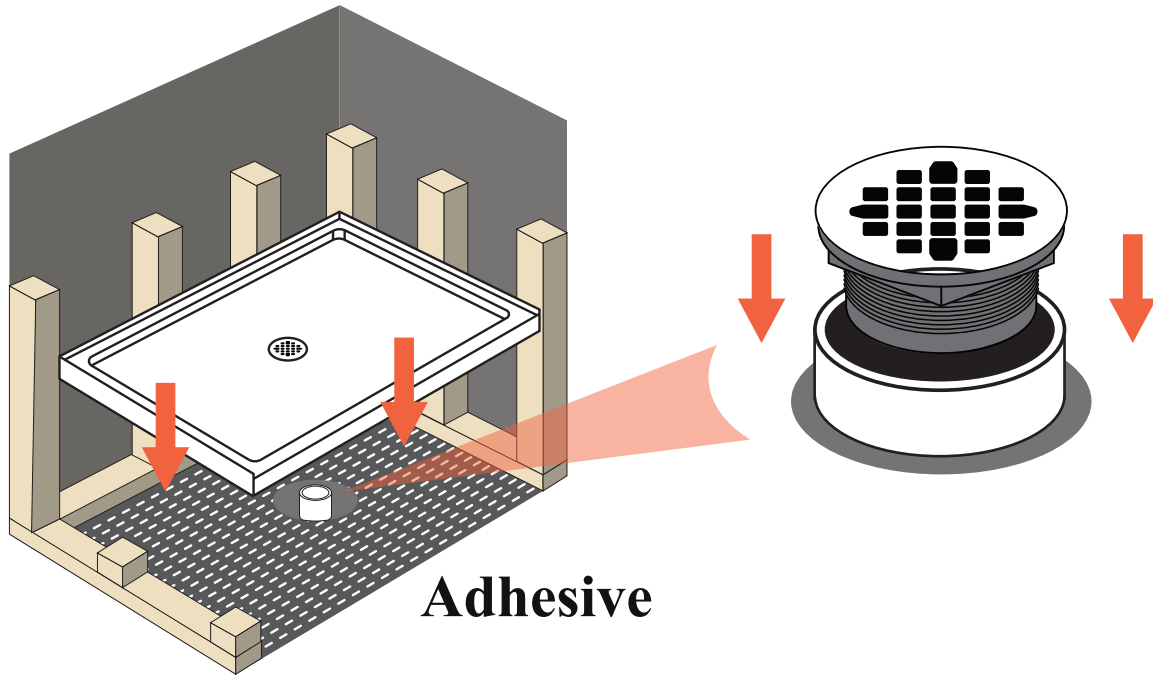

**Adhesive**

# Step 12

Use the level to check that the 4 sides of the shower base are leveled. Make sure all sides are leveled. You might need to adjust the subfloor if it wobbles or is not flat.

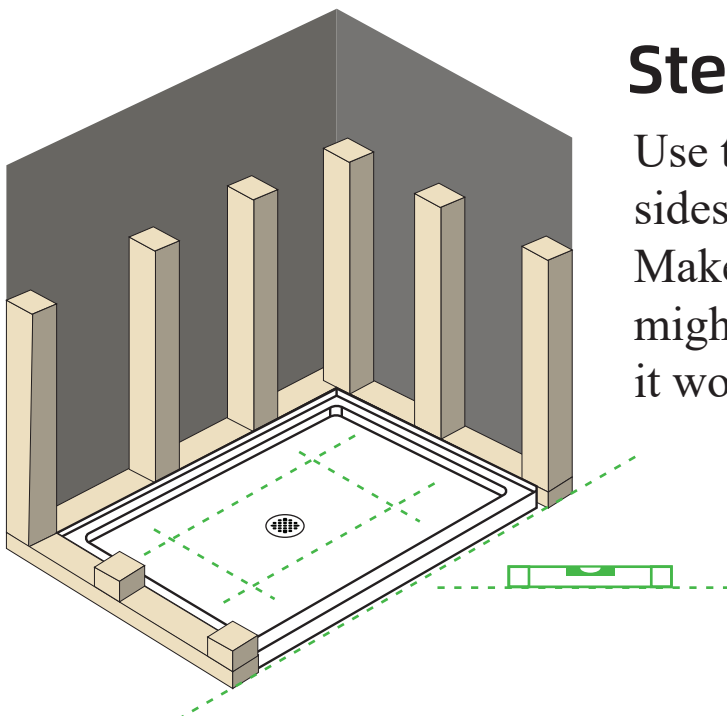

## Step13 Secure the base to the wall framing.

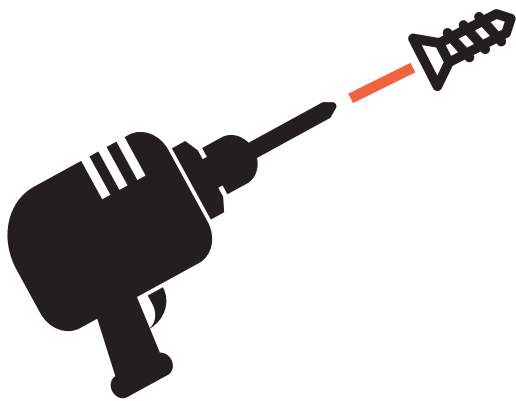
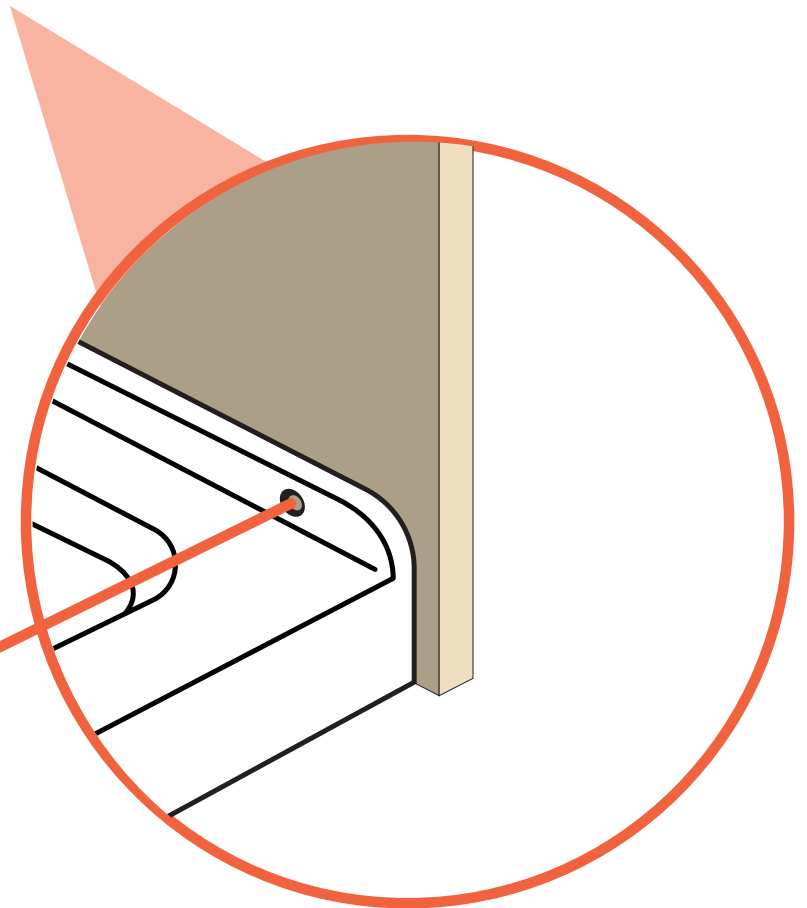
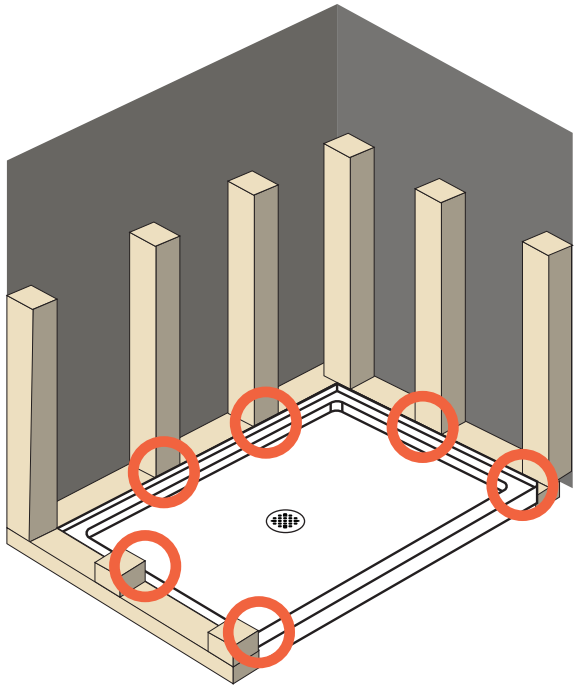

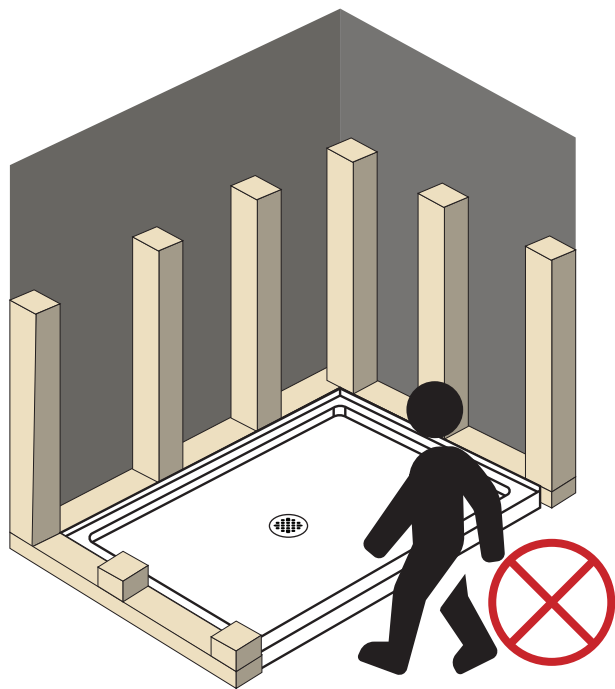

## Step14

Allow your shower base to cure for at least 24 hours or follow the drying and curing times recommended by the adhesive and caulk manufacturers before placing any weight on the bottom of the shower base.

 24 hours

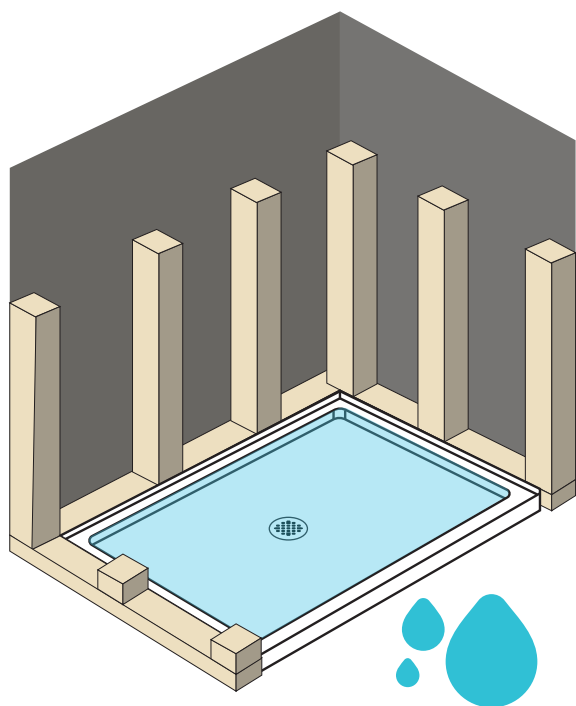

## Step15

Water test for the drain and plumbing, plugged the drain, fill the shower base with a few inches of water, and check underneath the base, especially around the drain and seams, for any signs of water leakage, after letting the water sit for 30 mins, unplug the drain and ensure water drains properly without any abstraction.

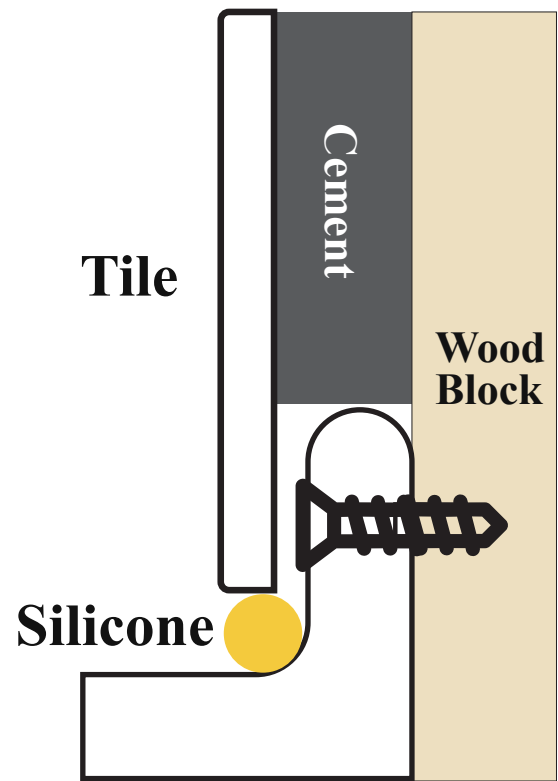
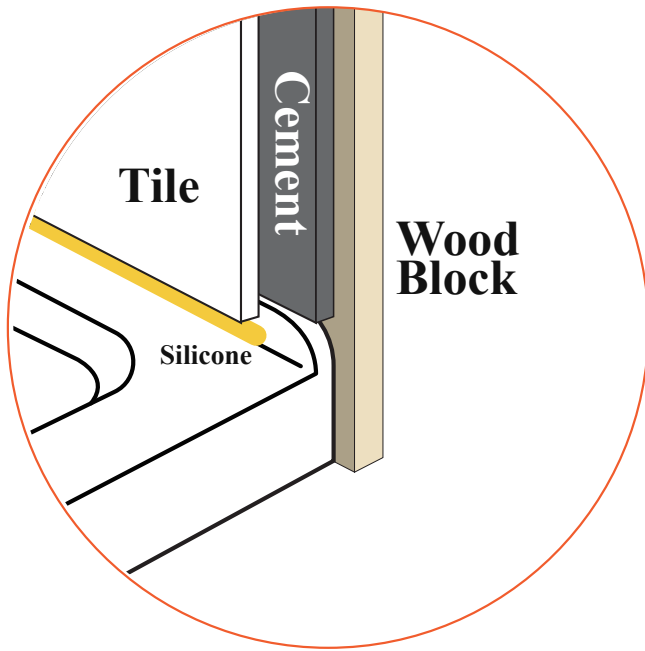

## Step 16

After the shower base has cured, you can proceed to install the shower walls, fixtures, and any additional accessories. Apply a silicone-based caulk around the edges of the shower base where it meets the wall to prevent water leakage.

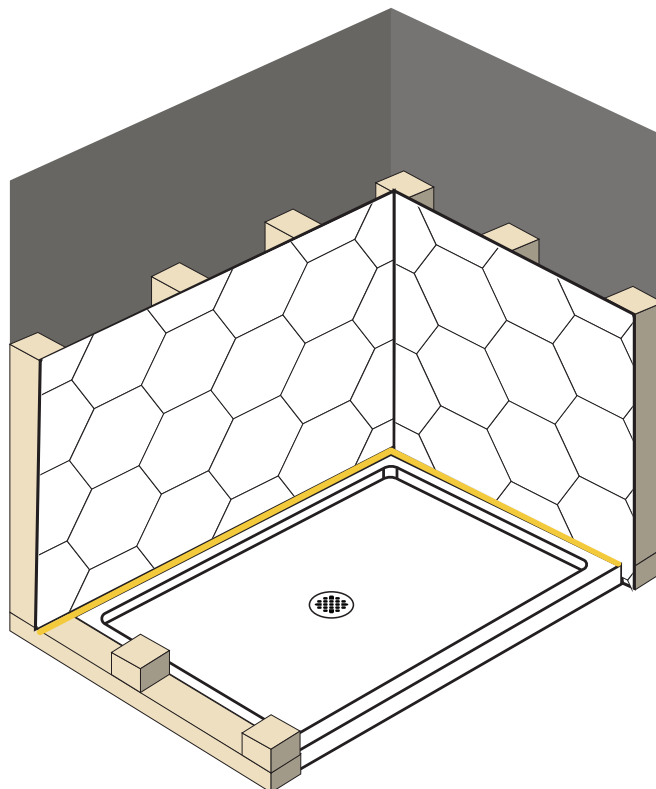

# Step17

Kindly Reminder: There is a transparent protective film on the base surface, please don't forget to tear it off before actual use.

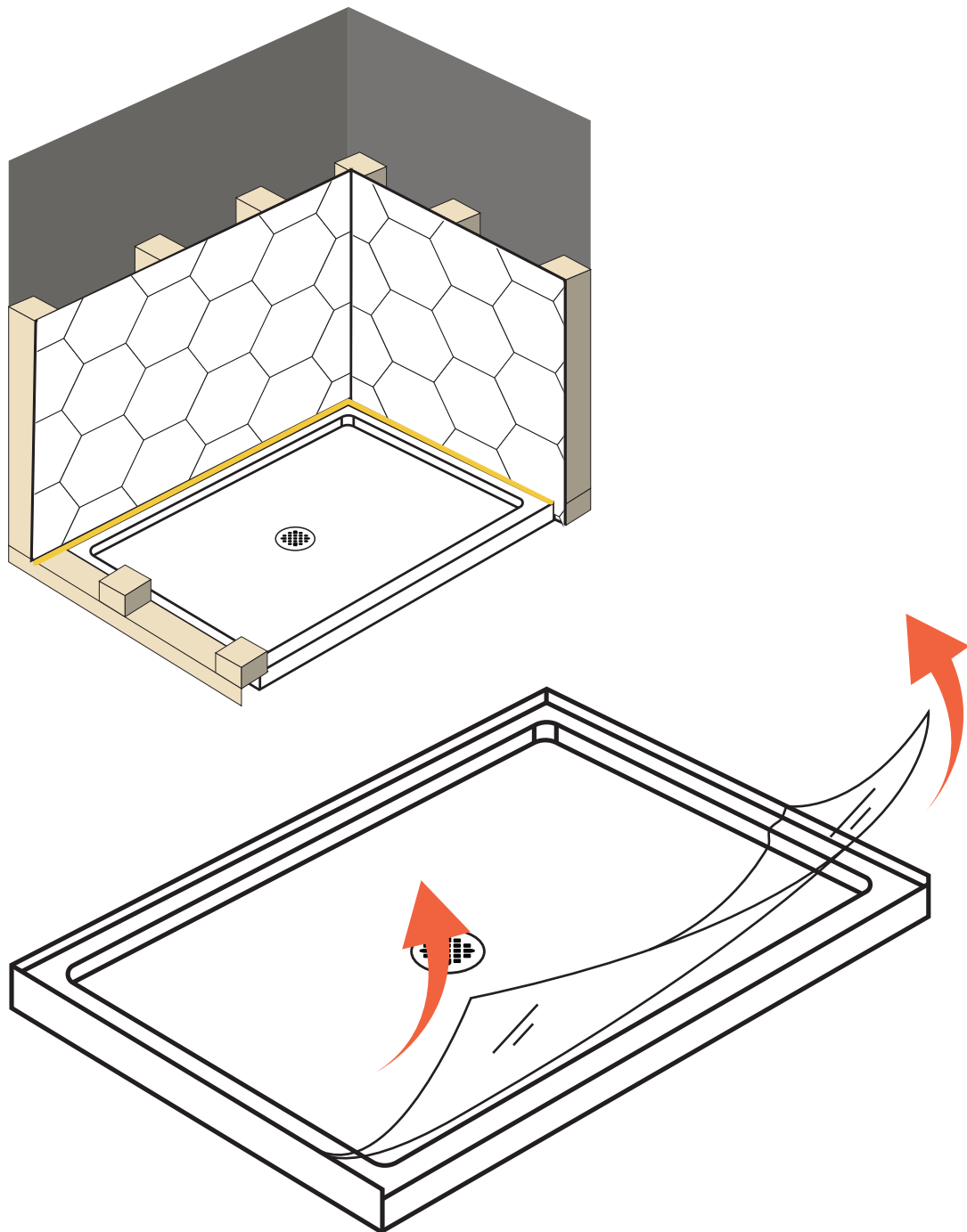

# CARE & MAINTACE

Maintaining an acrylic shower base is relatively easy and can help prolong its lifespan while keeping it looking good. Here are some effective maintenance tips:

## 1. Regular Cleaning:

- **Use Mild Cleaners:** Clean your acrylic shower base regularly with a mild, non-abrasive cleaner. Avoid harsh chemicals, bleach, or abrasive scrubbers, as these can scratch or damage the surface.
- **Soft Cloth or Sponge:** Use a soft cloth, sponge, or a non-abrasive scrub pad for cleaning. This will help prevent scratches while effectively removing soap scum and dirt.
- **Rinse After Use:** After each shower, rinse the base with warm water to remove any soap residue and prevent buildup.

## 2. Preventing Soap Scum and Hard Water Stains:

- **Squeegee After Use:** Use a squeegee to wipe down the walls and shower base after each use. This can help minimize water spots, soap scum, and mineral deposits.
- **Dry the Area:** After squeegeeing, use a soft towel to dry the surface if possible, reducing the moisture that promotes soap scum and mold.

## 3. Addressing Stains:

- **Baking Soda Paste:** For tough stains, create a paste with baking soda and water, apply it to the stain, let it sit for a few minutes, and then gently scrub with a soft cloth or sponge.
- **Vinegar Solution:** A mixture of equal parts water and white vinegar can help remove hard water stains. Spray the solution on the affected area, let it sit for a few minutes, then rinse and wipe clean.

#### 4. Avoiding Damage:

- **No Abrasive Tools:** Avoid using steel wool or harsh scrubbing pads, as they can scratch the acrylic surface.
- **Hot Items:** Never place hot items directly on the acrylic surface, as extreme heat can cause warping or damage.
- **Avoid Heavy Impacts:** Be cautious not to drop heavy objects onto the shower base, as this can cause cracks or dents.

#### 5. Check for Cracks or Damage:

- **Regular Inspections:** Periodically inspect the shower base for any signs of cracks, chips, or discoloration. If you notice damage, address it promptly to prevent further issues.
- **Repair Kits:** If you find a small crack or chip, consider using an acrylic repair kit specifically designed for fixing minor damage to acrylic surfaces.

#### 6. Maintain Surrounding Areas:

- **Seal Grout Joints:** If your shower base is part of an enclosed unit with tile walls, make sure the grout joints are sealed to prevent moisture from seeping behind and causing damage.
- **Check Caulking:** Regularly inspect the caulking around the shower base. If you notice it cracking or peeling, remove the old caulk and reapply new silicone caulk to prevent water leakage.

#### 7. Use a Shower Mat:

- **Non-Slip Mat:** Consider using a non-slip shower mat or rug in your shower to protect the base from scratches and provide added traction.

#### 8. Avoiding Heavy Cleaning:

- **Limit Strong Chemicals:** Avoid using harsh chemicals, bleaches, or products containing alcohol or ammonia, as these can degrade the acrylic over time.

# LIMITED WARRANTY COVERAGE

## 1 YEARS LIMITED WARRANTY

GETPRO products are made with quality materials and excellent craftsmanship to provide the customers a long-lasting product. In the case of any defects in materials or craftsmanship under regular use were inspected in the first one year of delivery, GETPRO will provide replacement parts at no charge, or at its option, replace any product or part of the product that is deemed defective, under normal installation, use, service and maintenance. This warranty applies only to the original purchaser. Proof of purchase will be required in the case of a claim.

## GETPRO will, as its option

- (1) Repair or replace the defective part(s) or product(s) at no charge;
- (2) Issue a refund of the original purchase price of the product(s) (Valid within 30 days from the date of delivery);
- (3) Issue a credit to be applied toward the purchase of a new GETPRO product shipping/delivery charges may apply and are in GETPRO's sole discretion.

GETPRO recommends the installations to be made by a licensed, professional plumber. GETPRO will not be held responsible for any damage or product failure due to improper installation, misuse, or failure to use a licensed professional. GETPRO is not responsible for any removal or installation cost.

This limited warranty shall not apply to goods that have been subject to accident, negligence, improper installation, product abuse, product misuse, or use of cleaners containing abrasives, alcohol or other organic solvents, whether performed by a contractor, service company, or yourself, are excluded from this warranty.

GETPRO responsibility under this limited warranty is limited to only to replacement parts and no other costs.

GETPRO will not be responsible for labor charges and/or damage incurred by installation, repair, or replacement, nor for any indirect incidental or consequential damages, losses, injury, or costs of any nature relating to this product.

Except as provided by law, this limited warranty is instead of and excludes all other warranties, conditions, and guarantees, whether expressed or implied, statutory or otherwise, including without restriction those merchant ability of fitness for use.

## RESPONSIBILITIES OF OTHERS

Inspecting the unit before installation is the responsibility of the installer or building contractor who acts on behalf of the user. They are responsible for ensuring the unit is free of defects or damage.

Notices are placed on and in the unit and on the shipping carton advising the installer of this responsibility. In the event of a problem, the unit must not be installed.

GETPRO is not responsible for failures or damage that could have been discovered, repaired, or avoided by proper inspection and testing before installation.

Damage occurring in transit is the responsibility of the carrier. The user or installer **MUST** open the crate and inspect the unit for damage when it's delivered. If damage is discovered, it must be reported immediately to the seller and the carrier in writing, and an inspection requested. Failure of the carrier to respond should be reported to the seller and the carrier. Your freight claims should be filed promptly thereafter.

## LIMITATIONS AND EXCLUSIONS

This warranty does not cover instances of negligence, misuse, abuse, improper installation, carelessness, accident, hard water or mineral deposits, exposure to corrosive materials, misapplication, damages caused by improper maintenance, alteration of the product, or failure to follow care or installation instructions enclosed with your product.

This warranty is void if the GETPRO is subject to alteration, or if repairs are attempted by anyone other than an authorized agent of GETPRO. This warranty does not extend to plumbing or components installed by dealers, installers or by any party other GETPRO.

GETPRO will not be liable for loss of use of the GETPRO inconvenience, or any other incidental or consequential costs, expenses, or damages. Please note that some states do not allow the exclusion or limitation of incidental damages.

## DISCLAIMER

Except as expressly provided, there shall be no warranty or obligation, express or implied, oral or statutory. No dealer or other person has the authority to make any warranties or representations concerning GETPRO or its products. In no event shall GETPRO be held responsible for any such warranties or representations.

## WARRANTY SERVICE

NOTE: When requesting a warranty, be sure to have the following:

- Copy of original invoice
- Date of installation
- Description and pictures of the defect
- Model number or description of the model

To obtain warranty service and replacement parts, please contact GETPRO Customer Service. GETPRO will determine whether to repair or replace your product, issue a refund, or issue a credit.

WARNING: Content may contain sharp and other possibly harmful pieces and may cause hazard to children and adults, GETPRO is not responsible in any way for personal damage.

# HOME SERVICES



INSTALLATION VIDEO

**Missing Part or Defective?**

Please Contact the Customer Service Team

 626-679-3588

 [service@getprohome.com](mailto:service@getprohome.com)