

ASSEMBLY INSTRUCTIONS

RECLINER

Step 1:





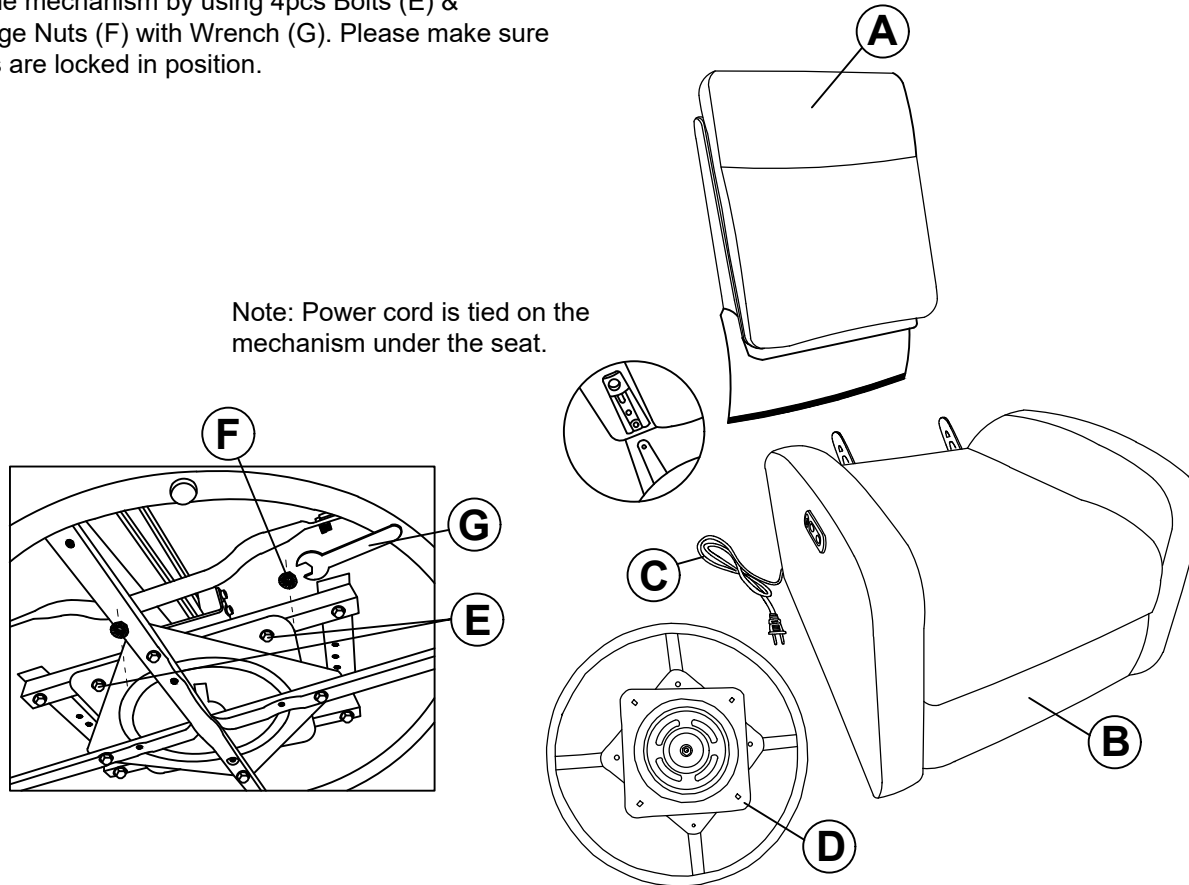

Parts included listed on the right.

Step 2:

Attach the Swivel Base (D) to Seat (B) by aligning the mechanism by using 4pcs Bolts (E) & 4pcs Flange Nuts (F) with Wrench (G). Please make sure both sides are locked in position.

Note: Power cord is tied on the mechanism under the seat.

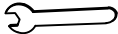

PARTS LIST:		Picture	QTY
A	BACK		1
B	SEAT		1
C	Power Cord (Pre-attached)		1
D	Swivel Base		1
E	Bolt 1/4"		4
F	Flange Nuts		4
G	Wrench		1

Step 3:

Attach the Back (A) to the Base frame (B) by aligning the mechanism receivers with the mechanism post as seen at the left. After aligning both sides, push firmly in a downward motion until you hear a clicking noise. The noise indicates the back is locked to the base frame. Please make sure both sides are locked in position. Attach the outside back along the bottom rear of the base frame with the pre attached velcro.

Step 4:

Connect the power cord to a power source.

Note:

- 1: To help prevent shock and or damage to your product only plug the power cord into a grounded outlet.
- 2: Do not plug the power source into a power outlet until your product is completely assembled and positioned where you intend to use it.

Caution:

Read the Operating Instructions supplied before operating your power mechanized equipment.
Do not allow children to play on or operate this power mechanized equipment.