

NOTICE

- * Please make sure that you have all parts indicated and they are in good condition before you begin assembly of this item. Refer to part list and hardware list below for guidance.
- * This item should be assembled on a soft surface to prevent scratching the finish during assembly.
- * This item may require periodic tightening.
- * If you are having difficulty, our friendly Customer Care team is always here to help. Please

PREPARATION

- * Before beginning assembly of product, make sure all parts are present. Compare parts with part contents list and hardware contents list.
- * If any part is missing or damaged, do not attempt to assemble the product.
- * Estimated Assembly Time: 15 minutes.
- * Tools Required for Assembly: Allen key (included) and screw driver (not included).

CARE AND MAINTENANCE

* Adhesive felt pads should always be applied to areas of furniture which make direct contact with flooring, said application will prevent damage to the furniture and or surfaces on which the furniture lies. Objects placed on articles of furniture should rest on non abrasive material as to prevent damage to the wood finish. Objects whose composition consists of plastic and rubber are known to discolor and damage the wood surfaces on which they rest. Wipe up spills immediately and avoid common hazards such as hot dishes, harsh solvents and abrasives. Cleaning should be done with a soft lint free cotton cloth dampened with water or furniture polish. On highly used surfaces we recommend applying a quality paste wax which should be used on a regular basis to provide additional protection from scratches and spills. How often you apply the wax depends on how much wear the furniture receives.

Product Dimensions: 17.3" W x 23.1" D x 41.7"H

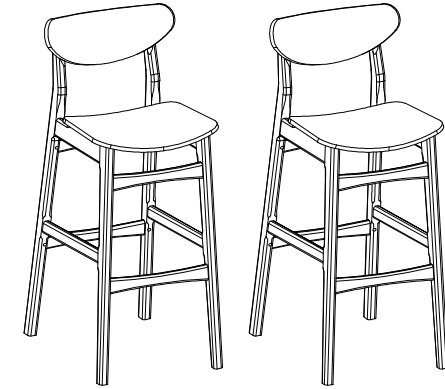





! WARNING !



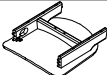
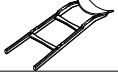

Weight capacity: 275 LBS

Warning: Do not stand on Chair

Warning: Do not over torque Bolts

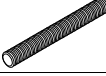
Part List and Hardware List

PIECE	DESCRIPTION	PICTURE	QUANTITY
A	Chair Seat		2X
B	Chair Back		2X
C	Front Leg		2X
D	Side Bar		4X
HW1	Barrel Nut M6x1.0xØ10x45mm		4X
HW2	Socket bolts M6x1.0x80mm		8X

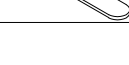
HW3	Headless Bolts M8x1.25x70mm		4X
HW4	Semicircle Washer 8x15x30mm		4X
HW5	Jam 8mm		4X
HW6	Phillips Screws 4x50mm		8X
HW7	Allen Key		1X
HW8	Spanner		1X

PREPARATION

- * Before beginning assembly of product, make sure all parts are present. Compare parts with part contents list and hardware contents list.
- * If any part is missing or damaged, do not attempt to assemble the product.
- * Estimated Assembly Time: 15 minutes.
- * Tools Required for Assembly: Allen key (included) and screw driver (not included).
- * If you are having difficulty, our friendly Customer Care team is always here to help.

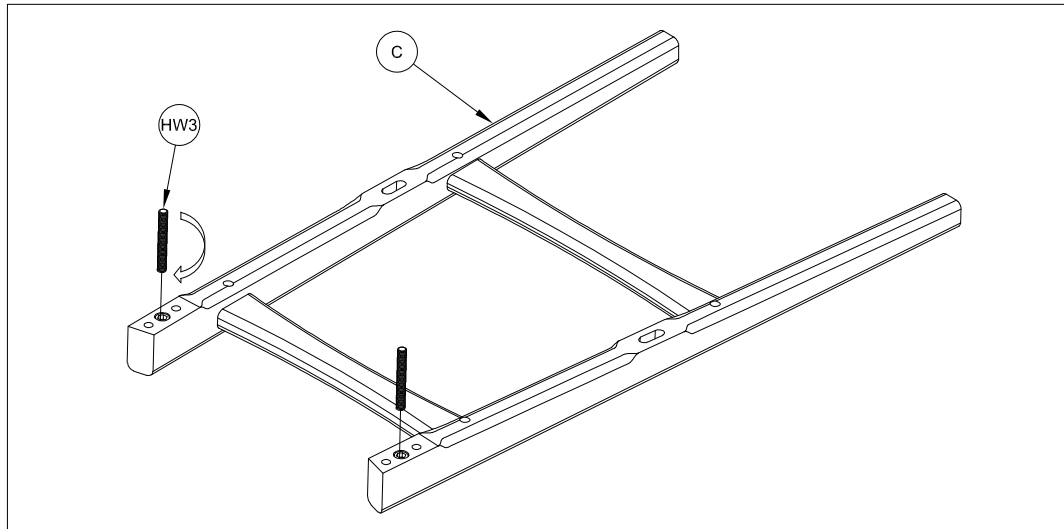

STEP 1: Attach the headless bolts to the front leg part.

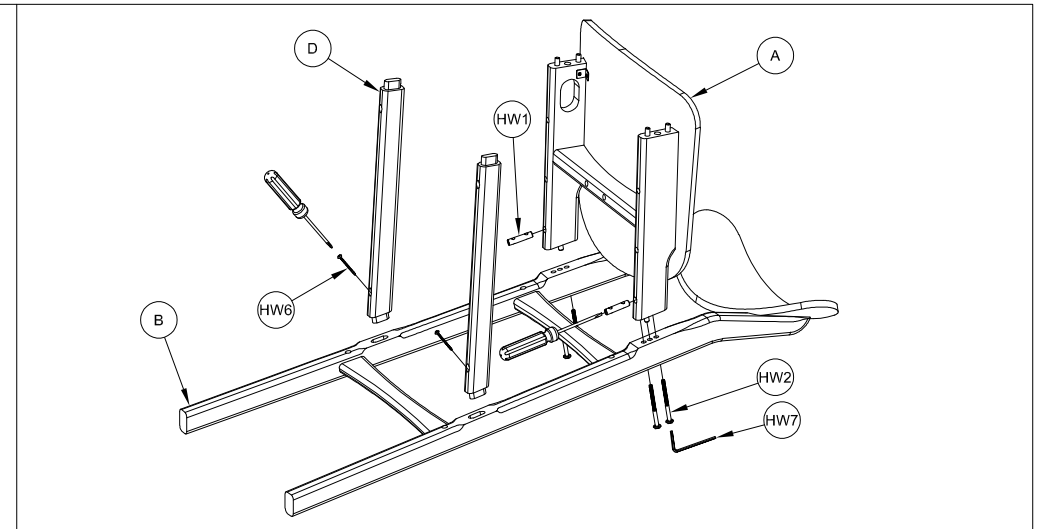

STEP 2: Assemble the seat to the back leg part. Make sure to apply all the bolt into the holes properly before tightening.

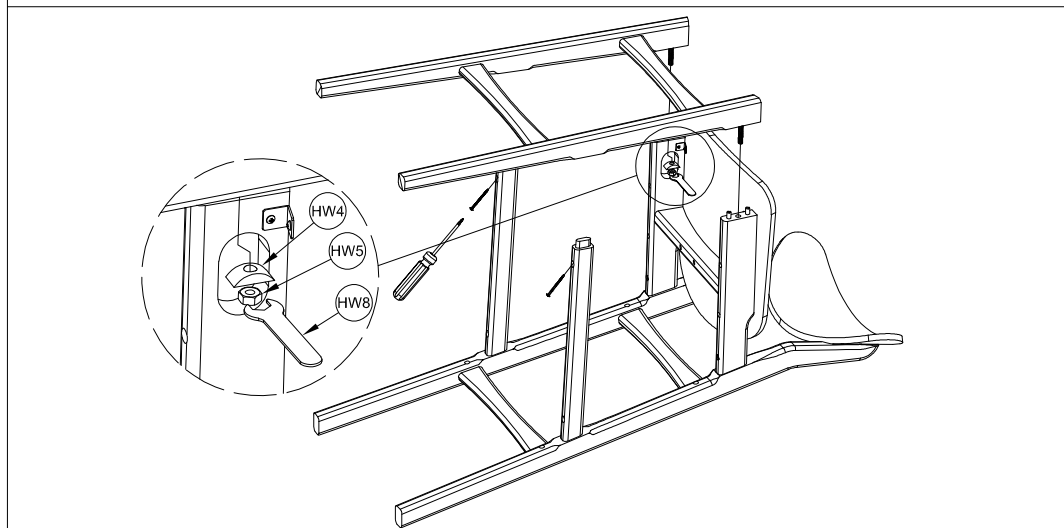

STEP 3: Assemble the front leg to the seat. Apply all the bolt, semicircle washer, and the nut into the holes properly, make sure the chair don't wobble before tightening.