

BATHROOM CABINET INSTRUCTION

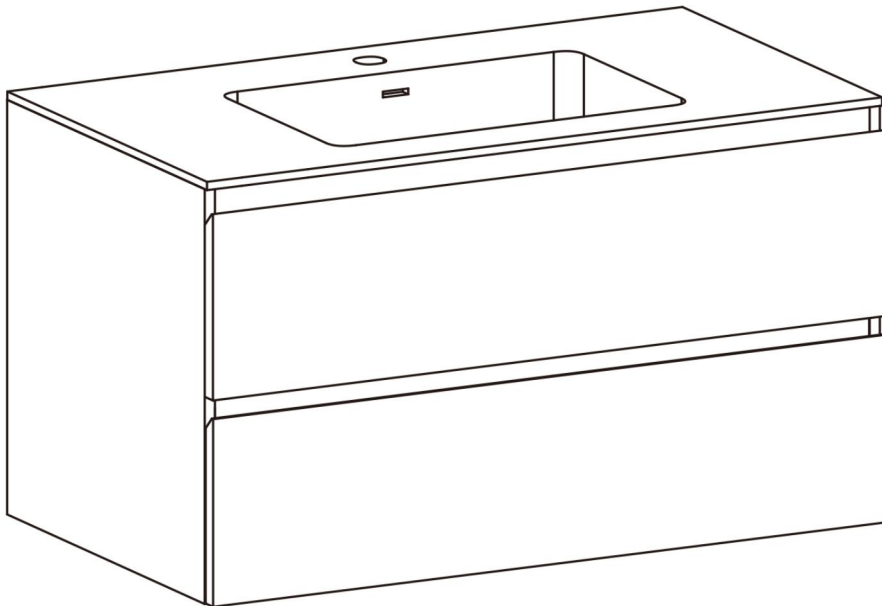

This instruction must be given to the user.

Guarantee/Liability only when assembled by an approved specialist in accordance with the instructions and local regulations.

BEFORE YOU BEGIN

- Please read these instructions carefully to familiarize yourself with the required tools, materials, and installation sequences. Follow the sections that pertain to your particular installation. This will help you avoid costly mistakes. In addition to proper installation, read all operating and safety instructions.
- All information in these instructions is based upon the latest product information available at the time of publication. We reserves the right to make changes in product characteristics, packaging, or availability at any time without notice.
- These instructions contain important care and cleaning, please leave instructions for the consumer.
- This product complies with GB 24977-2010.

SAFETY WARNINGS

The products are precision-engineered and should give continued superior and safe performance, provided:

1. They are installed, commissioned, operated and maintained in accordance with the recommendations given in this Manual.
 2. Periodic attention is given, as necessary, to maintain the product in good functional order. Carefully inspect the new fixture for any signs of damage.
- When installing Products, manufacturers guidelines for power tool safety should be followed.

TOOLS LIST

TOOLS AND MATERIALS REQUIRED (Not supplied)



Drill



φ8

Drill bit

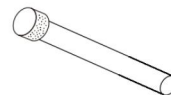

φ8

Glass drill

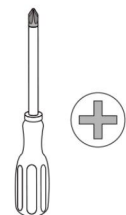

Screwdriver



Spirit level



Ruler



Pencil



Silicon sealant

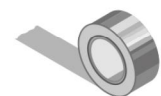



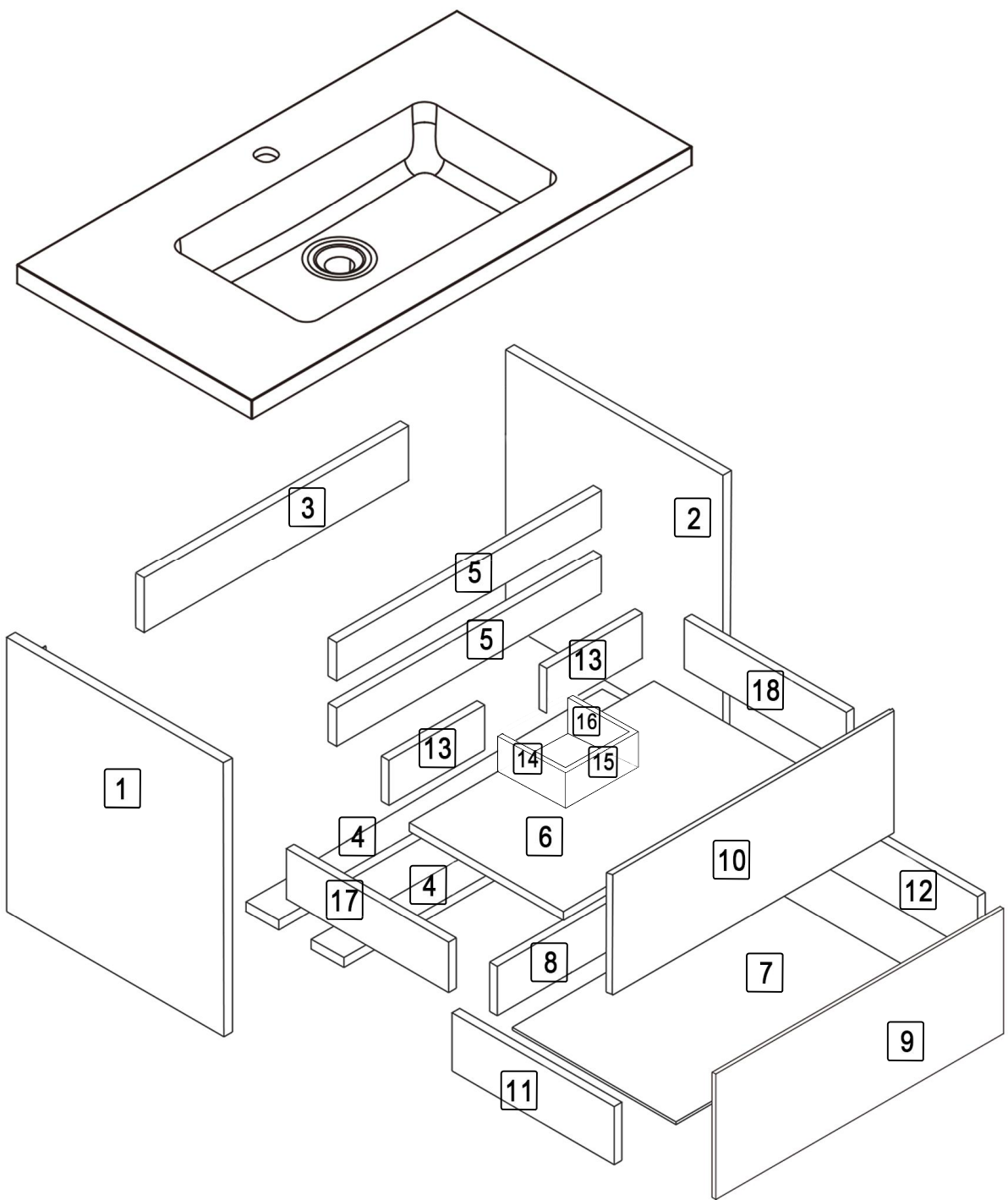





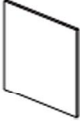

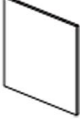

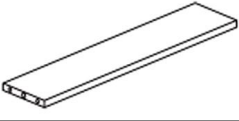

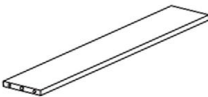
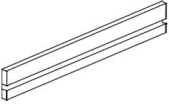
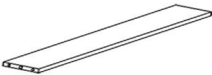
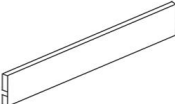
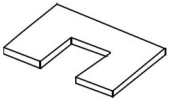

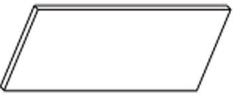
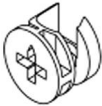
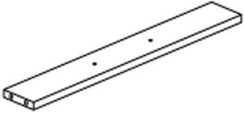

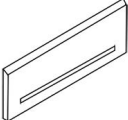
Masking tape

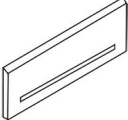

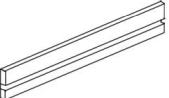
PARTS LIST

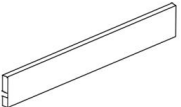
PARTS LIST

NO.	DESCRIPTION	QTY	NO.	DESCRIPTION	QTY
1		1	14		1
2		1	15		1
3		1	16		1
4		2	17		1
5		2	18		1
6		1	19		4
7		1	20	 CAM LOCK	54
8		1	21	 CAM SCREW	54
9		1	22	 (4 X 14mm)	32
10		1	23	 (M6 X 65mm)	2
11		1	24	 (M6 X 35mm)	2
12		1	25		2
13		2			

INSTALLATIONS

STEP 1

HARDWARE LIST	
21	20PCS

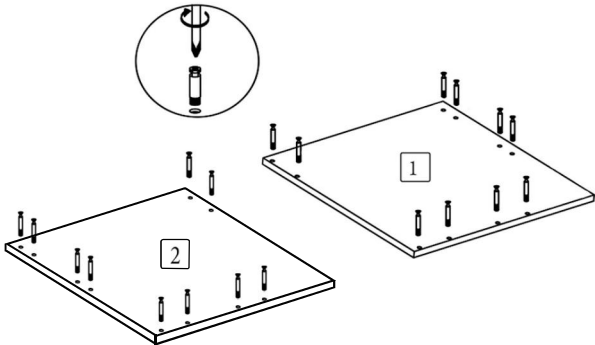

● Insert the cam screw into the shelves above.

STEP 2

HARDWARE LIST	
19	4PCS

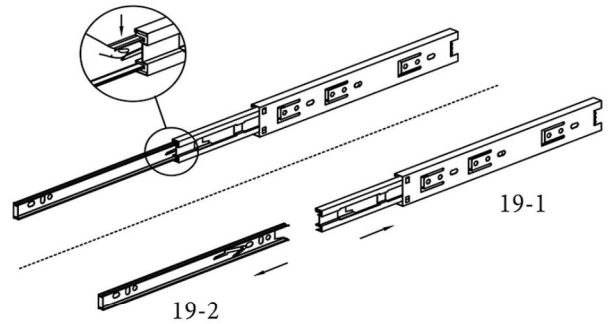

● Press the button and extend the slide slowly, then separate it with the release latch. Repeat these steps for the other slides.

STEP 3

HARDWARE LIST	
19	4PCS
22	8PCS

19-1 x 4

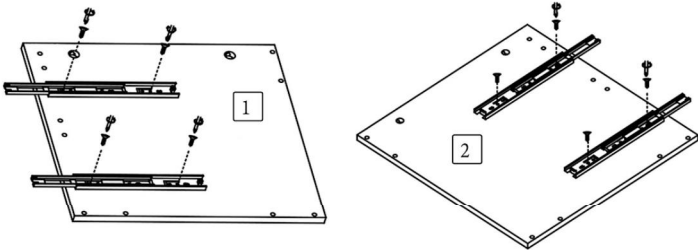

STEP 4

HARDWARE LIST	
20	10PCS

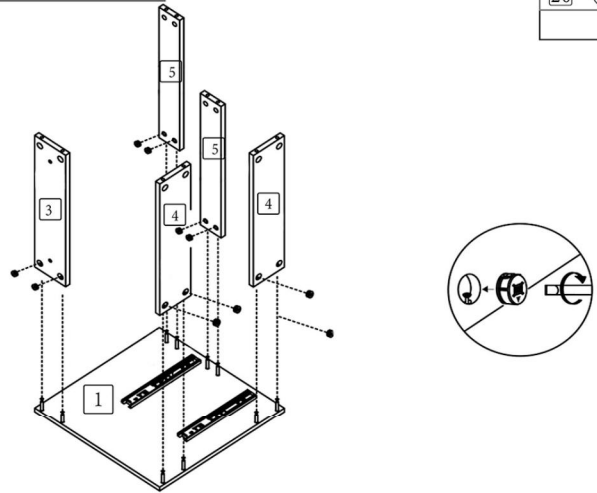

STEP 5

HARDWARE LIST	
20	10PCS

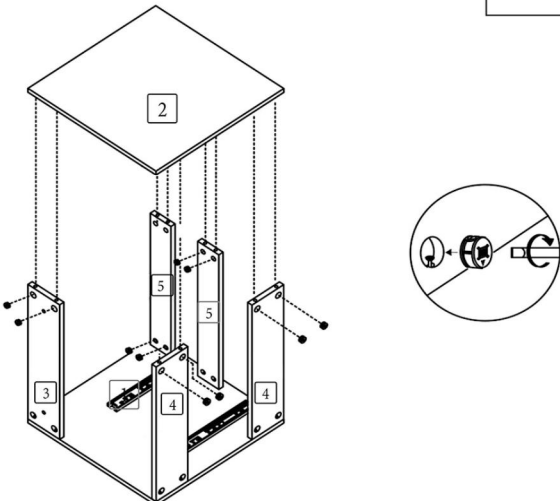

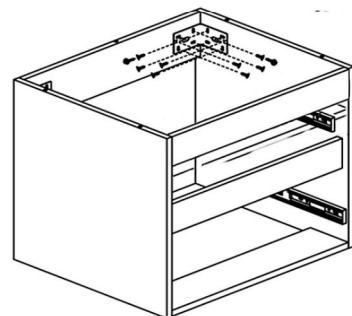

STEP 6

HARDWARE LIST	
25	2PCS
22	16PCS



STEP 7

HARDWARE LIST		
20		34PCS
21		34PCS

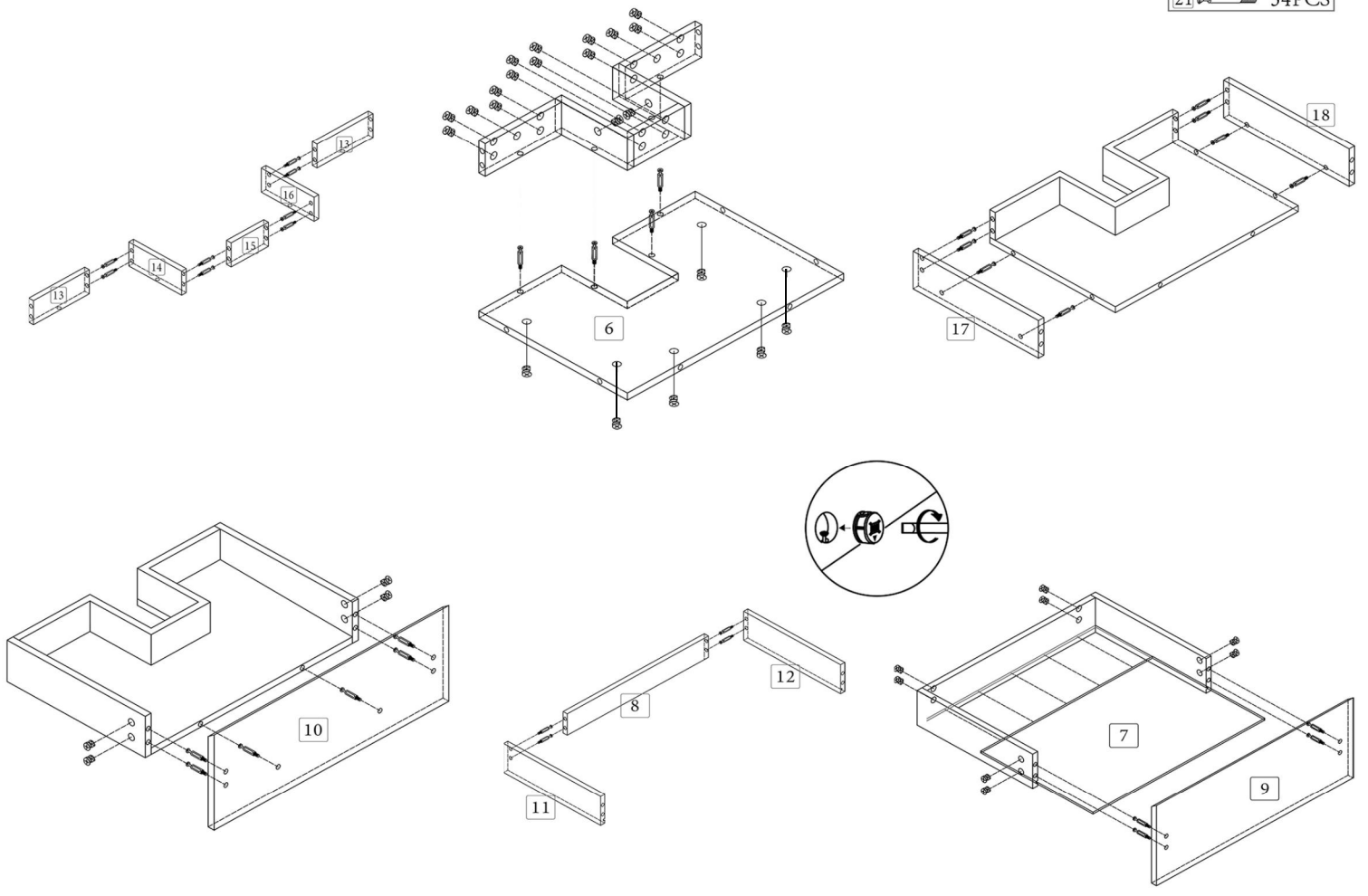

STEP 8

HARDWARE LIST		
19-2		4PCS
22		8PCS

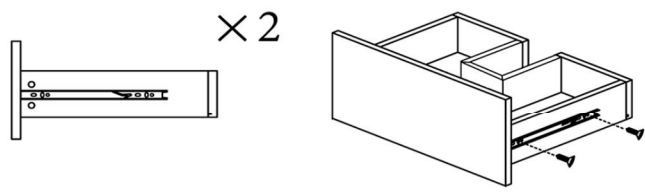

STEP 9

HARDWARE LIST		
23		2PCS

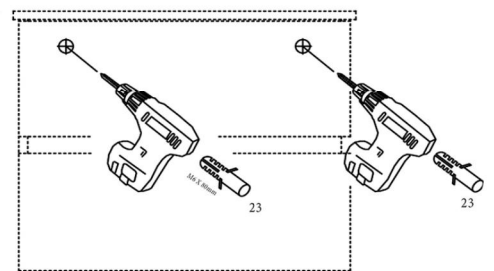

STEP 10

HARDWARE LIST		
		2PCS

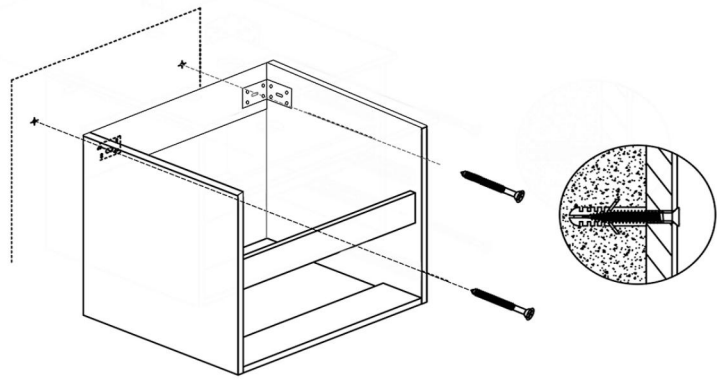



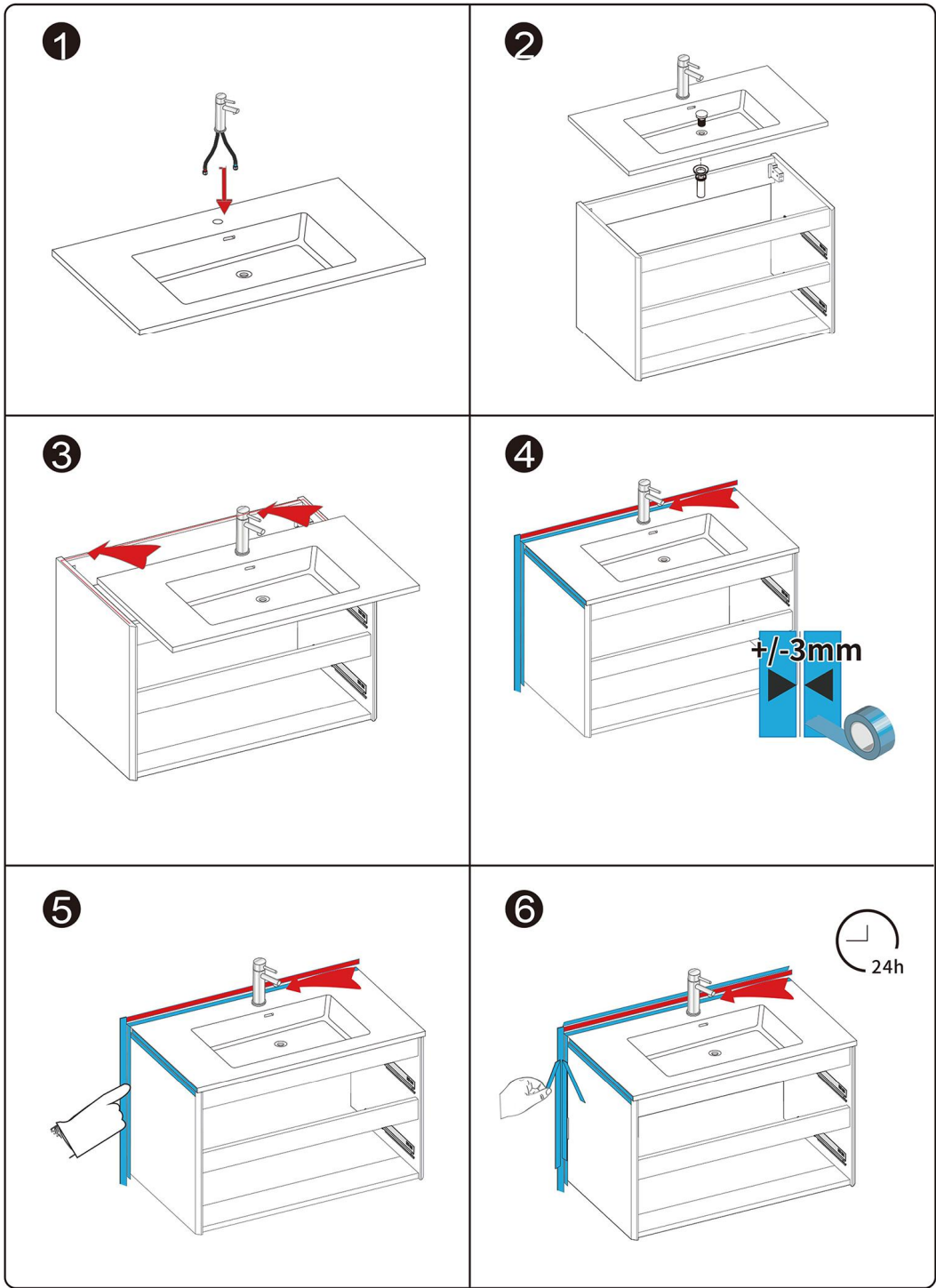



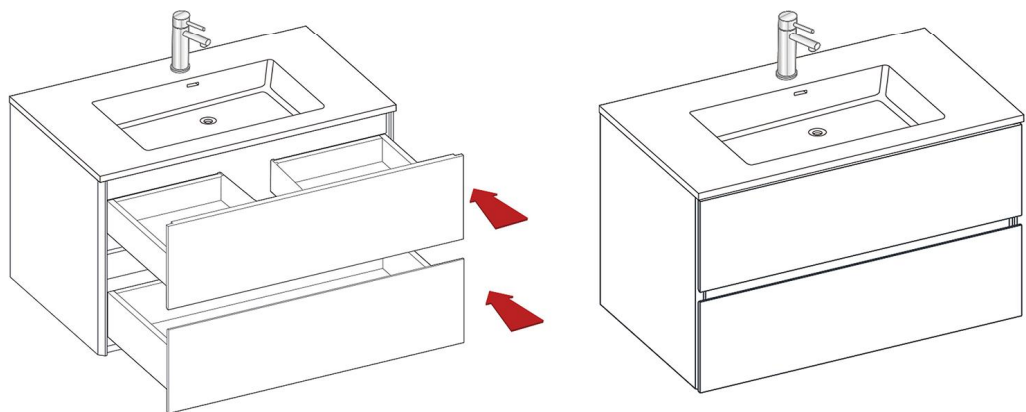















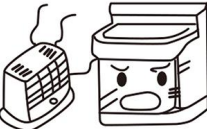

STEP 11



STEP 12



USER MAINTENANCE

<p>KEEP CABINET AWAY FROM WATER, which will cause deformation and damage.</p> <p>  </p> <p>CAUTION</p>	<p>DO NOT put lit cigarettes on the counter or basin, which will cause discoloration.</p> <p>  </p> <p>CAUTION</p>
<p>DO NOT pour acid or alkaline solutions into the basin, which will cause discoloration, leak or damage.</p> <p>  </p> <p>CAUTION</p>	<p>AVOID DIRECT SUNLIGHT, which may cause deformation and discoloration.</p> <p>  </p> <p>CAUTION</p>
<p>AVOID HEAT, which will cause deformation and discoloration.</p> <p>  </p> <p>CAUTION</p>	<p>DO NOT pour hot water into the basin, which may cause damage.</p> <p>  </p> <p>CAUTION</p>
<p>AVOID nylon brush, toilet cleaner or hydrochloric acid cleaner, which will cause damage</p> <p>  </p> <p>CAUTION</p>	<p>AVOID dropping hard objects into the basin, which may cause damage.</p> <p>  </p> <p>CAUTION</p>

To extend the life of the product, please do the maintenance work every day. The following maintenance methods are for reference only.

- Please dry the cabinet immediately with clean, soft cloth when it encounters water.
- When the product is stained with dirt, wipe the cabinets clean with a soft, damp cloth, apply some cleaners, and dry immediately with another clean, soft cloth.
- The water supply pipes, the drainage pipes, and the connection parts are prone to water leakage under different circumstances. Please check these parts regularly to avoid accidents due to water leakage.
- After the product is used for a period of time, dirt will remain on the drain plug, which will affect drainage, so the plug needs to be cleaned regularly.