

ASSEMBLY INSTRUCTIONS

72" x 36" x 31" - DINING TABLE WITH TURNING LEG

BEFORE BEGINNING:

- 1 - Carefully unpack and position the items on a clean, non-marring surface to assemble.
- 2 - Read this Assembly Instructions from beginning to end before starting to assemble.
- 3 - Take inventory of the required parts to ensure all are available.
- 4 - To prevent accidental choking hazards, keep all packaging materials away from small children.
- 5 - Only tighten hardware until ALL hardware are fully engaged on their locations. Overtighten bolts will damage the bolt threads.
- 6 - Use only factory provided hardware to assemble. Unapproved hardware can damage product or jeopardize the structural integrity of the product.
- 7 - The use of power tools to assemble is not recommended due to high risk of over-torque, which can damage product.

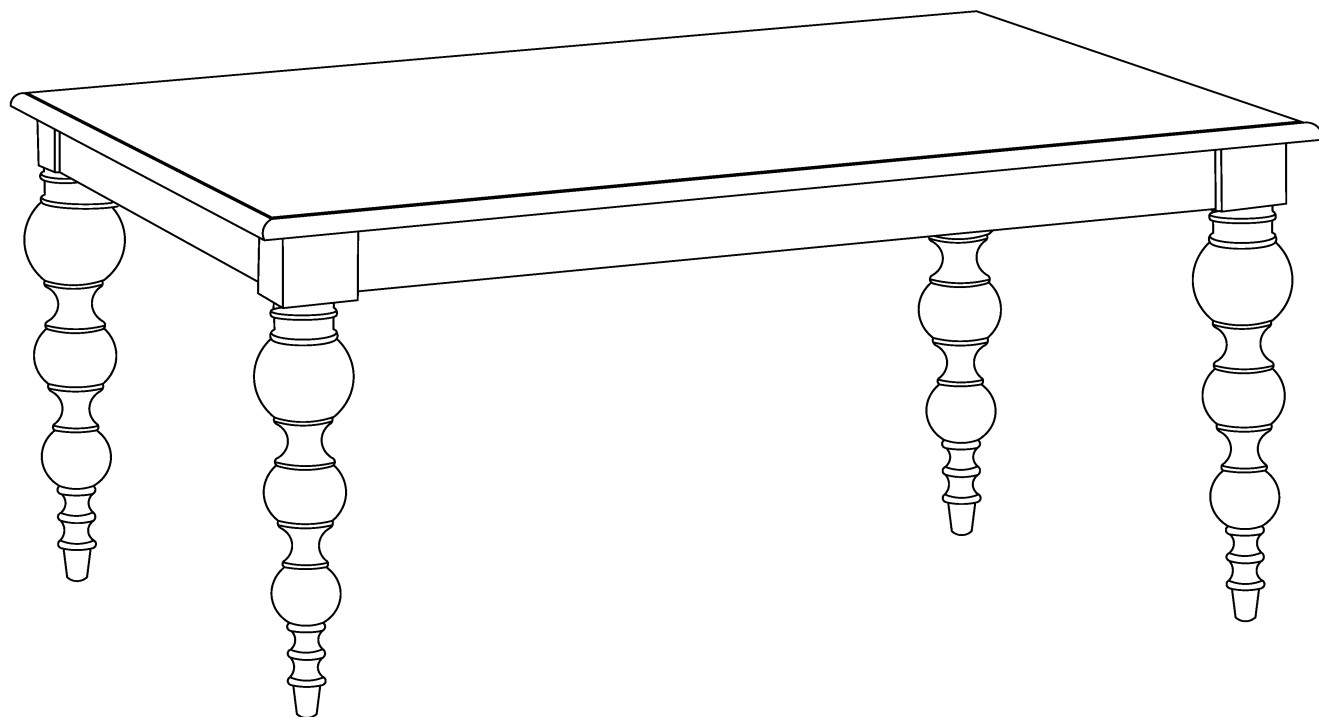

Assembly Requires
Two People.



20 - Minute
Assembly Time



Keep Instructions
For Future Use



Do Not Use
Power Tools

ASSEMBLY INSTRUCTIONS

72" x 36" x 31" - DINING TABLE WITH TURNING LEG

PARTS LIST

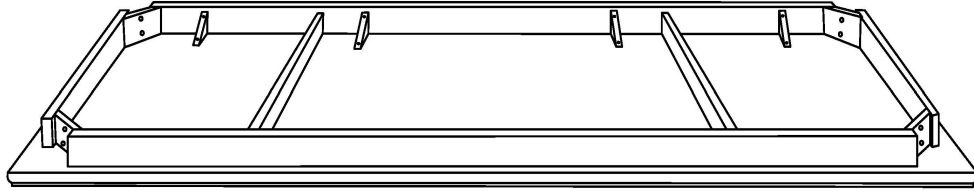

P1- x1

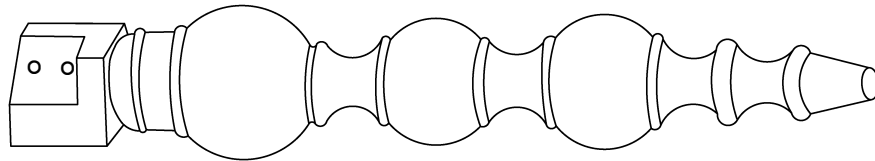

P2 - x4

HARDWARE PACK



H1- x 8

50x8mm



H2- x 8

16x8mm



H3- x 8

25x8mm



H4- x 1

5mm

ASSEMBLY INSTRUCTIONS

72" x 36" x 31" - DINING TABLE WITH TURNING LEG

STEP 1

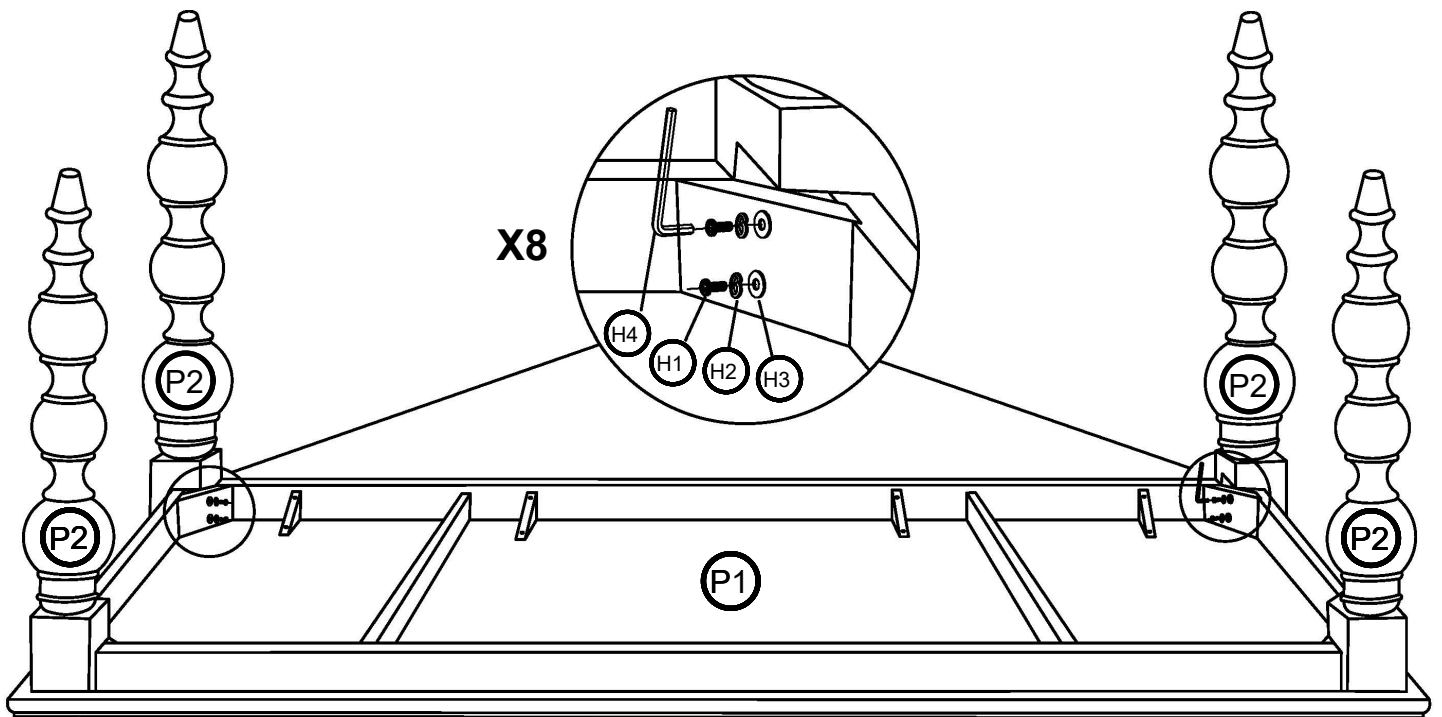

ASSEMBLY INSTRUCTIONS

72" x 36" x 31" - DINING TABLE WITH TURNING LEG

STEP 2

