

INSTRUCTIONS

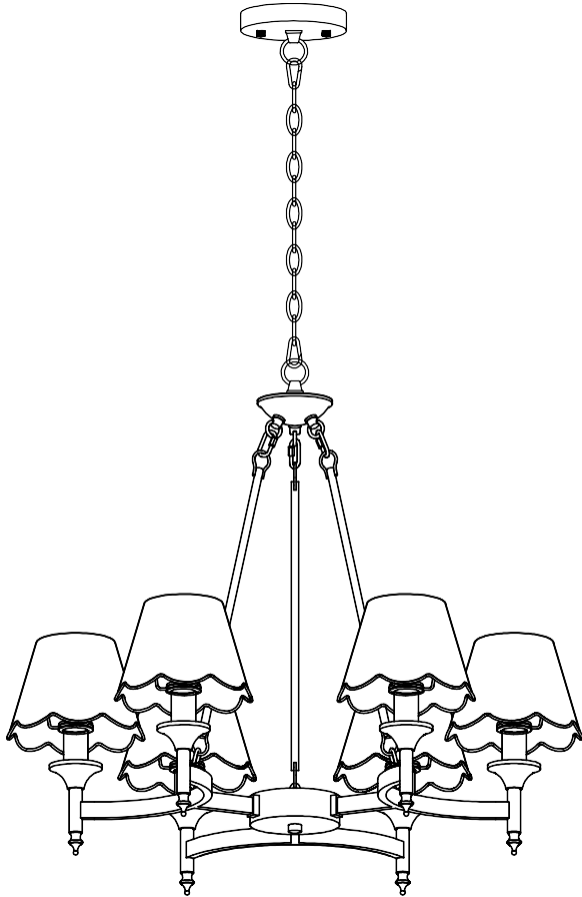



SAFETY INSTRUCTION

Please read and understand this entire manual before attempting to assemble, operate or install the product.

CAUTION: Read instructions carefully and turn electricity off at main circuit breaker panel before beginning installation.

CAUTION: Risk of fire. Min. 90°C supply conductors. Consult a qualified electrician to ensure correct branch circuit conductor.

WARNING: If any Special Control Devices are used with this fixture, follow instructions carefully to assure full compliance with N.E.C. requirements. If there are any questions, contact a qualified electrical contractor.

CAUTION: All glass is fragile. Use care when handling glass shades and bulbs.

PREPARATION

1. Before beginning installation, make sure all parts are included using the contents diagrams from page 3. If any part is missing or damaged, do not attempt to assemble, install or operate the product.

2. Tools required for assembly (not included): Phillips screwdriver, spanner, wire stripper, safety glasses, electrical tape, ladder, etc.

CARE and MAINTENANCE

Shut off main power supply before cleaning product or changing light bulbs. To clean, wipe with damp cloth. Do not use abrasive cleaners or cleaners that contain alcohol.

PACKAGE CONTENTS

| PART | DESCRIPTION | QUANTITY |
|------|----------------------|----------|
| A | Mounting Screws | 2 |
| B | Mounting Bracket | 1 |
| C | Ceiling Canopy | 1 |
| D | Decorative Fasteners | 2 |
| E | Chain suspension | 1 |
| F | Chain Ring | 1 |
| G | Round plate | 1 |
| H | Supporter Canopy | 1 |
| I | Pull Rod | 3 |
| J | Cover | 1 |
| K | Nut | 1 |
| L | Clip | 2 |
| M | Shade | 6 |
| N | Arm | 3 |
| O | Fastener | 6 |

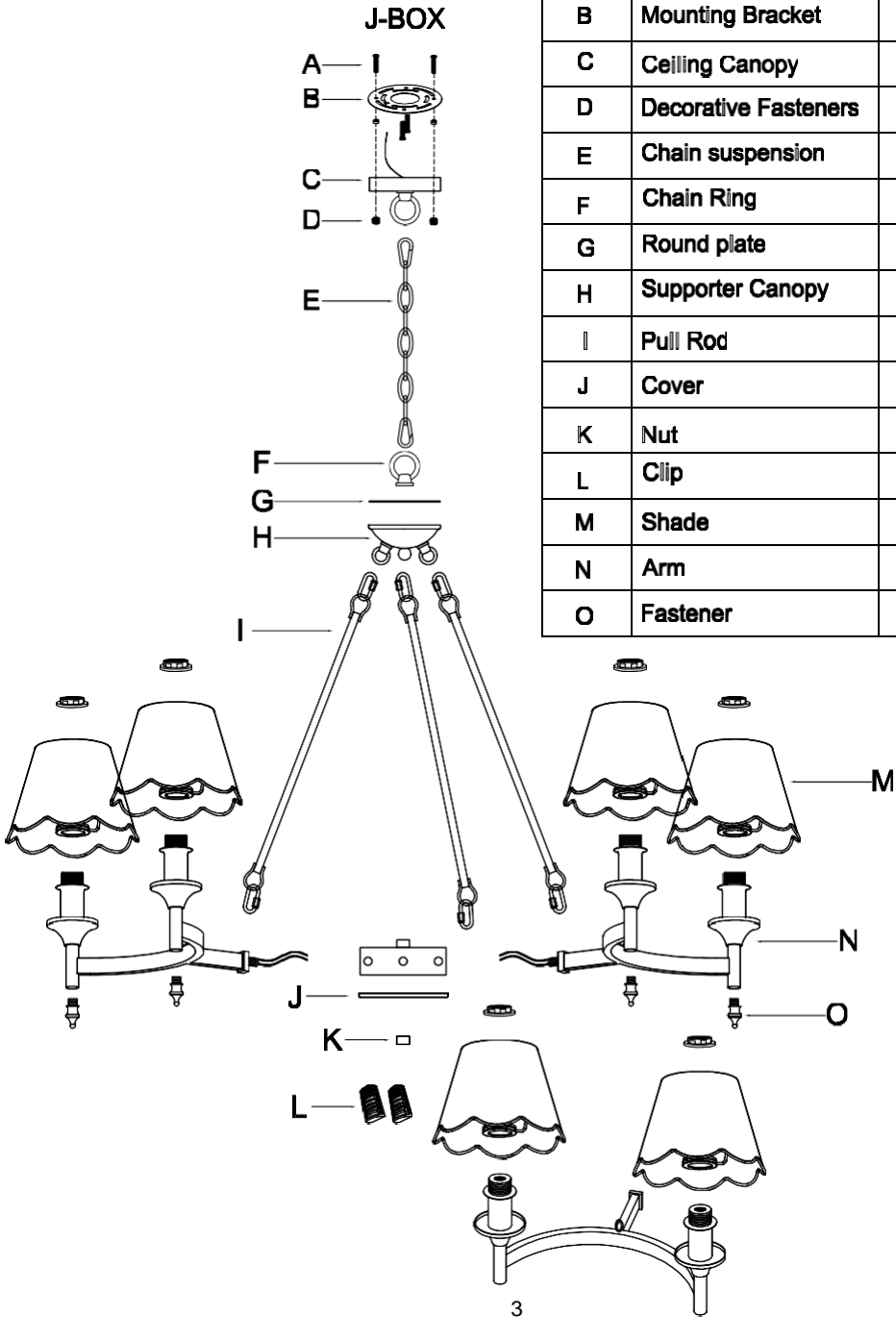

LAMPBODY ASSEMBLY INSTRUCTIONS

1

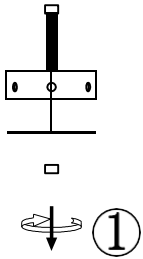

2

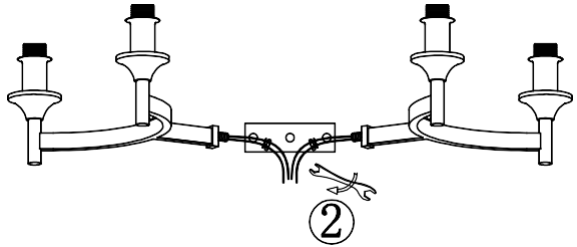

3

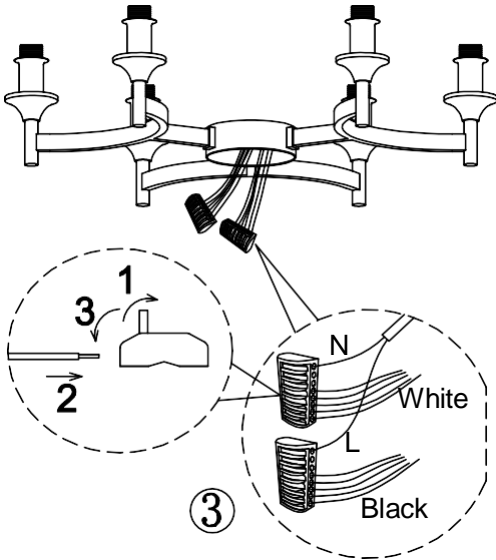

4

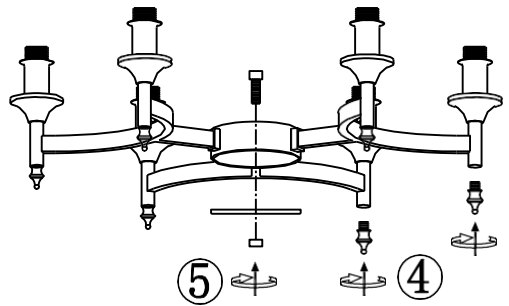

5

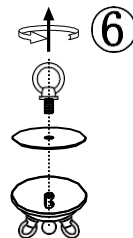

Gold Chandelier Wiring Instructions:
L(live wire) to connect the black wire
N(neutral wire) to connect the white wire

LAMPBODY WIRING INSTRUCTIONS

6

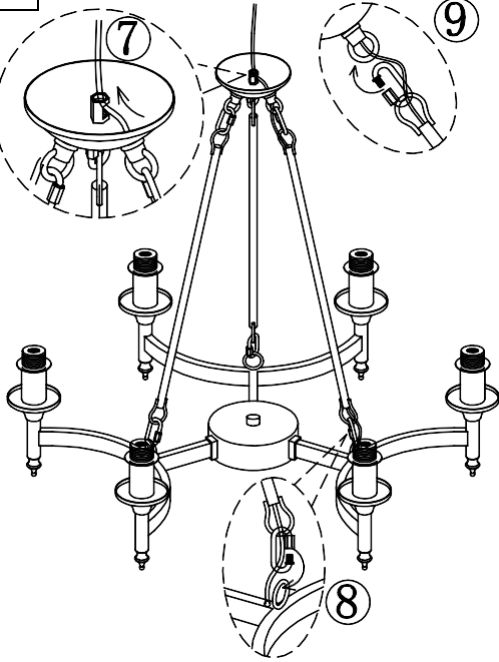

7

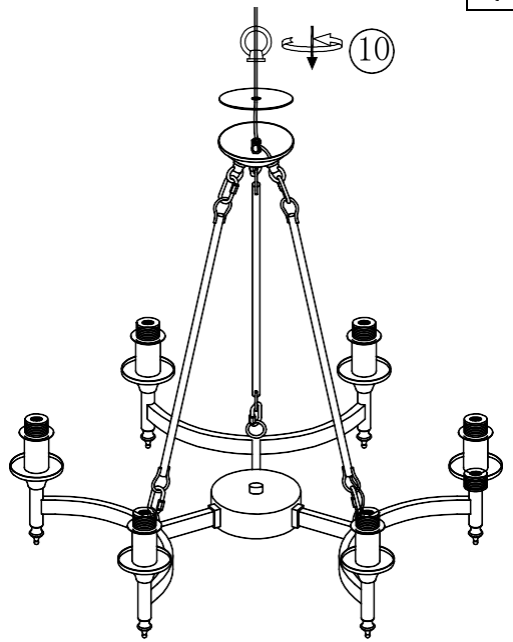

8

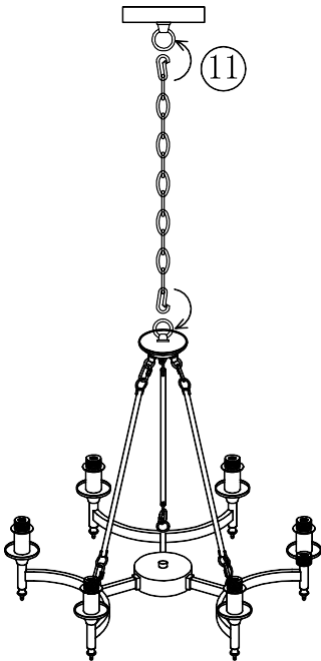

5

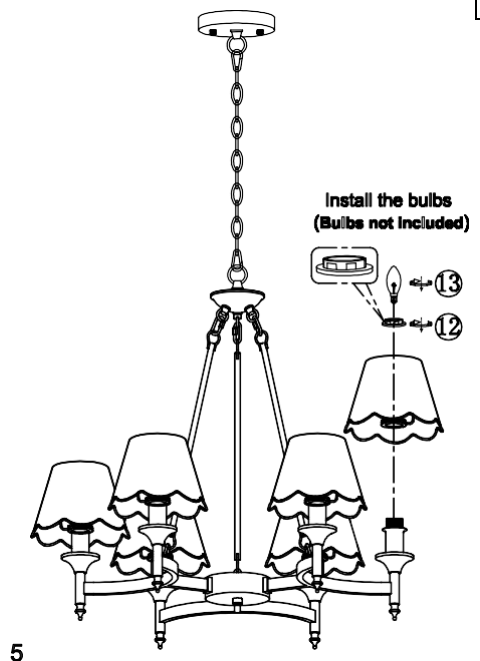

5

CANOPY INSTALLATION INSTRUCTIONS

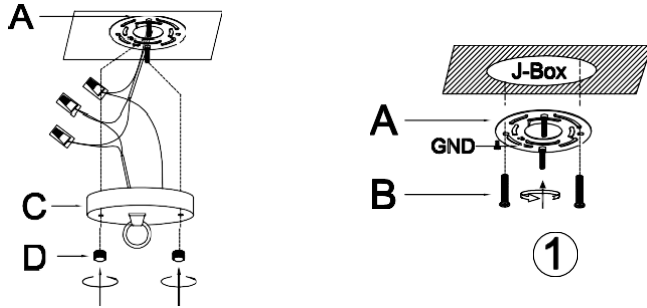

After Wire connection, tuck all the wires carefully into the Junction-Box. Position Canopy(C) over Mounting Bracket(A), allowing two screws to protrude through openings of canopy, then lock with two decorative fasteners(D).

HOUSE WIRES

FIXTURE WIRES

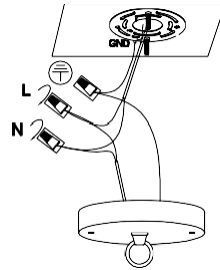
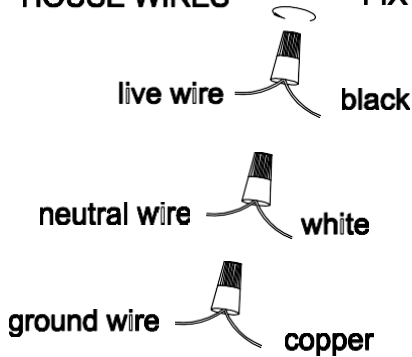

1. Secure Mounting Bracket (A) to ceiling junction box by two mounting screws (B).
2. Connect carefully! using the wire cap (provided) to connect the black fixture wire and the black supply wire, and to connect the white fixture wire and the white supply wire. Wrap the connection with electrical tape.
3. Connect ground wire from canopy with ground wire from junction box using a wire cap. Wrap with electrical tape for a more secure connection. If house does not have ground wire, attach grounding wire to green grounding screw marked GND.
4. Tuck all wires carefully into the J-Box.



WARNING: Never connect grounding wire to black or white power supply wires. It is imperative that the outlet box in your home be properly grounded.

WARRANTY SERVICES

2-Year warranty services are provided for this product, if you have any problems during the warranty period, please feel free to contact via email mail, your order ID and detail are preferred so that customer support will help faster.

Note: please use this product accordingly to its intended purpose, do not retrofit or remodeling the product. The warranty does not cover if the failure is caused by the third party product, or natural disasters.