

ASSEMBLY INSTRUCTION
(INSTRUCTIONS DE MONTAGE)
ITEM NO.N717P419128

Dining Table
(Table à manger)

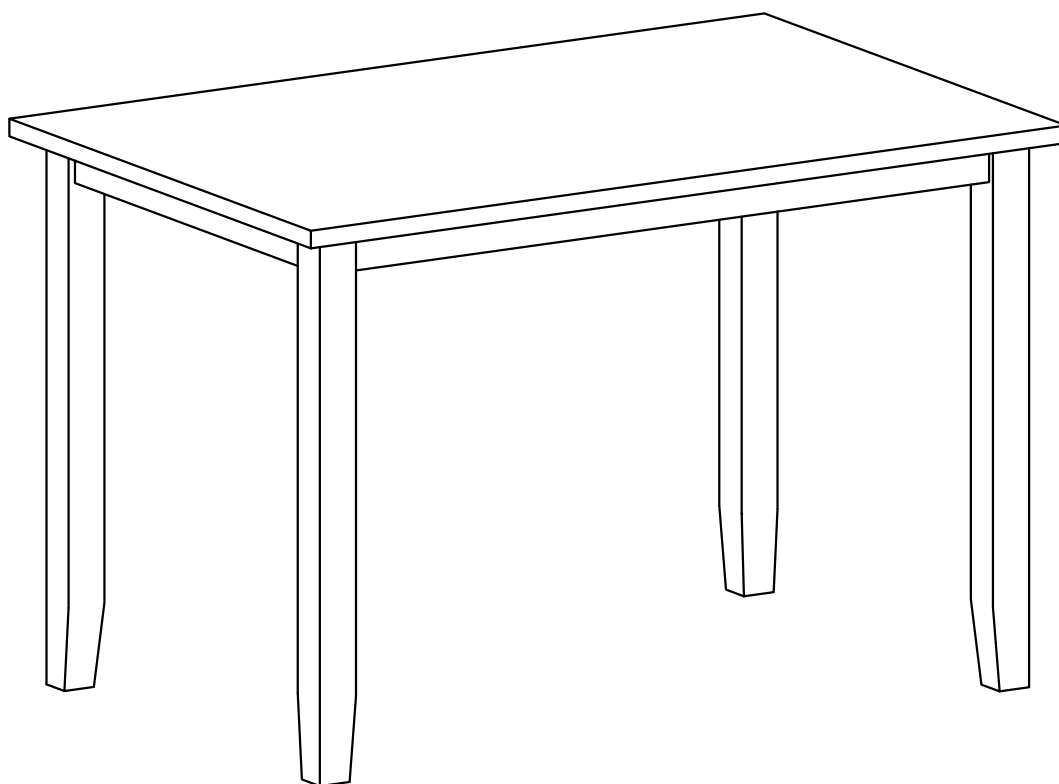

ASSEMBLY INSTRUCTION

(INSTRUCTIONS DE MONTAGE)

ITEM NO.N717P419128

Please read these instructions fully before starting assembly:

(Veuillez lire attentivement ces instructions avant de commencer l'assemblage :)

1. Place all wooden parts on a clean and smooth surface such as a rug or carpet to avoid scratching the parts.
(Placez toutes les pièces en bois sur une surface propre et lisse, comme un tapis ou une moquette, pour éviter de les rayer.)
2. Kindly follow the assembly instructions step by step.
(Veuillez suivre les instructions de montage étape par étape.)
3. Do not tighten all screws and bolts until the table is fully assembled.
(Ne serrez pas toutes les vis et tous les boulons tant que la table n'est pas entièrement assemblée.)
4. Unscrew the protective plastic supports from the metal insert of the table legs before assembly.
(Dévissez les supports de protection en plastique de l'insert métallique des pieds de la table avant le montage.)
5. Parts of the assembly will be easier with 2 people.
(Certaines parties du montage seront plus faciles à réaliser à 2 personnes.)

Care and maintenance:

(Entretien et maintenance :)

Only clean using a damp cloth and mild detergent, do not use bleach or abrasive cleaners.

(Nettoyer uniquement avec un chiffon humide et un détergent doux, ne pas utiliser d'eau de Javel ni de nettoyants abrasifs.)

ASSEMBLY INSTRUCTION

(INSTRUCTIONS DE MONTAGE)

ITEM NO.N717P419128

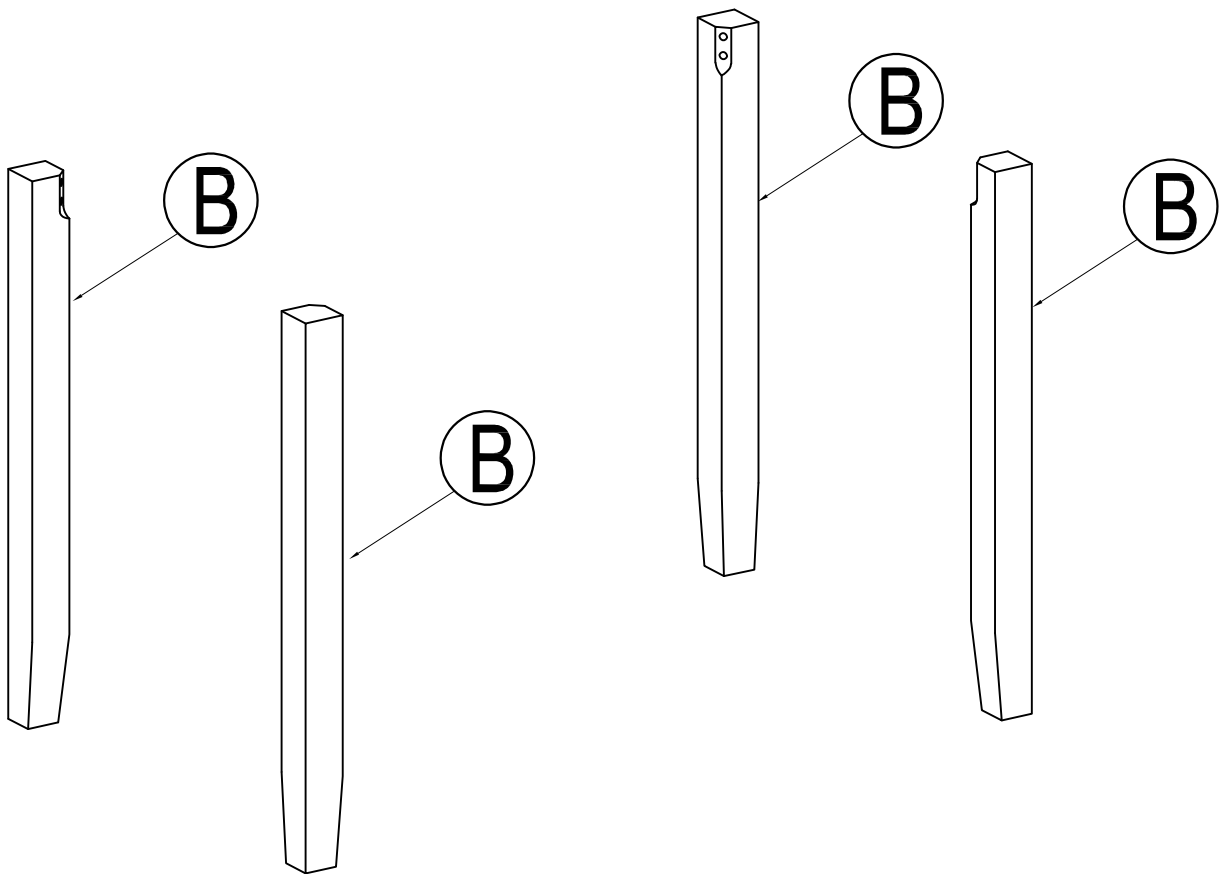
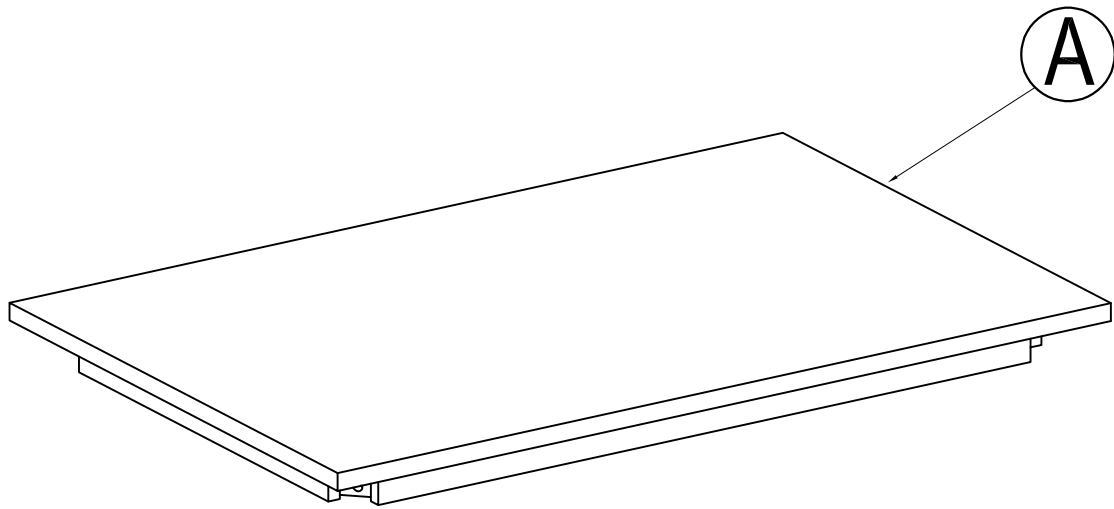

ASSEMBLY INSTRUCTION

(INSTRUCTIONS DE MONTAGE)

ITEM NO.N717P419128

Part List (Liste des pièces)

Ⓐ

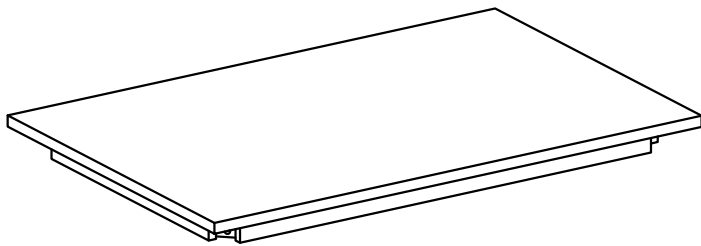
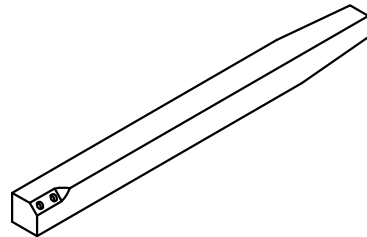

TABLE TOP (1pc)
(PLATEAU DE TABLE)

Ⓑ







LEG (4 pcs)
(JAMBE)

ASSEMBLY INSTRUCTION

(INSTRUCTIONS DE MONTAGE)

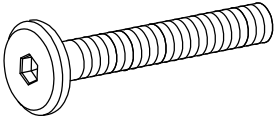
ITEM NO.N717P419128

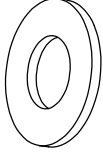
Hardware List (Liste du matériel)





<p>①</p>  <p>Ø 5/16" x 70 mm</p>	<p>②</p>  <p>Ø5/16" x 13 mm</p>
<p>BOLT (8 pcs) (BOULON)</p>	<p>LOCK WASHER (8 pcs) (RONDELLE DE FREIN)</p>
<p>③</p>  <p>Ø5/16" x 19 x 2 mm</p>	<p>④</p>  <p>4 mm</p>
<p>FLAT WASHER (8 pcs) (RONDELLE PLATE)</p>	<p>ALLEN KEY (1 pc) (CLÉ ALLEN)</p>

ASSEMBLY INSTRUCTION (INSTRUCTIONS DE MONTAGE)

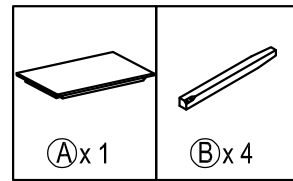
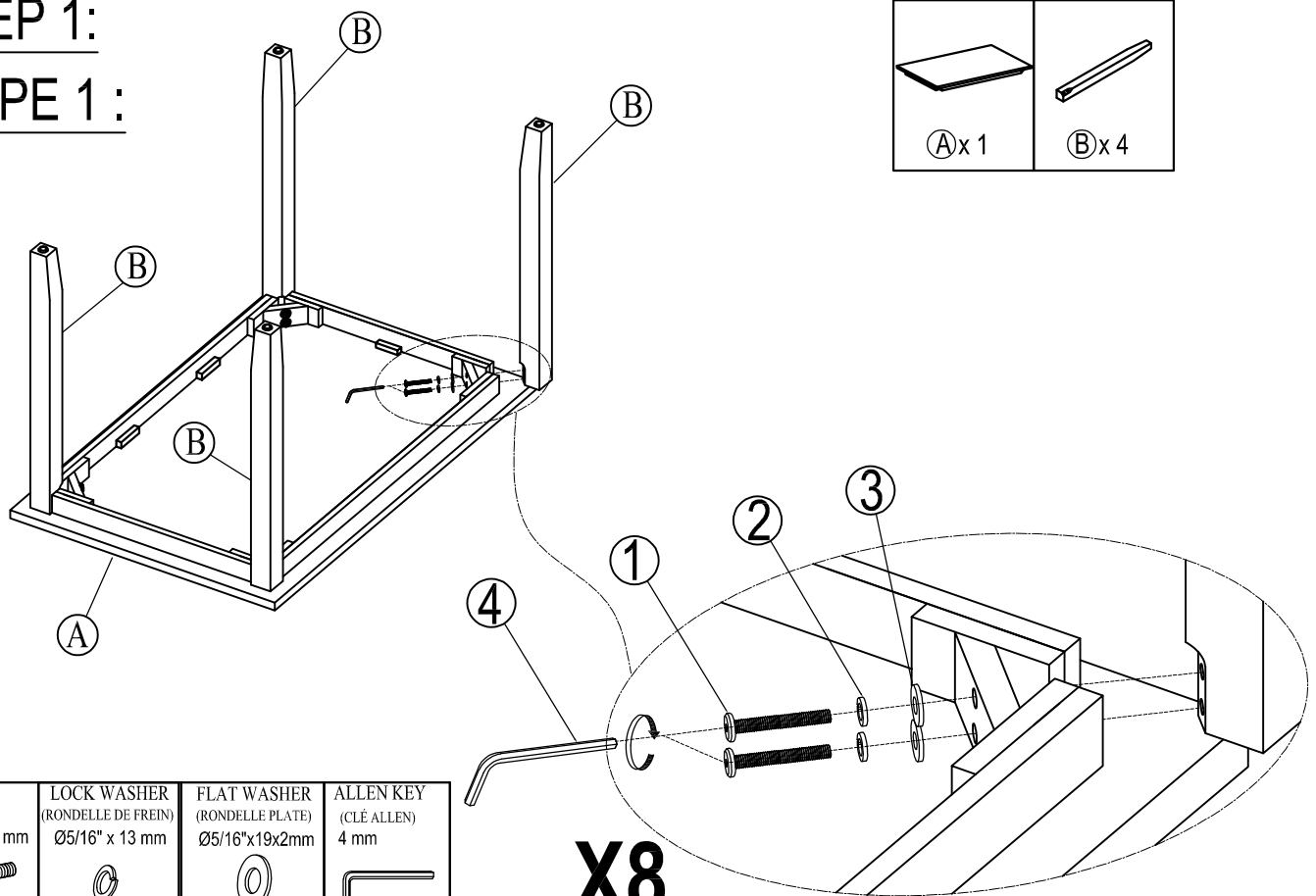
ITEM NO.N717P419128

STEP 1:
ÉTAPE 1 :



BOLT (BOULON) Ø 5/16" x 70 mm  ① x 8	LOCK WASHER (RONDELLE DE FREIN) Ø 5/16" x 13 mm  ② x 8	FLAT WASHER (RONDELLE PLATE) Ø 5/16" x 19 x 2 mm  ③ x 8	ALLEN KEY (CLÉ ALLEN) 4 mm  ④ x 1
---	--	---	---

X8

COMPLETE
(COMPLÈTE)

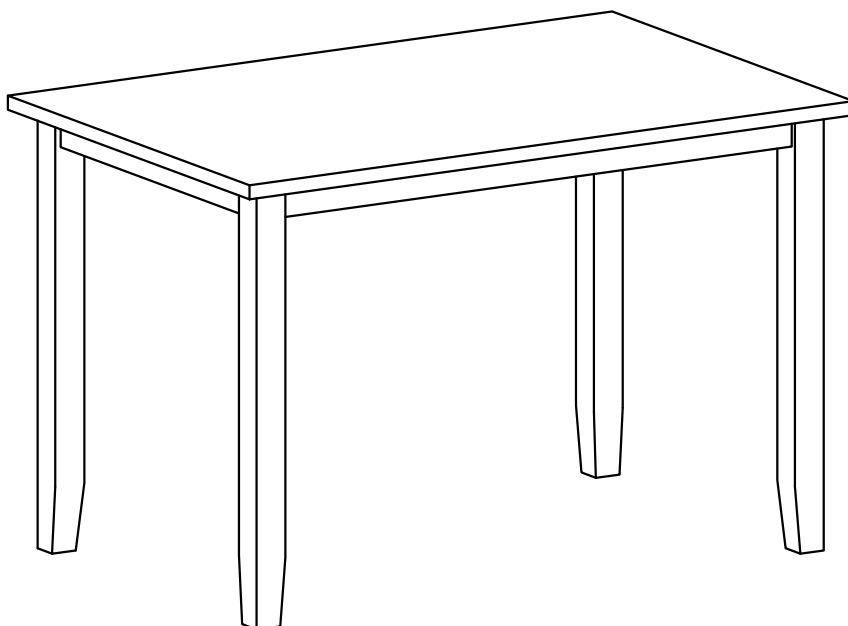

ASSEMBLY INSTRUCTION (INSTRUCTIONS DE MONTAGE)

ITEM NO.N717P419129

Dining Chair
(Chaise à manger)

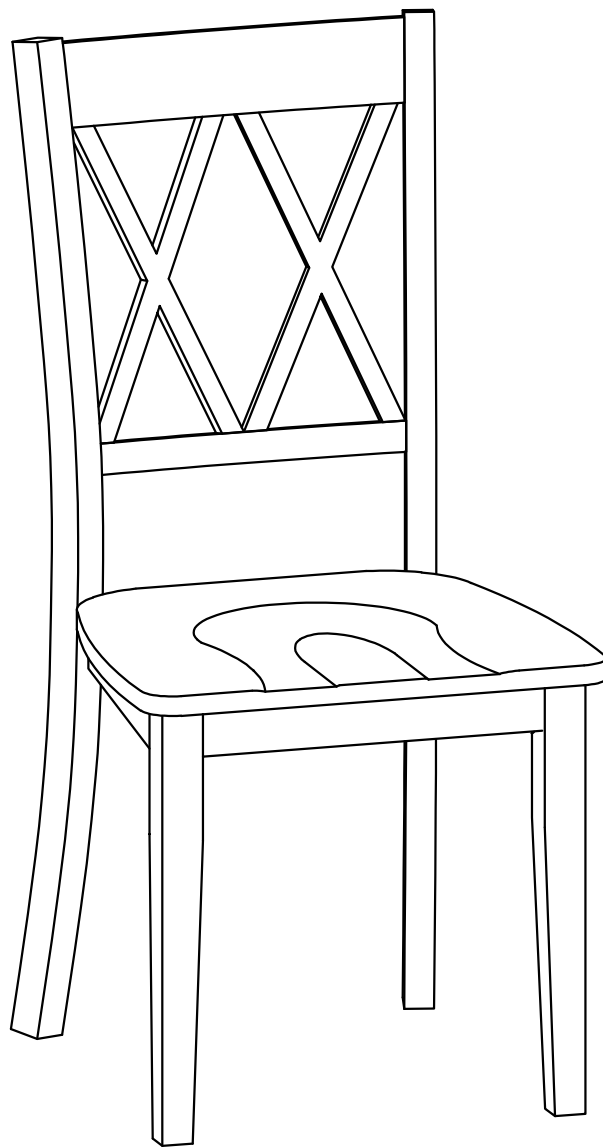

ASSEMBLY INSTRUCTION

(INSTRUCTIONS DE MONTAGE)

ITEM NO.N717P419129

Please read these instructions fully before starting assembly:

(Veuillez lire attentivement ces instructions avant de commencer l'assemblage :)

1. Place all wooden parts on a clean and smooth surface such as a rug or carpet to avoid scratching the parts.
(Placez toutes les pièces en bois sur une surface propre et lisse, comme un tapis ou une moquette, pour éviter de les rayer.)
2. Kindly follow the assembly instructions step by step.
(Veuillez suivre les instructions de montage étape par étape.)
3. Do not tighten all screws and bolts until the table is fully assembled.
(Ne serrez pas toutes les vis et tous les boulons tant que la table n'est pas entièrement assemblée.)
4. Unscrew the protective plastic supports from the metal insert of the table legs before assembly.
(Dévissez les supports de protection en plastique de l'insert métallique des pieds de la table avant le montage.)
5. Parts of the assembly will be easier with 2 people.
(Certaines parties du montage seront plus faciles à réaliser à 2 personnes.)

Care and maintenance:

(Entretien et maintenance :)

Only clean using a damp cloth and mild detergent, do not use bleach or abrasive cleaners.

(Nettoyer uniquement avec un chiffon humide et un détergent doux, ne pas utiliser d'eau de Javel ni de nettoyants abrasifs.)

ASSEMBLY INSTRUCTION (INSTRUCTIONS DE MONTAGE)

ITEM NO.N717P419129

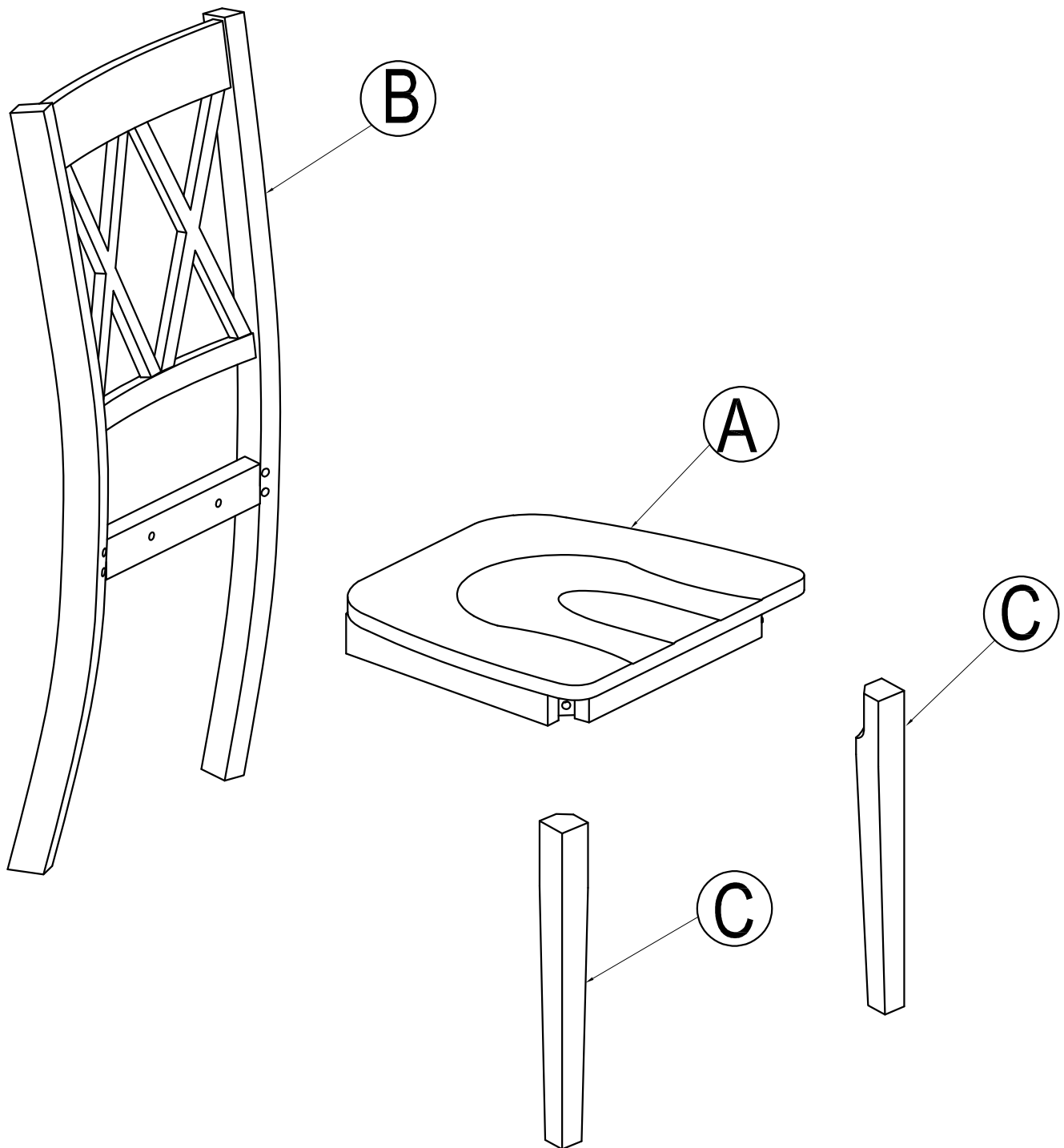

ASSEMBLY INSTRUCTION (INSTRUCTIONS DE MONTAGE)

ITEM NO.N717P419129

Part List (Liste des pièces)

(A)

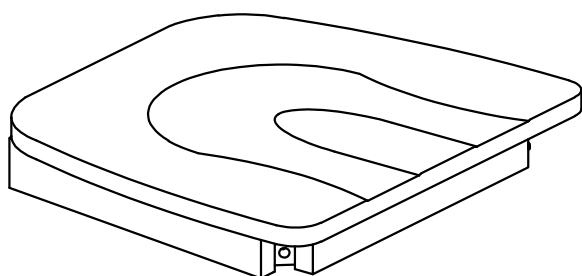

SEAT FRAME (4 pcs)
(CADRE DE SIÈGE)

(B)

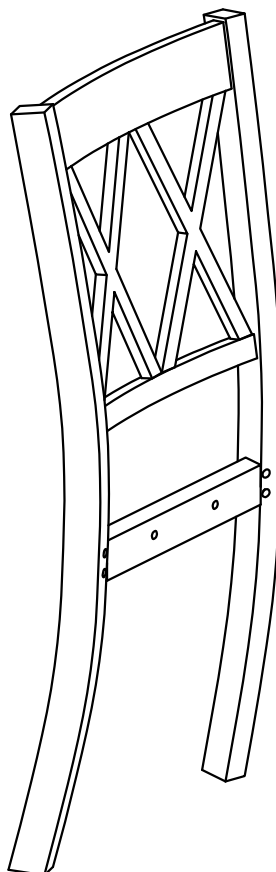

BACK FRAME (4 pcs)
(CADRE ARRIÈRE)

(C)

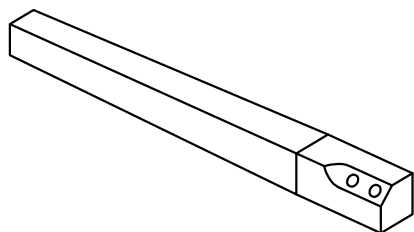

LEG (8 pcs)
(JAMBE)

ASSEMBLY INSTRUCTION (INSTRUCTIONS DE MONTAGE)

ITEM NO.N717P419129

Hardware List (Liste du matériel)

①

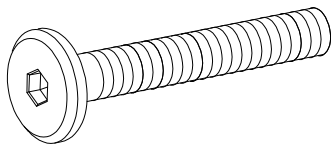

Ø 1/4" x 40 mm

BOLT (8 pcs)
(BOULON)

②

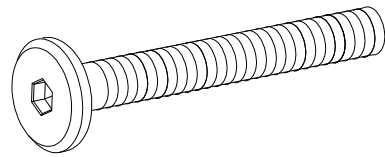

Ø 1/4" x 55 mm

BOLT (16 pcs)
(BOULON)

③

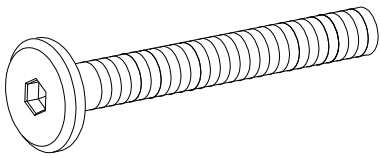

Ø 1/4" x 75 mm

BOLT (16 pcs)
(BOULON)

④



Ø5/16" x 13 mm

LOCK WASHER (40 pcs)
(RONDELLE DE FREIN)

⑤

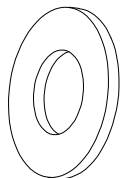

Ø5/16" x 19 x 2 mm

FLAT WASHER (40 pcs)
(RONDELLE PLATE)

⑥



4 mm

ALLEN KEY (1 pc)
(CLÉ ALLEN)





ASSEMBLY INSTRUCTION (INSTRUCTIONS DE MONTAGE)

ITEM NO.N717P419129

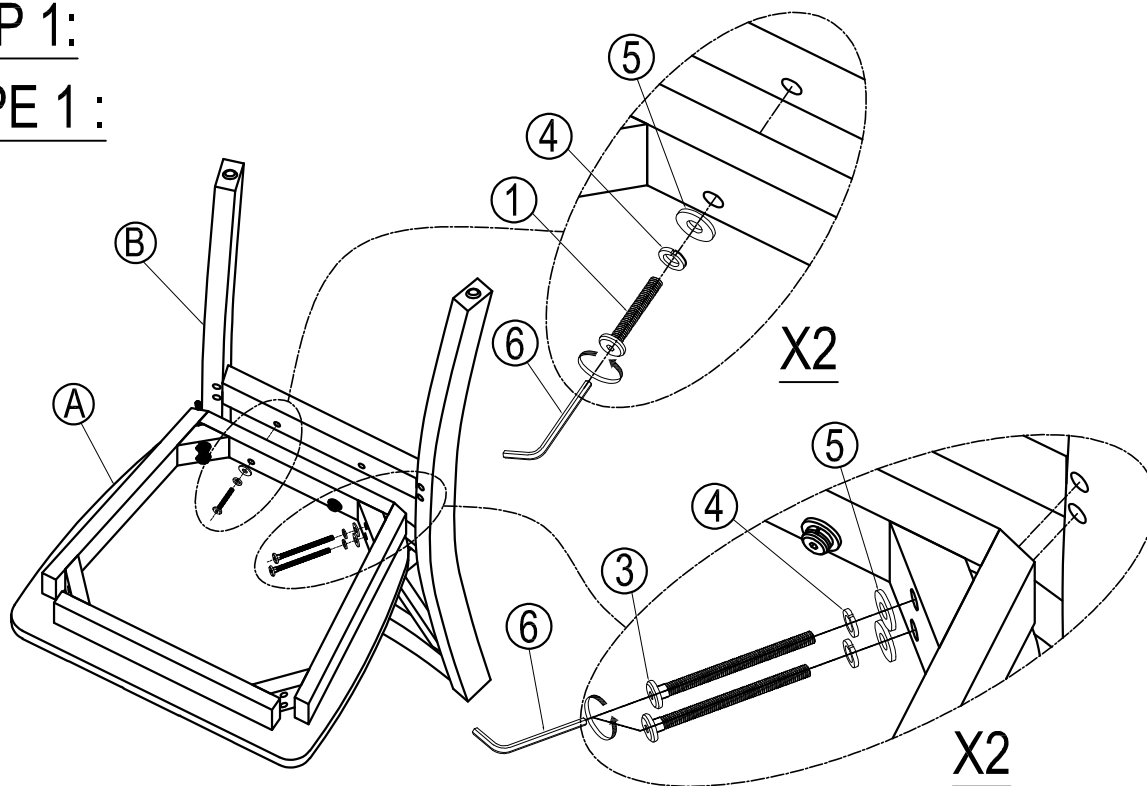
STEP 1:

ÉTAPE 1 :





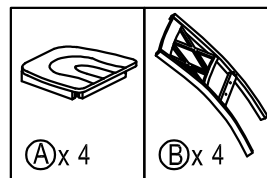

BOLT (BOULON) Ø 1/4" x 40 mm  ①x 8	BOLT (BOULON) Ø 1/4" x 75 mm  ③x 16	LOCK WASHER (RONDELLE DE FREIN) Ø5/16" x 13 mm  ④x 24	FLAT WASHER (RONDELLE PLATE) Ø5/16" x 19 x 2 mm  ⑤x 24	ALLEN KEY (CLÉ ALLEN) 4 mm  ⑥x 2
---	---	---	--	--

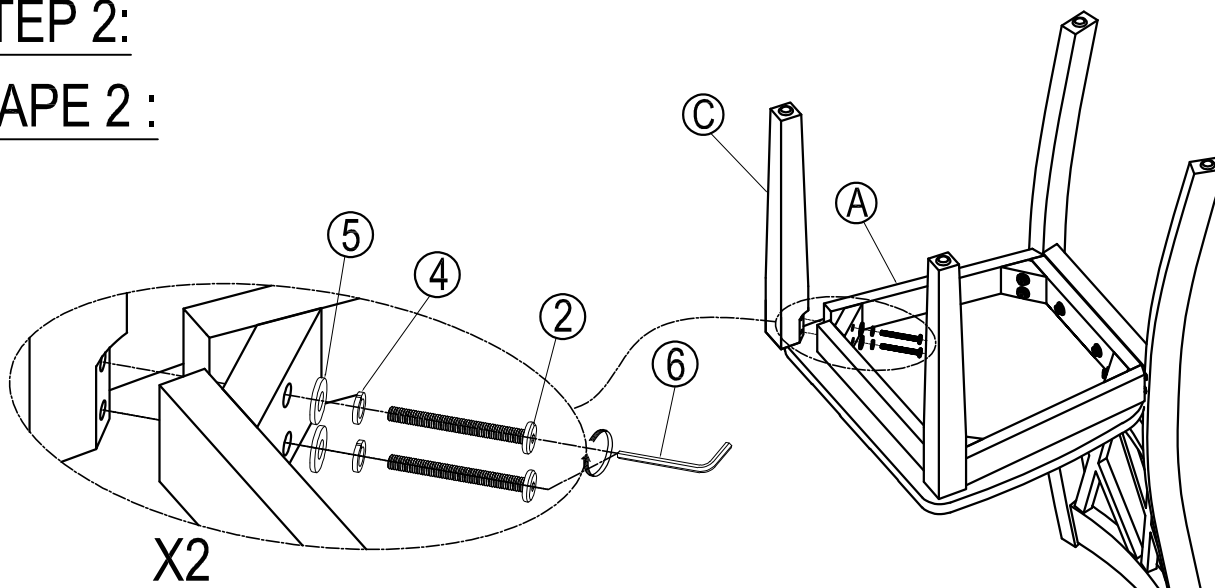

STEP 2:

ÉTAPE 2 :



BOLT (BOULON) Ø 1/4" x 55 mm  ②x 16	LOCK WASHER (RONDELLE DE FREIN) Ø5/16" x 13 mm  ④x 16	FLAT WASHER (RONDELLE PLATE) Ø5/16" x 19 x 2mm  ⑤x 16	ALLEN KEY (CLÉ ALLEN) 4 mm  ⑥x 1
--	---	---	--

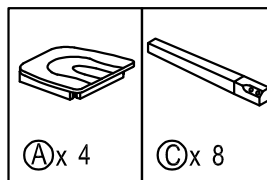

ASSEMBLY INSTRUCTION (INSTRUCTIONS DE MONTAGE)

ITEM NO.N717P419129

COMPLETE
(COMPLÈTE)

