

User Manual

See it - Feel it - Live it

Parts List

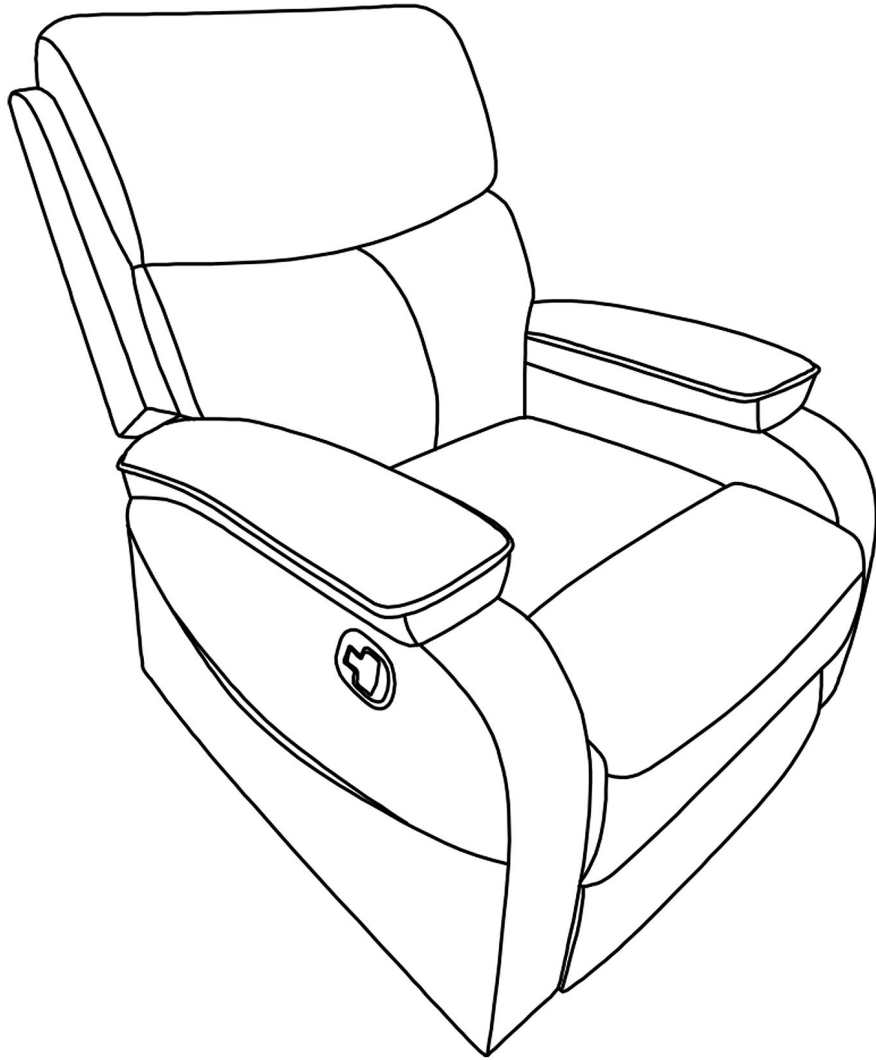

A

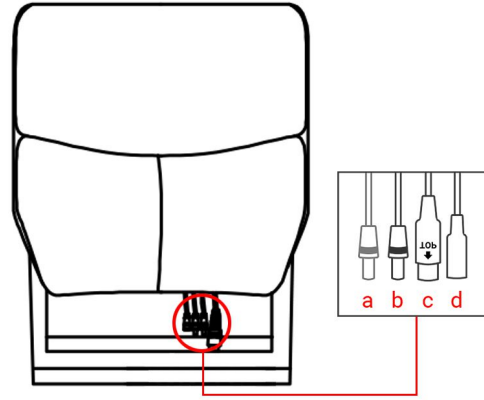

Backrest

B

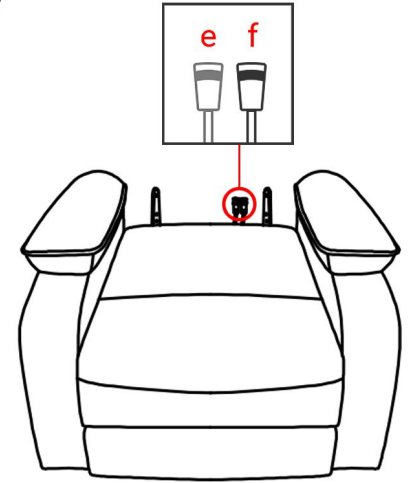

Seat Cushion

C



Massage Remote Control

D

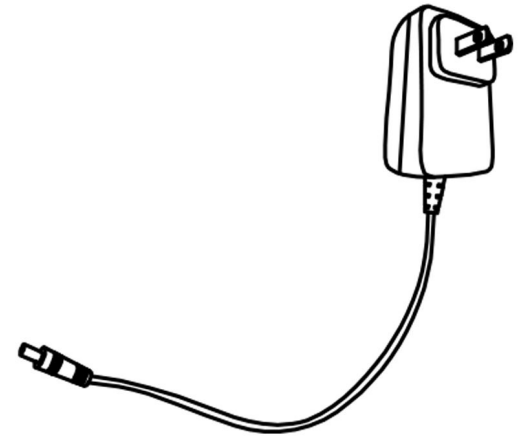

Power Adapter

Assembly Instructions

STEP 1

Secure the backrest to the buckles behind the seat cushion

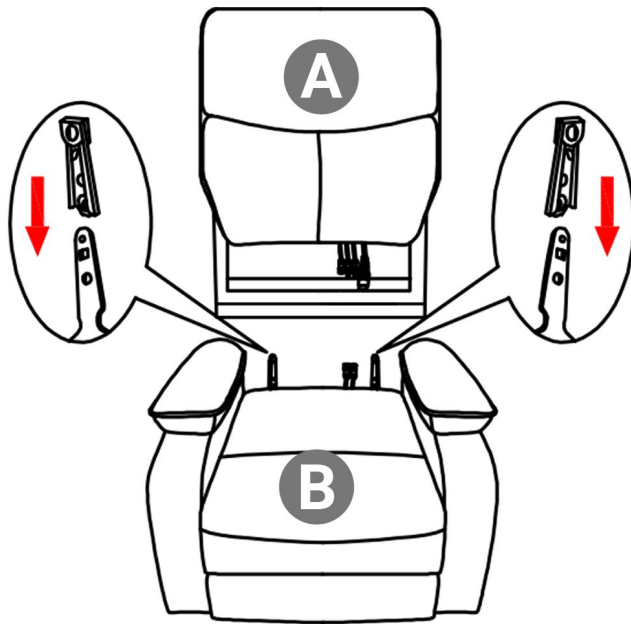

STEP 2

Connect wires as per the diagram

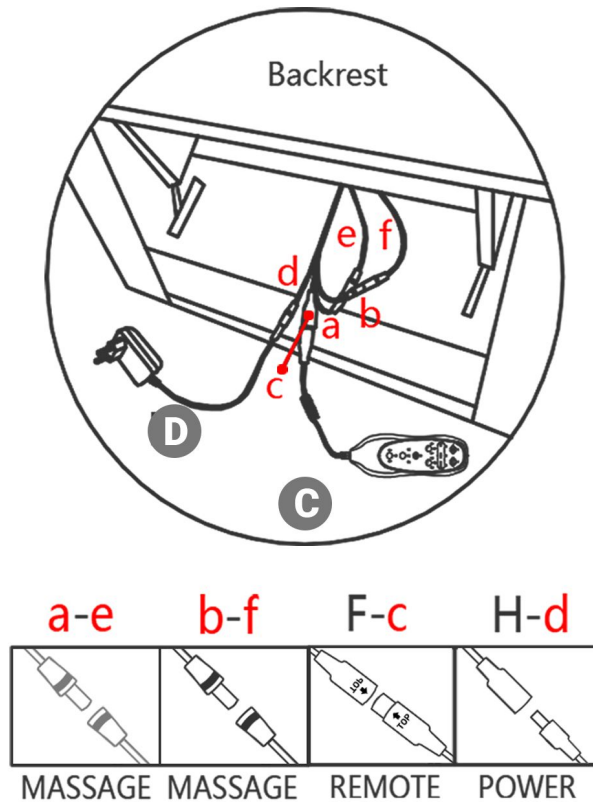

STEP 3

Installation Completed

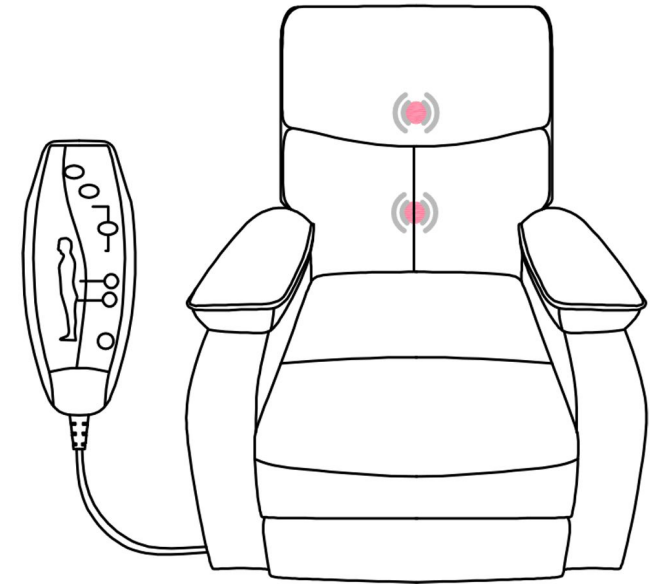

Warning: In the interest of health and safety, Please ensure no obstacles, children or pets are near the chair mechanism or the area Underneath when the chair is in use. This is not a play area. Vigilance is required to avoid accidents.

OPERATION INSTRUCTIONS:

1. Connect the hand control cable female head of the hand controller to the hand control cable male head coming out of the sofa.
2. Connect the DC black male connector of the power adapter to the DC black female connector coming out of the sofa.
3. Press **POWER** button to turn on or off vibration massage.
4. Press **INTRNSITY** button switches the intensity of vibration massage, and there are two kinds of intensity can be switched.
5. Press **MODE** button switches between massage modes, which can be switched in five modes.
6. Press **BACK** button, turn on or off the back vibration massage.
7. Press **LUMBAR** button, turn on or off the lumbar vibration massage.
8. Press **TIMER** button to switch vibration massage function timing, 15 minutes, 30 minutes or 60 minutes.

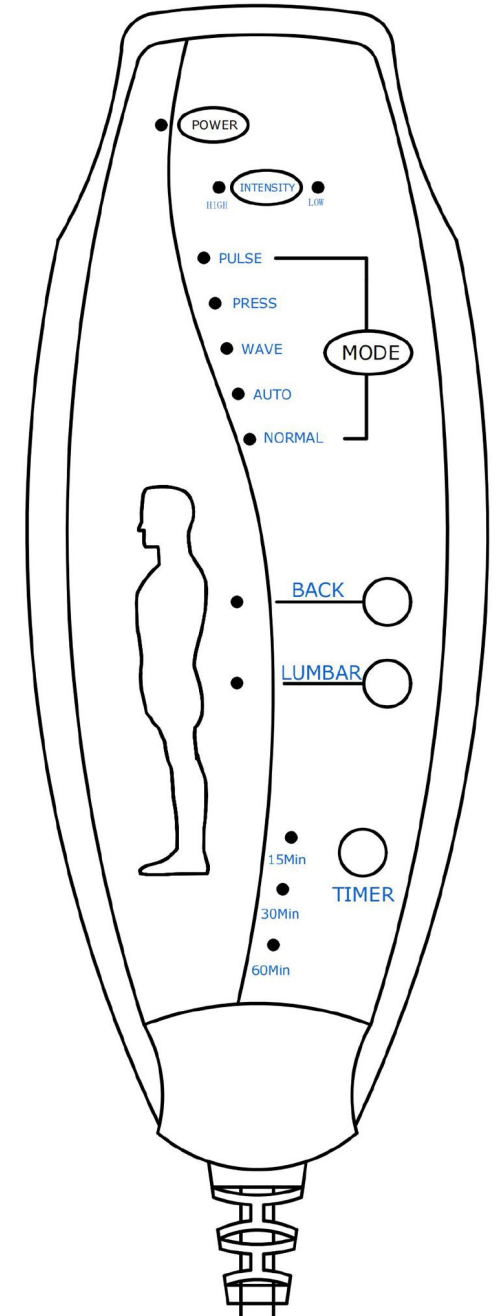

IMPORTANT SAFETY INSTRUCTIONS

When using an electrical appliance, basic precautions should always be followed, including the following:

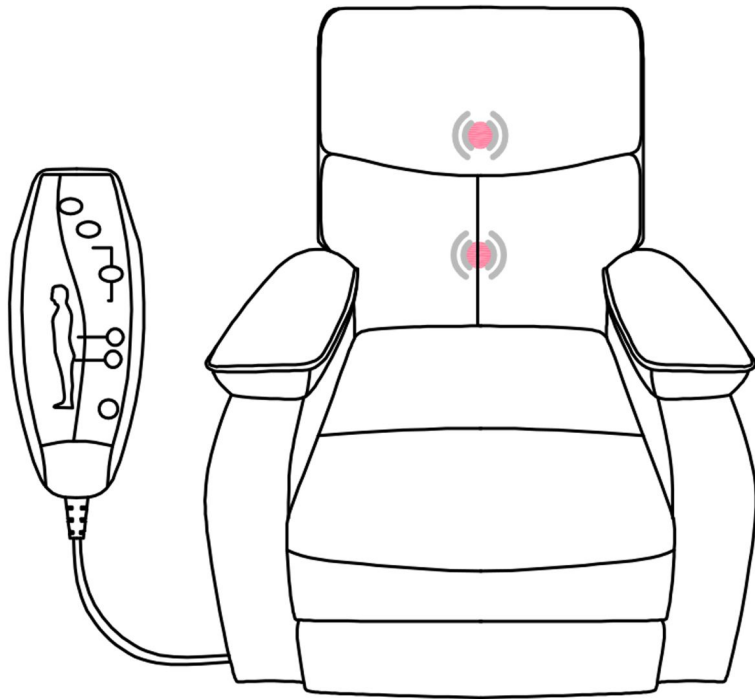

- 1.** This product is for use on a 12V circuit. Make sure that the product is connected to an outlet having the same configuration as the plug.
- 2.** Always unplug the massager from the power source after use, and before cleaning.
- 3.** Do not reach for massager if it has fallen into water. Unplug immediately.
- 4.** An appliance should never be left unattended when plugged in. Unplug from outlet when not in use, before putting on or taking off parts or attachments.
- 5.** Do not use outdoors.
- 6.** Do not carry this appliance by supplied cord as a handle.
- 7.** Keep the cord away from heated surfaces.
- 8.** Close supervision is necessary when this appliance is used by or near children, invalids or disabled persons.
- 9.** This unit is not a toy. Children should not use it or play with it.
- 10.** Do not operate where aerosol (spray) products are being used or where oxygen is being administered.
- 11.** Do not use near eyes or other highly sensitive areas.
- 12.** To disconnect, push "POWER" key to "OFF" place, make sure all functions stopped, then remove plug from outlet.
- 13.** Keep cord away from heated surfaces.
- 14.** Use this appliance only for its intended use as described in this manual. Do not use attachments not provided with the unit.

Health caution

- 1.If you have any concerns regarding your health, consult your doctor before using this product.
- 2.Individuals with pacemakers should not use this product.
- 3.If you experience pain in a muscle or joint for a prolonged period of time. Discontinue use and consult your doctor.Persistent pain could be a symptom of a more serious condition.

Maintenance instructions

TO STORE:

Place unit in its box or safe, dry, cool place. Avoid contact with sharp edges or pointed objects which might cut or puncture the fabric. Do not wrap power cord around the unit. Do not hang the unit by power cord.

TO CLEAN:

- 1.Insure the unit is unplugged from the power source, and allow to cool before cleaning.
- 2.Do not place in any liquid to clean. Clean fabric cover by wiping with a damp sponge, using a mild detergent or suds. Pat dry with clean, dry cloth.
- 3.Do not use abrasive cleaners, brushes, gasoline, kerosene, glass/furniture polish, paint thinner or water hotter than 120°C to clean the unit.
- 4.To clean the unit, make sure the massager is unplugged. Allow the unit to cool and the wipe down with a damp clean cloth. Do not use any strong chemical cleaners.

