

TD5000  
TD5001

# 3D Printer Cart



## Assembly Guide TD5000\_TD5001\_2015\_C

Check out our other products online at  
[www.copernicused.com](http://www.copernicused.com)

For assistance, please contact us:

**1-800-267-8494**

Email [info@copernicused.com](mailto:info@copernicused.com)

Have your packing slip ready for reference

## WARNING !

- This product is meant to be assembled by an adult.
- In its unassembled state, small parts present a hazard.
- To be used under direct supervision of an adult.



**TD5000**

- 1 Tiny Tub**
- 4 Open Tubs**
- 1 Really Big Tub**



**TD5001**

- 1 Tiny Tub**
- 2 Open Tubs**
- 1 Tech Tub**
- 1 Really Big Tub**

Printer and accessories not included with either unit.



**Please Recycle**



# Warning! Hazard Risks!

Please read the warnings below for important safety information regarding your product. Failure to read these warnings or to follow the instructions below could result in personal injury or damage to your product that could void your warranty.



Small Parts

In its unassembled state, this product contains parts that can be hazardous to small children. This product should be assembled by an adult.



Adult Supervision

This product is to be used under the supervision of an adult.



Indoor Use Only

This product is intended for indoor use only. To reduce the risk of fire or electric shock, do not expose this product to rain or moisture. The internal components are not sealed from the environment.



Powerbar Specifications

Read your powerbar's electrical specifications. Only plug in devices that are approved for use with this powerbar. Connect the supplied power bar directly to a wall outlet. **Do not connect to another power bar or use an extension cord.** Unplug when not in use.

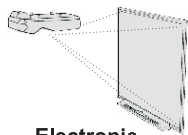

Electronic Equipment

Read the electrical specifications of any electronic equipment you are using with your Copernicus products. Failure to read these specifications and follow their instructions could result in damage to your equipment or personal injury.



Cable Trip Hazard

Ensure that any cables extending across the floor to your product are properly bundled and marked to avoid tripping or falling which may lead to personal injury.



Electrical Shock

Do not install or use the electrical components of this unit during a lightning storm.



Climb Hazard

Do not climb on, hang from or suspend objects from any components of your product unless otherwise specified.



# 3D Printer Cart - Parts

**Before beginning, you should have:**

Additional tools required:

Screwdriver

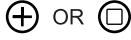

Adjustable wrench x1

## Contents - Box 1

4" Caster With Brake & Safety Pinch Point Cover  
**2x** (41013)



4" Caster No Brakes  
**2x** (41014)



Double Sided Foam Tape  
**2x** (700012)



Spool Arm Holder Right  
**1x** (51089)



Side Frame  
**2x** (51087)



Middle Frame  
**1x** (51088)

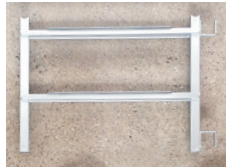

Spool Arm Holder Left  
**1x** (51089)



Handle  
**1x** (33093)



Top Drawer Stretcher Left & Right  
**2x** (33094)

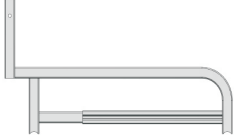

Stretcher  
**2x** (33092)



Power Strip  
**1x** (25515)



Spool Holder  
**1x** (33095)



In Box 1

Hardware  
Actual Size

- (A) 1/4" x 1-3/4" Bolt (43007) **16x**
- (B) 1/4"-20 x 1 1/4" Bolt (430043) **4x**
- (C) M6 x 19mm Screw (43219) **2x** Caster Wrench (Not to Scale) **1x**
- (D) 10-24" x 7/8" Screw (430137) **2x**
- (E) M6 Barrel Nut (43272) **2x**
- (F) 10-24 Lock Nut (430165) **2x**
- (G) 1/4" Keps Nut (4301621) **4x**
- (H) 1/4" Lock Washer (43010) **16x**
- (I) M8 Washer (43274) **2x**
- (J) Caster Lock Washer (43010211) **4x**
- Allen Key (Not to Scale) (43281) **2x**

## TD5000 - BOX 2

Laptop Tray (drawer slides attached)  
**1x** (32060)

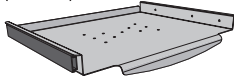

Open Tub **4x** (CC4068-B) 10 lbs Weight Limit

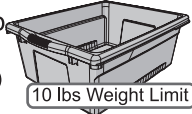

Tiny Tub **1x** (CC4072-G)



Printer Table **1x** (32061)



Really Big Tub **1x** (CC4073-B) 15 lbs Weight Limit



Really Big Tub Frame **1x** (31091)



OR

## TD5001 - BOX 2

Laptop Tray (drawer slides attached)  
**1x** (32060)

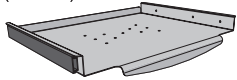

Open Tub **2x** (CC4068) 10 lbs Weight Limit

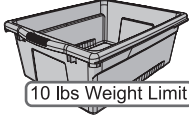

Tiny Tub **1x** (CC4072)



Really Big Tub **1x** (CC4073) 15 lbs Weight Limit

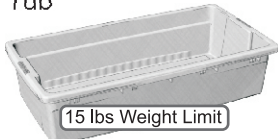

Printer Table **1x** (32061) 50 lbs Weight Limit

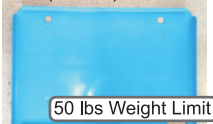

Really Big Tub Frame **1x** (31091)



## TD5001 - BOX 3

Tech Tub™ **1x** (TEC57)

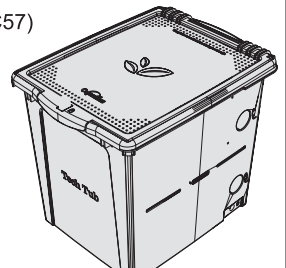

# Tips for Assembly - Using this Manual



2 Person

## Watch for These Helpful Symbols

- This symbol denotes a 2 Person Task. For safety, please ensure that there are two people working on steps displaying this symbol



- Watch for this symbol throughout the Assembly Instructions. Wherever you see it, pay close attention. The symbol denotes a step needing extra attention to ensure it is done correctly.



- The Star symbol highlights an advisory note

## Before You Begin



- Layout and identify all of the included parts
- The hardware has been packed by size
- Read the assembly instructions over once to familiarize yourself with them
- Please note that in its unassembled state, this product contains parts that can be a hazard to small children; it should be assembled by an adult.

## As You Assemble the Unit



- Follow the steps in sequence
- Before beginning each step, find the part(s) that you need for that step
- Pay attention to the labeling on the parts, they are there to help direct you at certain stages
- The title of each step states what you will be doing. Review the text and the pictures as you build the unit.

5  
Year

Frame  
Warranty

Life  
Time

Tub  
Warranty

## Validate Your Warranty On-Line

To validate your warranty submit the ON-LINE form at [www.copernicused.com](http://www.copernicused.com)

“The beautiful thing about learning is that no one can take it away from you.” - B. B. King



# 3D Printer Cart



## Assembly Guide TD5000\_TD5001\_2015\_A

Check out our other products online at  
[www.copernicused.com](http://www.copernicused.com)

For assistance, please contact us:

**1-800-267-8494**

Email [info@copernicused.com](mailto:info@copernicused.com)

**Have your packing slip ready for reference**

Dear Educator,

Thank you for purchasing one of our products.

I hope the assembly of your 3D Printer Cart went well.

If you have any questions, or concerns, or ideas for how we can improve, please call us at 1-800-267-8494, where someone will be happy to help.

Enjoy using your new product, and happy teaching,

*Jim Phillips*  
President

Quality schools are the result of quality teachers going above and beyond the call of duty.

VICKI CARUANA

## Customer Service - FAQ's



### For missing parts and other issues regarding the cart:

- The laptop tray won't slide out smoothly.
- Ho to adjust the spool holders.

*Please call Copernicus Customer Service, where we will be happy to help.  
1-800-267-8494. Monday - Friday 8:30am - 4:30 pm EST.*

*OR*

*Email our Tech Support Service at [info@copernicused.com](mailto:info@copernicused.com)*

**Need Tech Support?  
Have a Question?**



Email our Tech Support Service



1

Actual Size:



(A) 2x



(H) 2x

You will need: (Not to Scale)



Side Frame  
1x



Stretcher  
2x

### Attach Stretchers to Side Frame

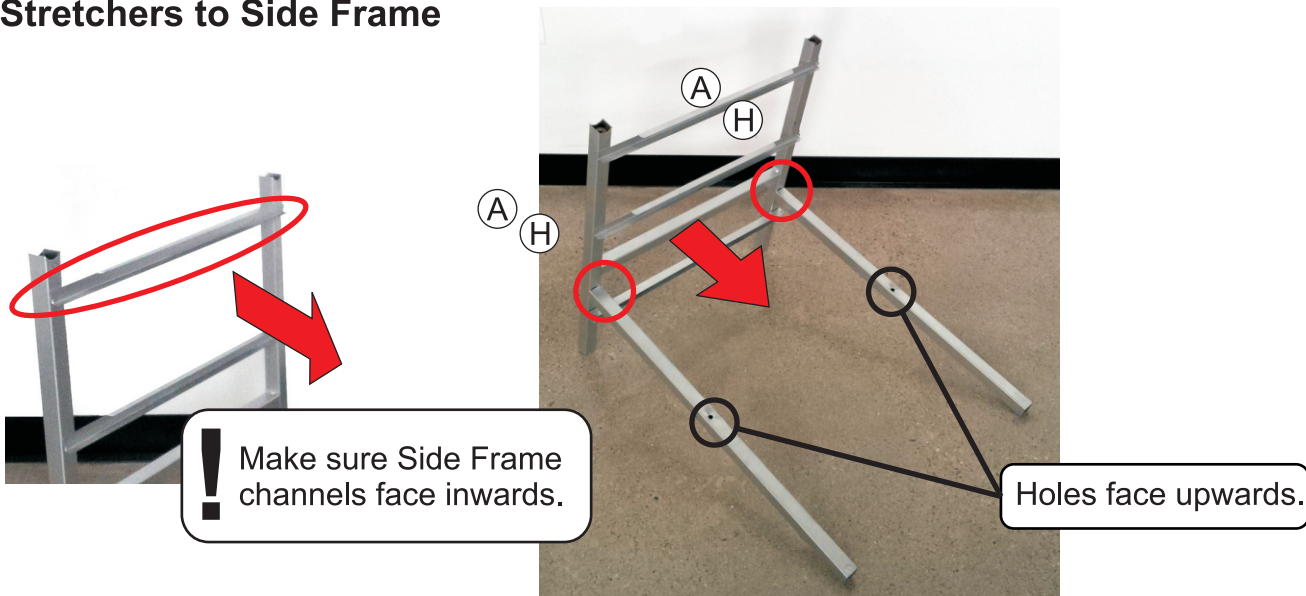

2

Actual Size:



(A) 2x



(H) 2x

You will need: (Not to Scale)



Side Frame  
1x

### Attach other Side Frame

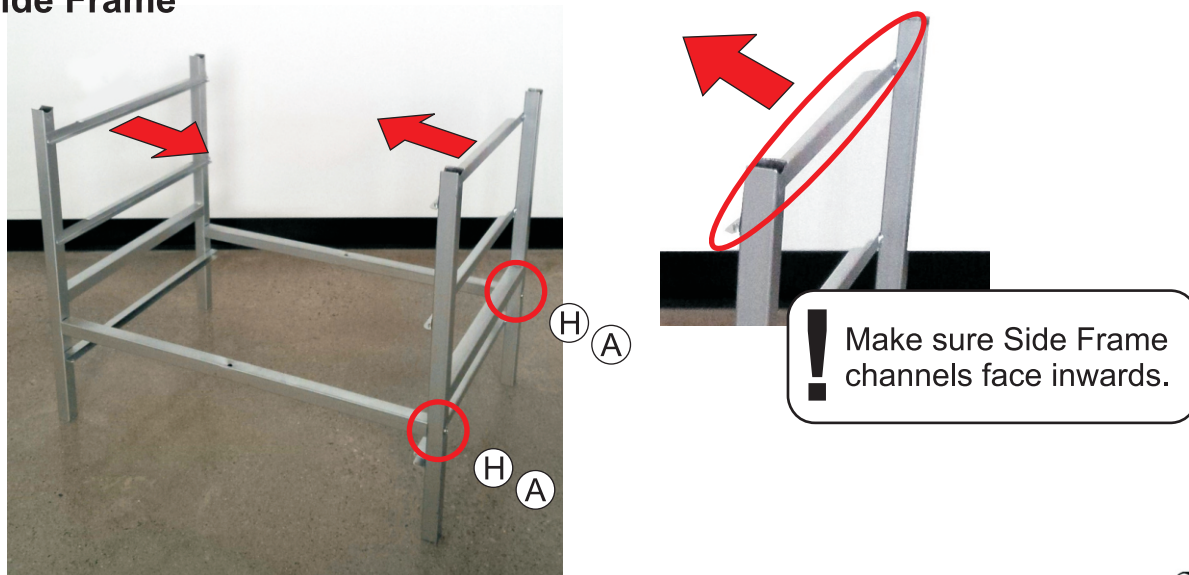

3

Actual Size:



(A) 2x



(H) 2x

You will need: (Not to Scale)



Middle Frame  
1x

### Attach Middle Frame

Position main frame upside down to attach Middle Frame.

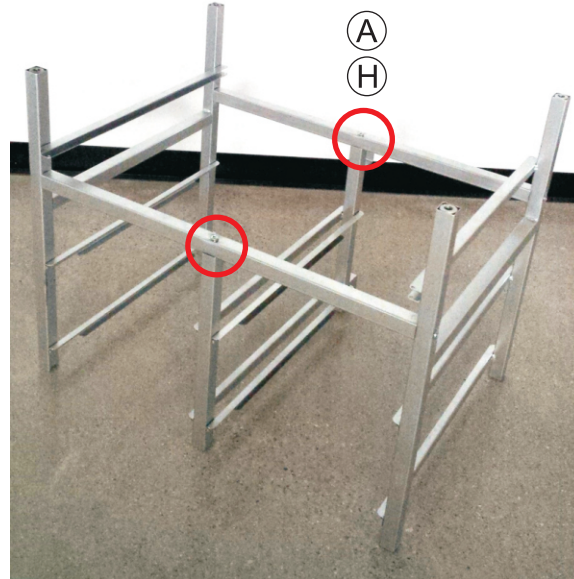

4

Actual Size:

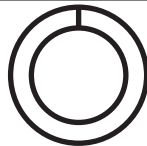

(J) 4x

You will need: (Not to Scale)

4" Caster With Brake & Safety Pinch Point Cover  
2x (41013)



4" Caster without Brakes  
2x (41014)



Caster Wrench  
1x



### Install Casters

Place lock nut over threaded post of caster. Locking casters are installed on front of cart, opposite of cable wrap. Non-locking casters installed back of cart, same side as cable wrap.

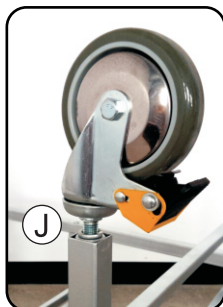

Locking Casters:  
Use Caster Wrench to tighten.

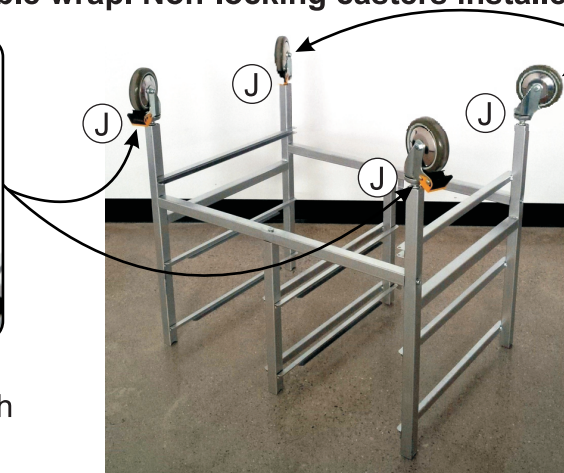

Non-Locking Casters:  
Use Caster Wrench to tighten.

**PLEASE KEEP WRENCH WITH UNIT.**  
! Casters need to be tightened every 6 months for proper maintenance.



5

Actual Size:



D 2x



F 2x

You will need: (Not to Scale)

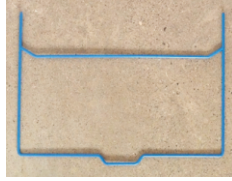

Really Big Tub Frame  
1x



Adjustable wrench x1

### Install Really Big Tub Frame

Slide Really Big Tub frame into cart frame opposite of cable hooks on Middle Frame and install safety bolts

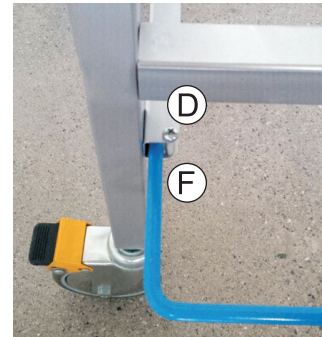
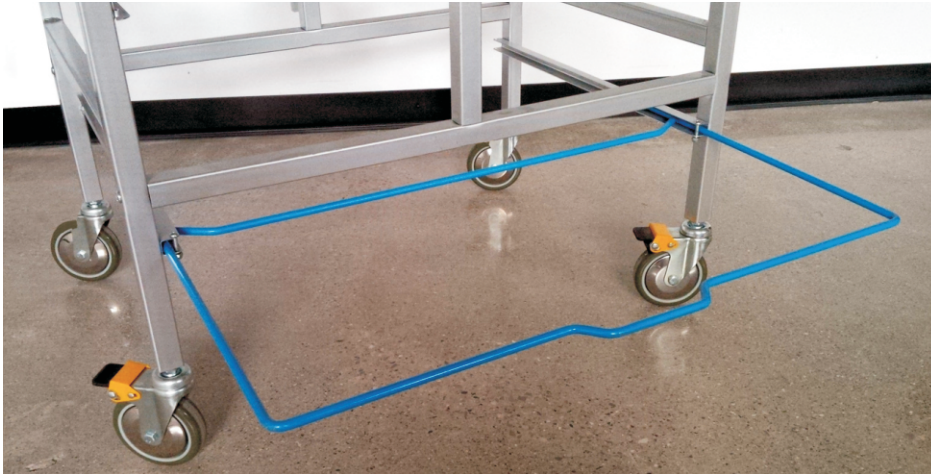

! Push frame all the way in & then install bolts.  
! Do not over tighten.

6

Actual Size:



A 6x



H 6x

You will need: (Not to Scale)



Handle  
1x

### Attach Handle

Note orientation of handle in diagram.

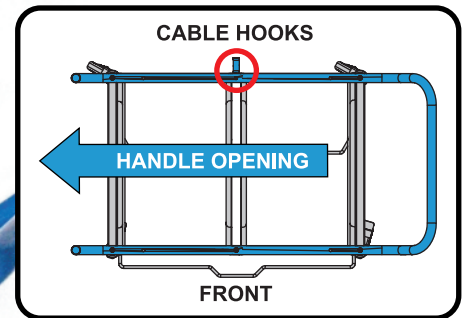
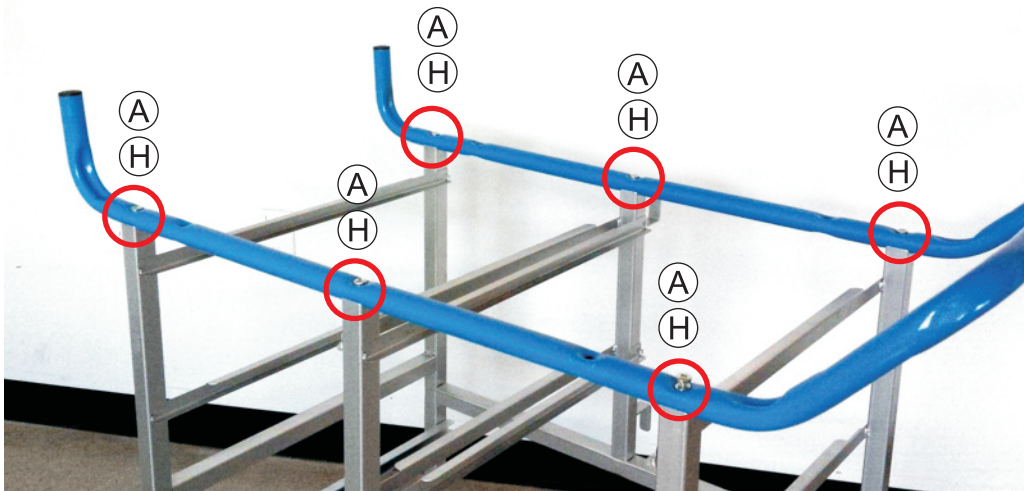

7

Actual Size:



(A) 4x



(H) 4x

You will need: (Not to Scale)



Top Drawer Stretcher  
2x

### Attach Top Drawer Stretchers

Do not fully tighten hardware until the end of Step 8.

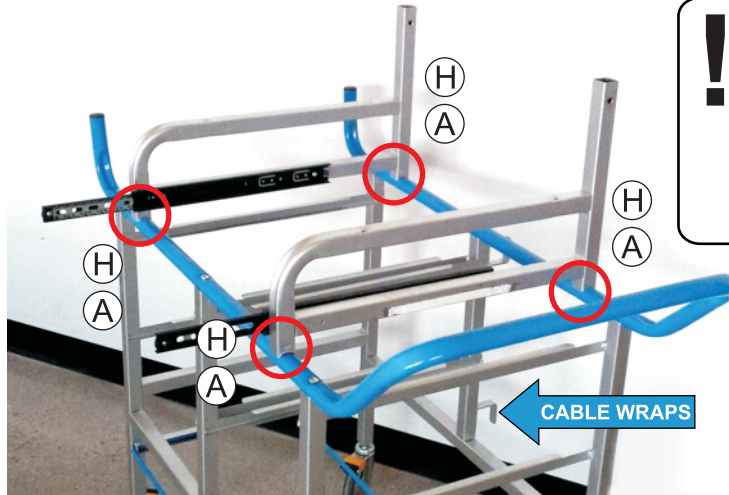

! Note channels face inward

! Note orientation of Top Drawer Stretchers. Drawer Slides slide out towards the front, opposite to the cable hooks on the back.

8

Actual Size:

You will need: (Not to Scale)

Laptop Tray  
(drawer slides attached)  
1x

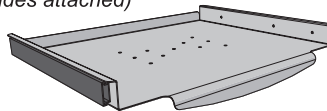

### Install Laptop Tray

Completely slide Laptop Tray into drawer slides. Tighten hardware from Step 7.



! Pull the tray out slowly to ensure that the drawer has been fully locked in.



9

Actual Size:



B 4x



G 4x

You will need: (Not to Scale)

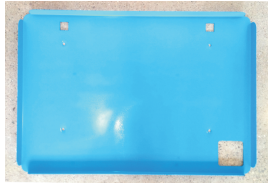

Printer Table  
1x

### Install Printer Table

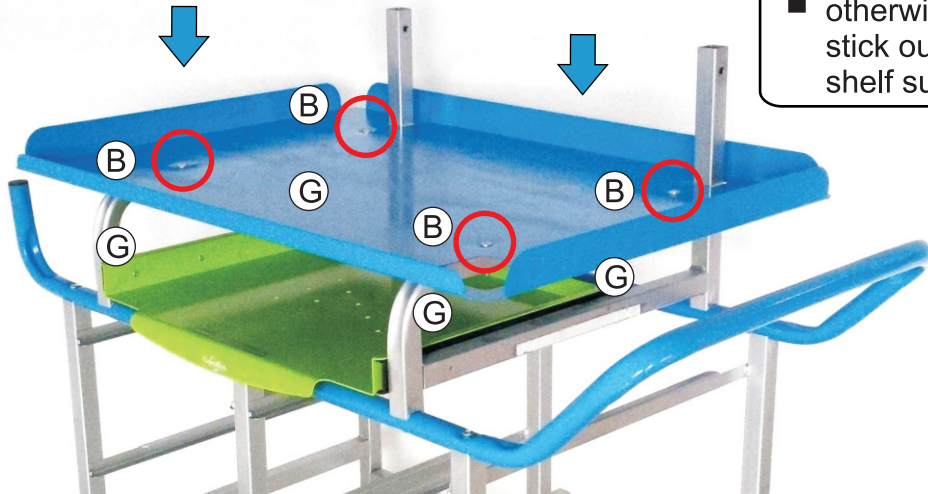

**!** Tighten screws until flush with shelf, otherwise they will stick out above printer shelf surface.

10

Actual Size:

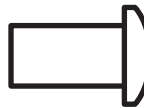

E 2x



C 2x



I 2x

You will need: (Not to Scale)



Spool Holder  
1x



Spool Arm Holder  
2x

### Install Spool Holder Arms

**★** Spool holder rests in place.

**!** Magnets face outward

**!** Spool Holder Arms are adjustable for different printers. Choose height where spools will not rest on printer body.

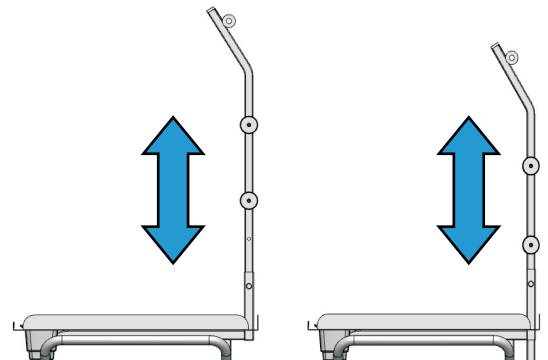
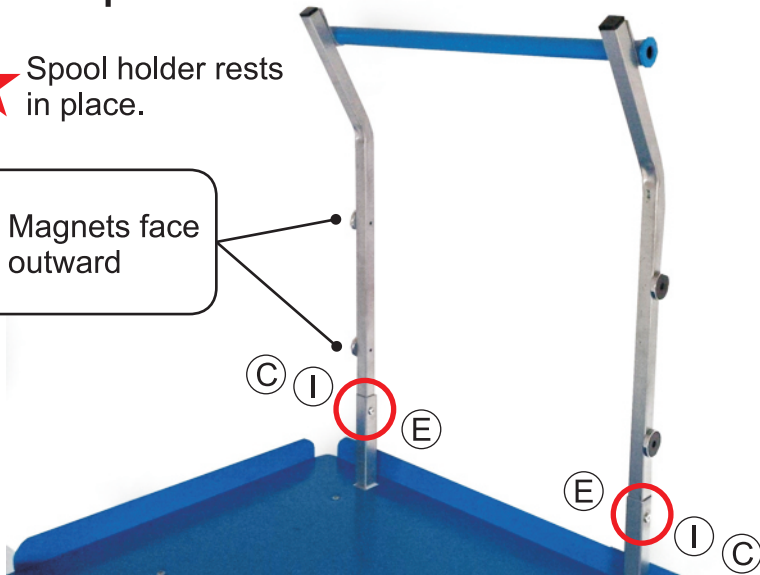

11

Actual Size:

You will need: (Not to Scale)

Tiny Tub  
1x  
(CC4072)



### Install Tiny Tub in Holder



12

Actual Size:

You will need: (Not to Scale)

Power Strip  
1x  
(25515)

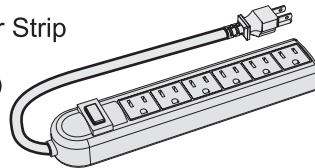

Double Sided  
Foam Tape  
2x (700012)

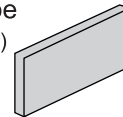

### Attach Power Strip

Attach Power Strip to the cart by using the supplied double sided tape. Install on the same side as the handle. Install on the stretcher shown below. Wrap cord around hooks on back of unit.

1

Apply Double Sided Tape Here

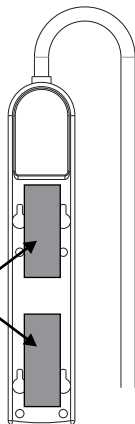

2



3



You will need: (Not to Scale)

TD5000      Open Tub      Really Big Tub  
 4x            10 lbs Weight Limit      1x            15 lbs Weight Limit

OR

TD5001      Open Tub      Really Big Tub      Tech Tub™  
 4x            10 lbs Weight Limit      1x            15 lbs Weight Limit      1x (TEC57)

Install Tubs

TD5000

Printer and accessories not included.

OR

TD5001

Printer and accessories not included.



