

**BIBLIOTHÈQUE 71"H HOLLOW-CORE NOIR / GRIS
BLACK / GREY HOLLOW-CORE 71"H BOOKCASE**

**INSTRUCTIONS D'ASSEMBLAGE
ASSEMBLY INSTRUCTIONS**





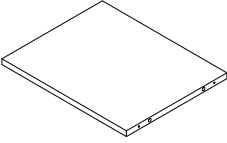
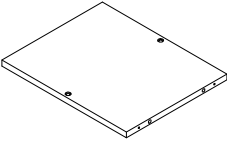
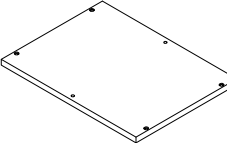
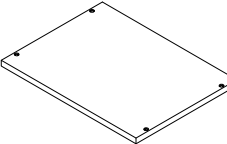
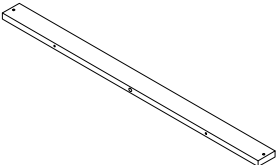
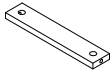
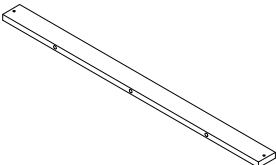
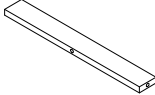
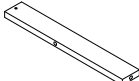

**POUR DE L'ASSISTANCE OU POUR COMMANDER
DES PIÈCES CONTACTEZ NOTRE DÉPARTEMENT
DE SERVICE À LA CLIENTÈLE.**

**FOR ASSISTANCE OR TO ORDER PARTS
CONTACT OUR CUSTOMER SERVICE DEPARTMENT**

IDENTIFICATION DES PIÈCES
PARTS IDENTIFICATION

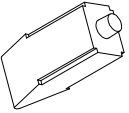
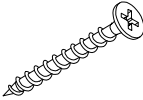
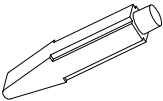
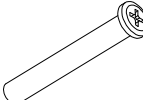
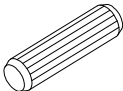
1		PANNEAU CÔTÉ SIDE PANEL	8MCX 8PCS
2		PANNEAU DE DIVISION DIVIDER PANEL	8MCX 8PCS
3		PLAQUE TRANSVERSALE CROSS PANEL	14MCX 14PCS
4		PANNEAU DU DESSUS TOP PANEL	2MCX 2PCS
5		PLAQUE TRANSVERSALE CROSS BRACE	2MCX 2PCS
6		PANNEAU DE DIVISION DIVIDER PANEL	9MCX 9PCS
7		PANNEAU DE DIVISION DIVIDER PANEL	6MCX 6PCS
8		PANNEAU DE DIVISION DIVIDER PANEL	6MCX 6PCS
9		PANNEAU DE DIVISION DIVIDER PANEL	2MCX 2PCS

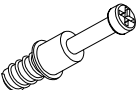
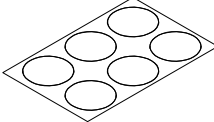
IDENTIFICATION DES PIÈCES DE MONTAGE HARDWARE IDENTIFICATION

A		COLLE/GLUE(40g)	1MC / PC	F		38mm	68MCX / PCS
B		COLLE/GLUE(15g)	1MC / PC	G		47mm	20MCX / PCS
C		∅8 x 30mm	78MCX / PCS	H		42mm	20MCX / PCS
D		35mm	18MCX / PCS	I		∅20mm	11MCX / PCS
E		∅15x12mm	18MCX / PCS				

ÉTAPE / STEP 1

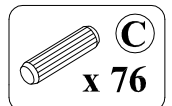

INCORRECT CORRECT

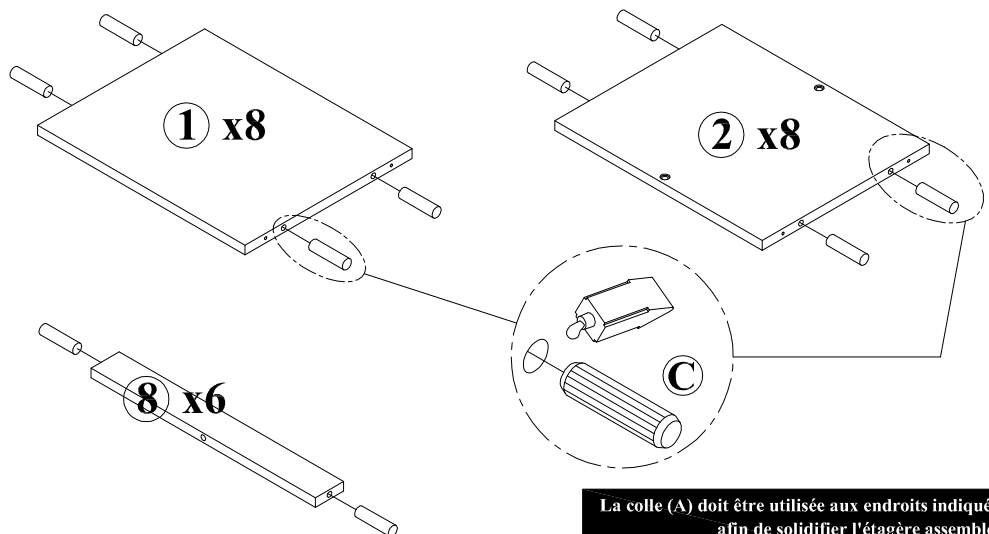
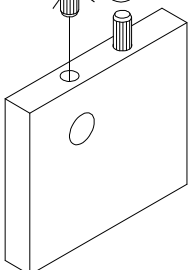

La colle (A) doit être utilisée aux endroits indiqués afin de solidifier l'étagère assemblée.
The Glue (A) should be used in the indicated locations to help solidify the assembled unit.

ÉTAPE / STEP 2

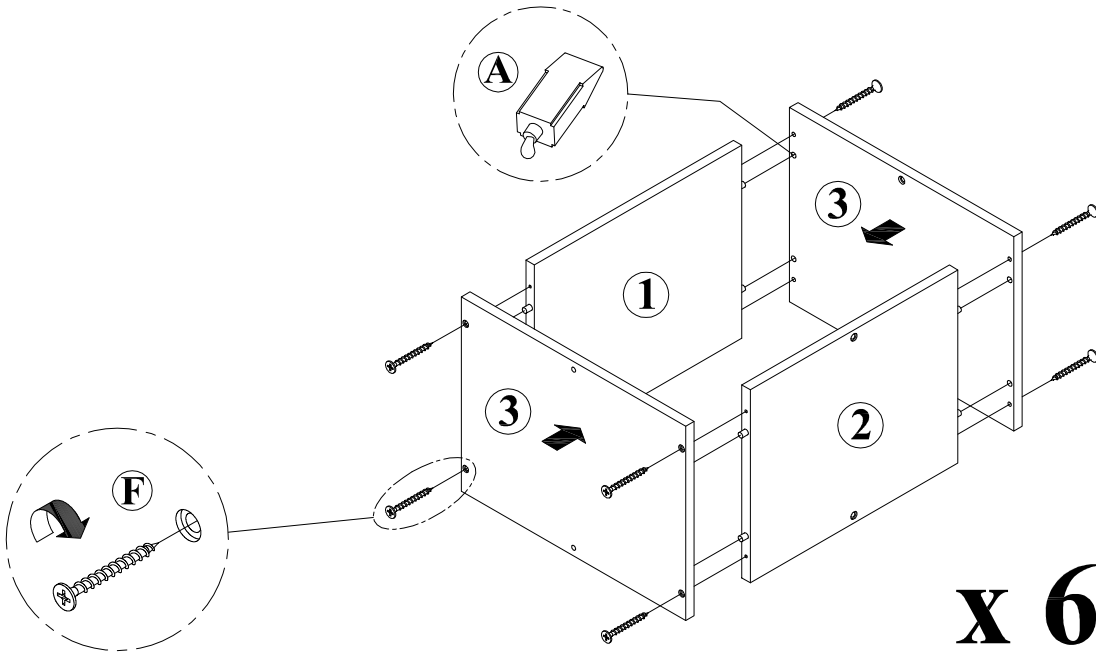
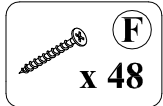

x 6

La colle (A) doit être utilisée aux endroits indiqués
afin de solidifier l'étagère assemblée.
The Glue (A) should be used in the indicated
locations to help solidify the assembled unit.

ÉTAPE / STEP 3

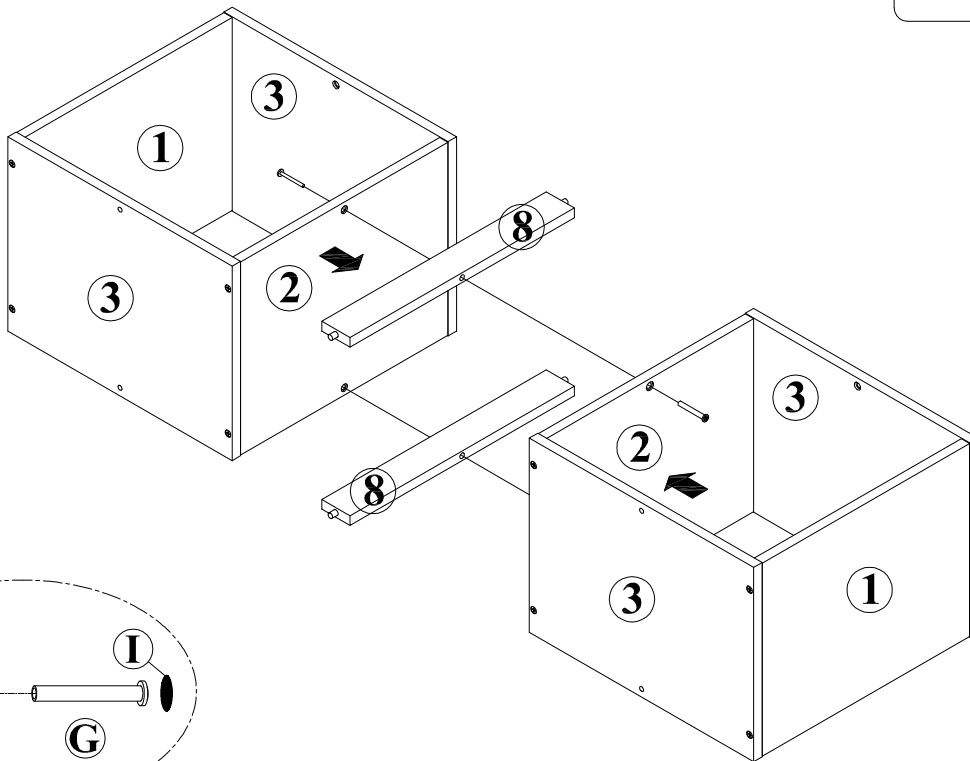
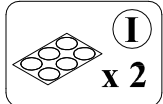
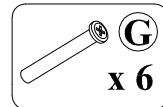

x 3

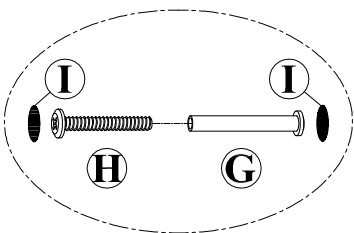

ÉTAPE / STEP 4

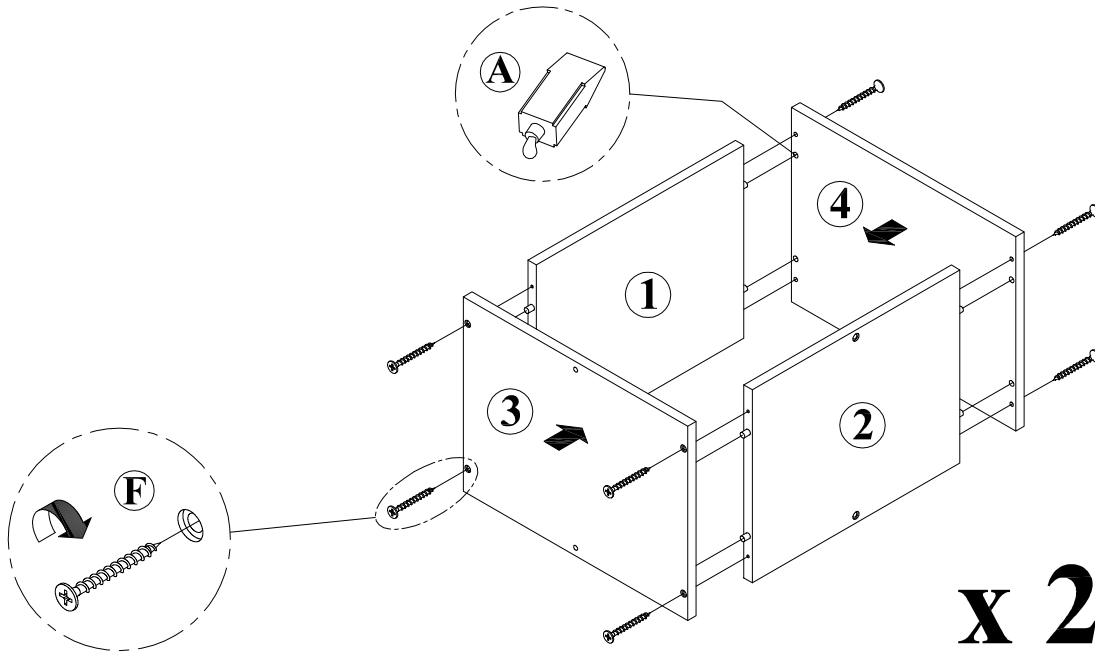
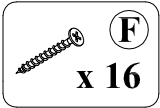

La colle (A) doit être utilisée aux endroits indiqués afin de solidifier l'étagère assemblée.
The Glue (A) should be used in the indicated locations to help solidify the assembled unit.

ÉTAPE / STEP 5

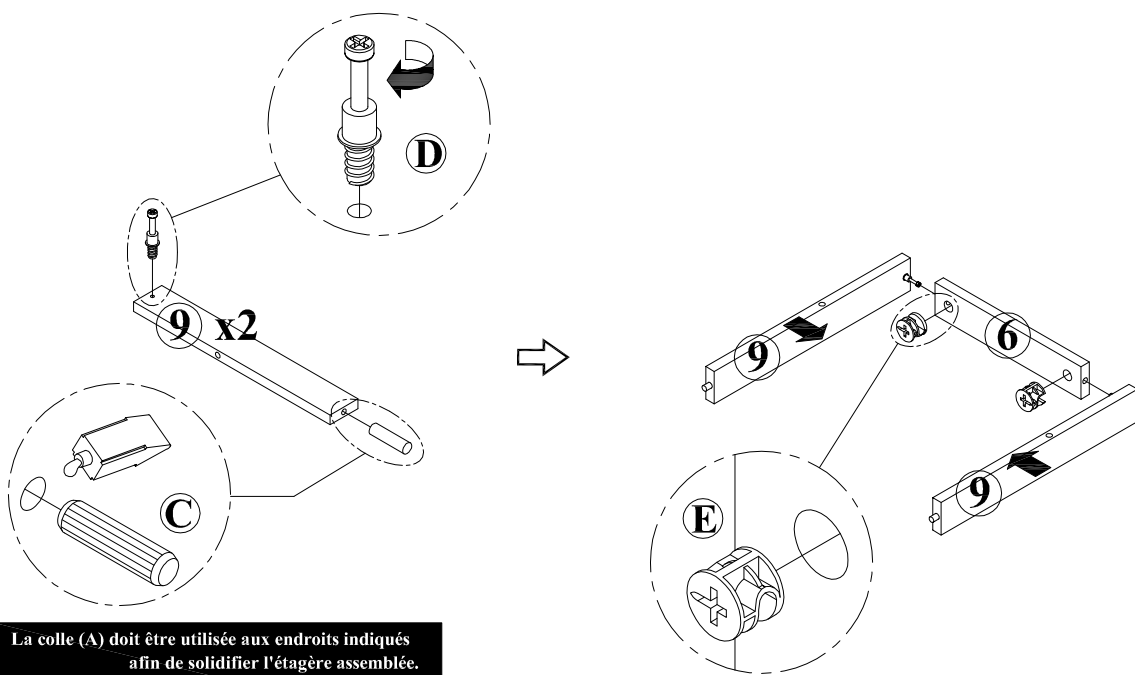
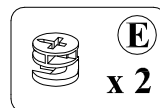
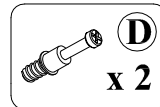
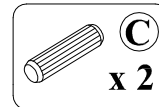

La colle (A) doit être utilisée aux endroits indiqués afin de solidifier l'étagère assemblée.
The Glue (A) should be used in the indicated locations to help solidify the assembled unit.

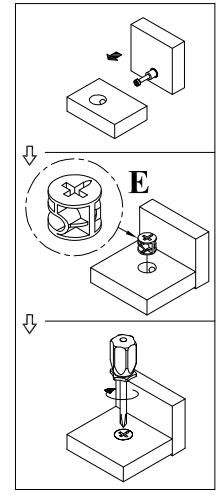

ÉTAPE / STEP 6

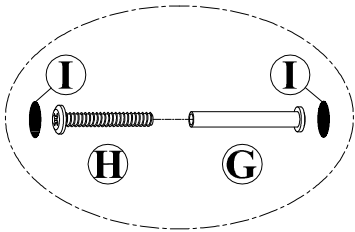
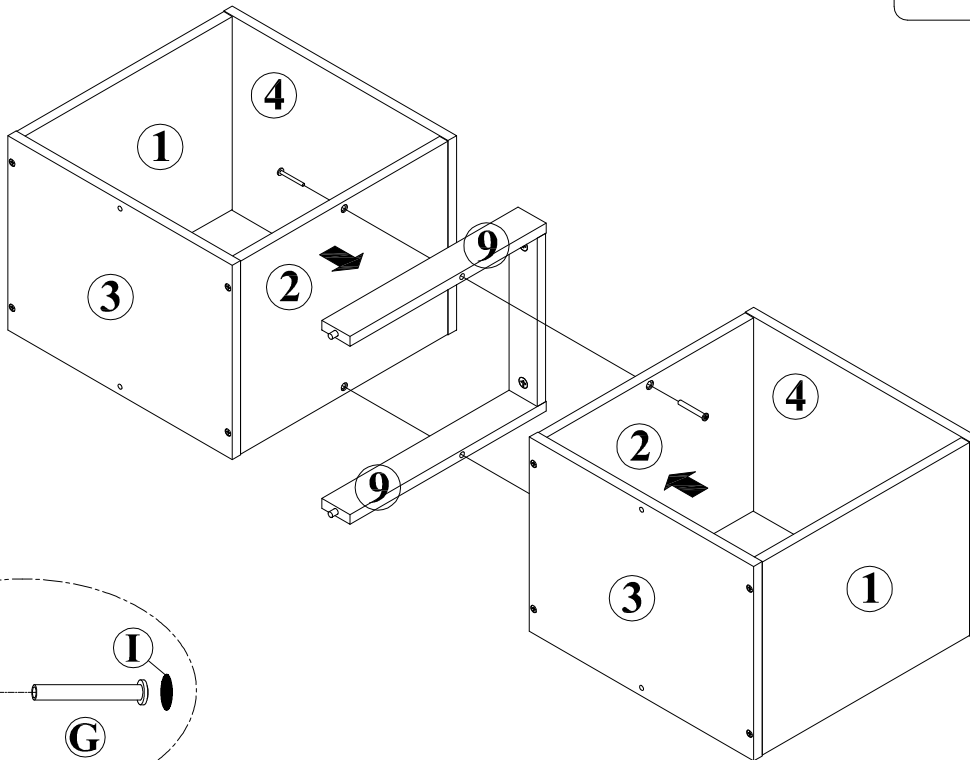
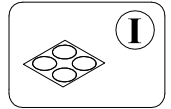
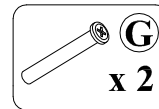

ÉTAPE / STEP 7

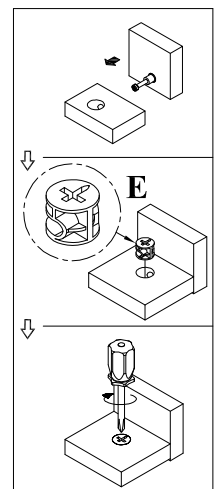
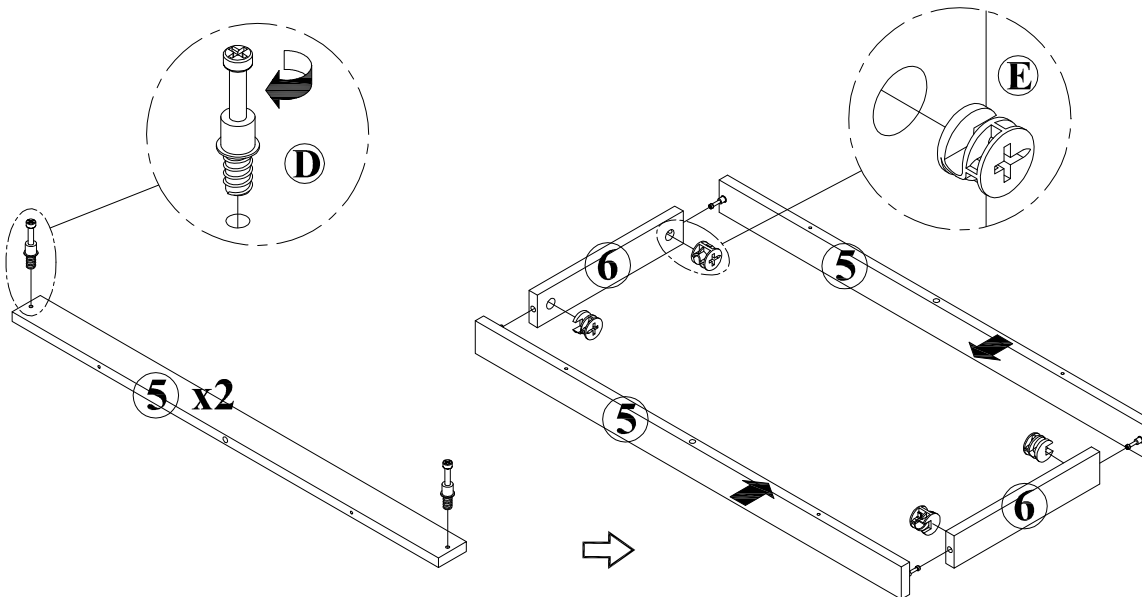
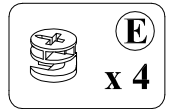
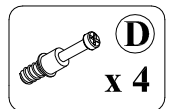

ÉTAPE / STEP 8

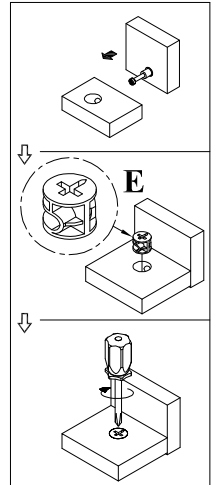
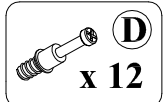
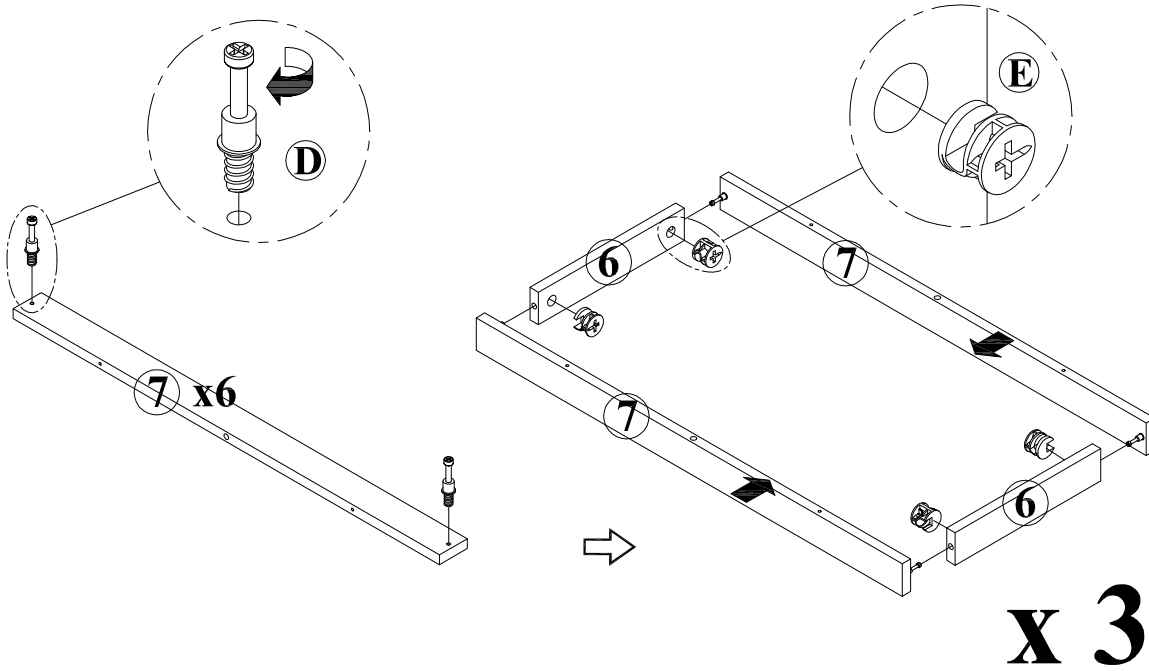

ÉTAPE / STEP 9

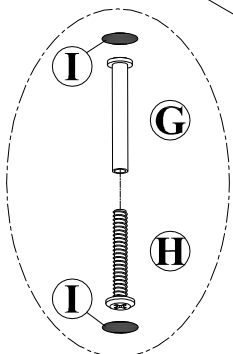
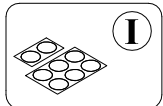
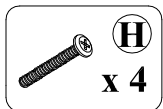
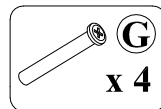
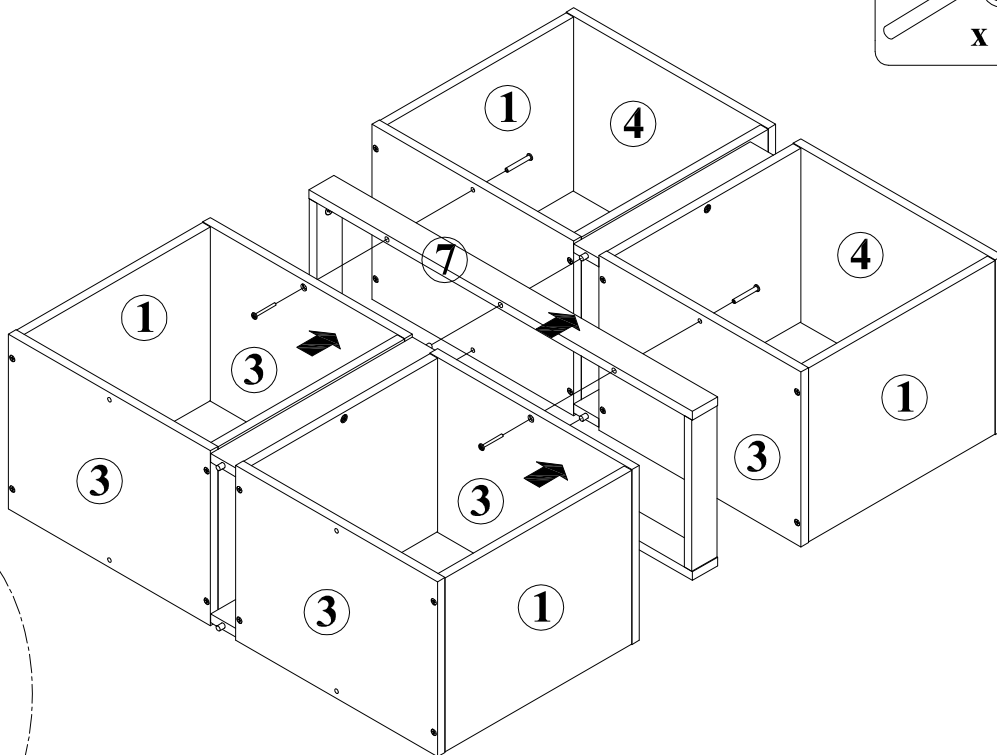

La colle (A) doit être utilisée aux endroits indiqués afin de solidifier l'étagère assemblée.
The Glue (A) should be used in the indicated locations to help solidify the assembled unit.

ÉTAPE / STEP 10

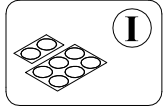
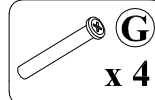
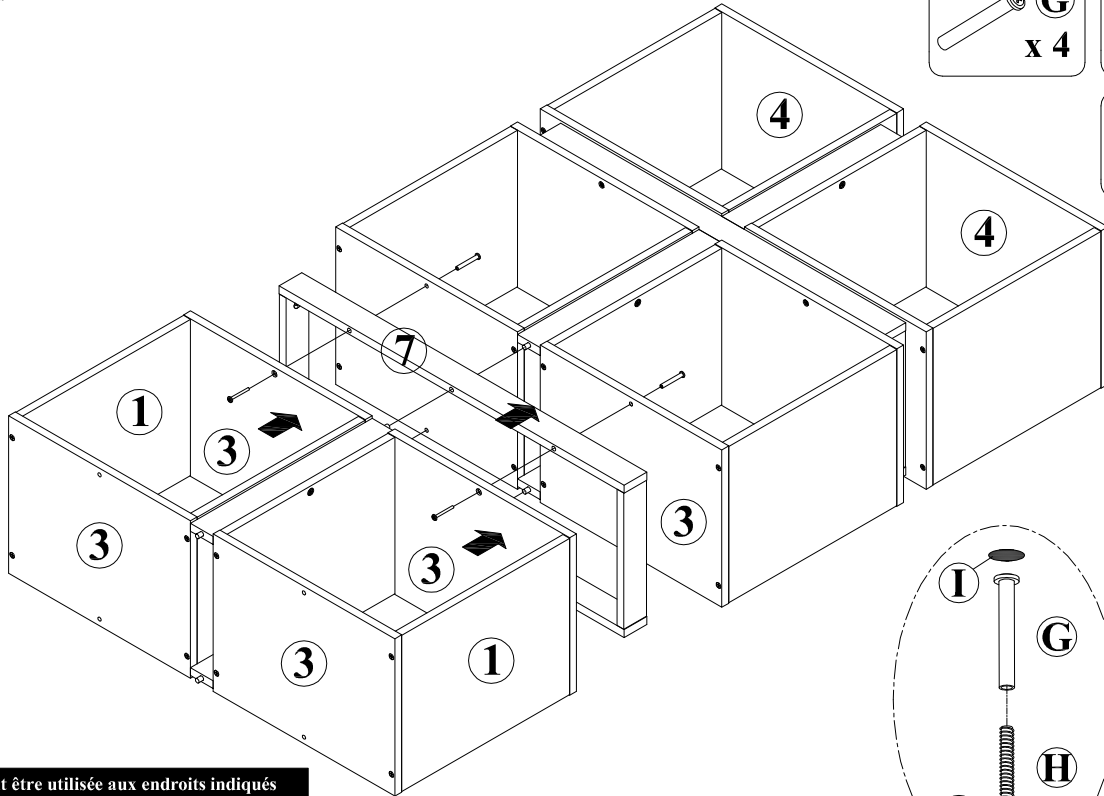

La colle (A) doit être utilisée aux endroits indiqués
afin de solidifier l'étagère assemblée.
The Glue (A) should be used in the indicated
locations to help solidify the assembled unit.

ÉTAPE / STEP 11

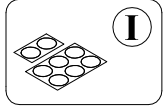
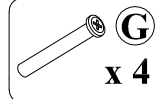
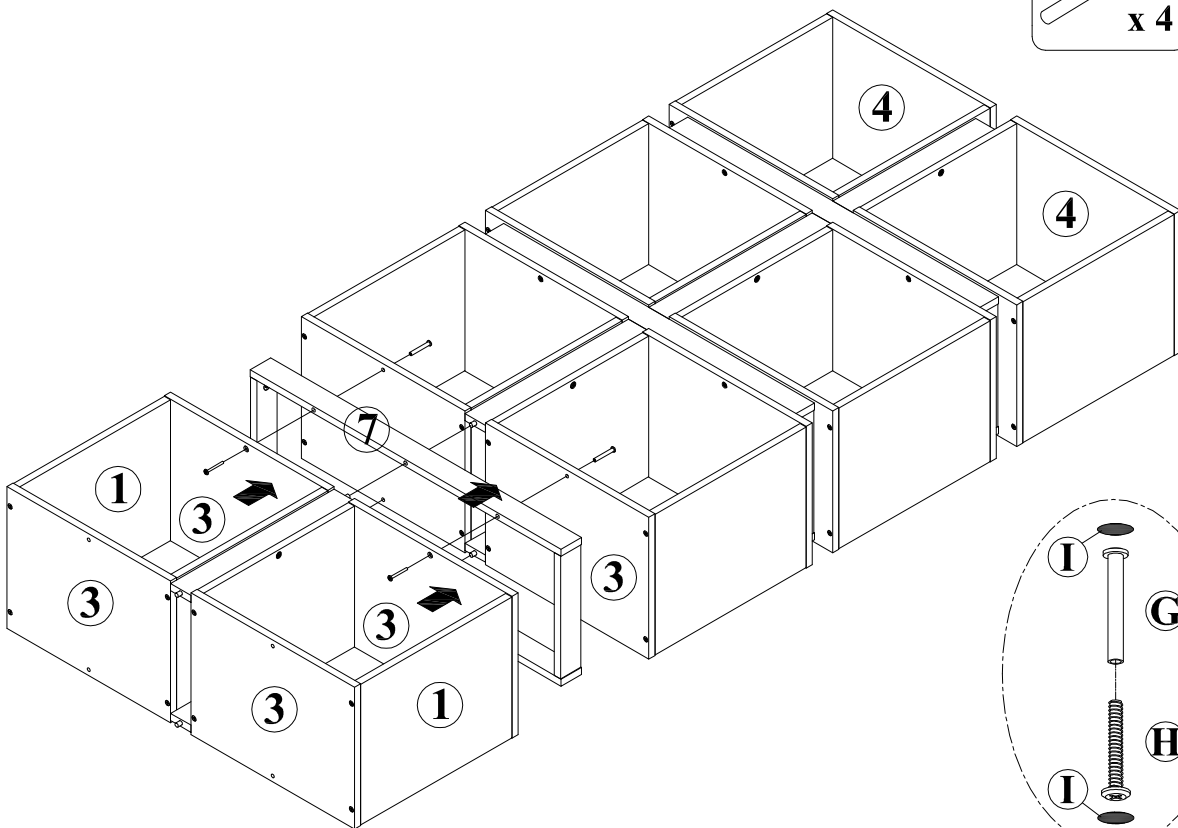

ÉTAPE / STEP 12

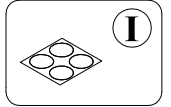
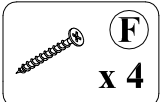
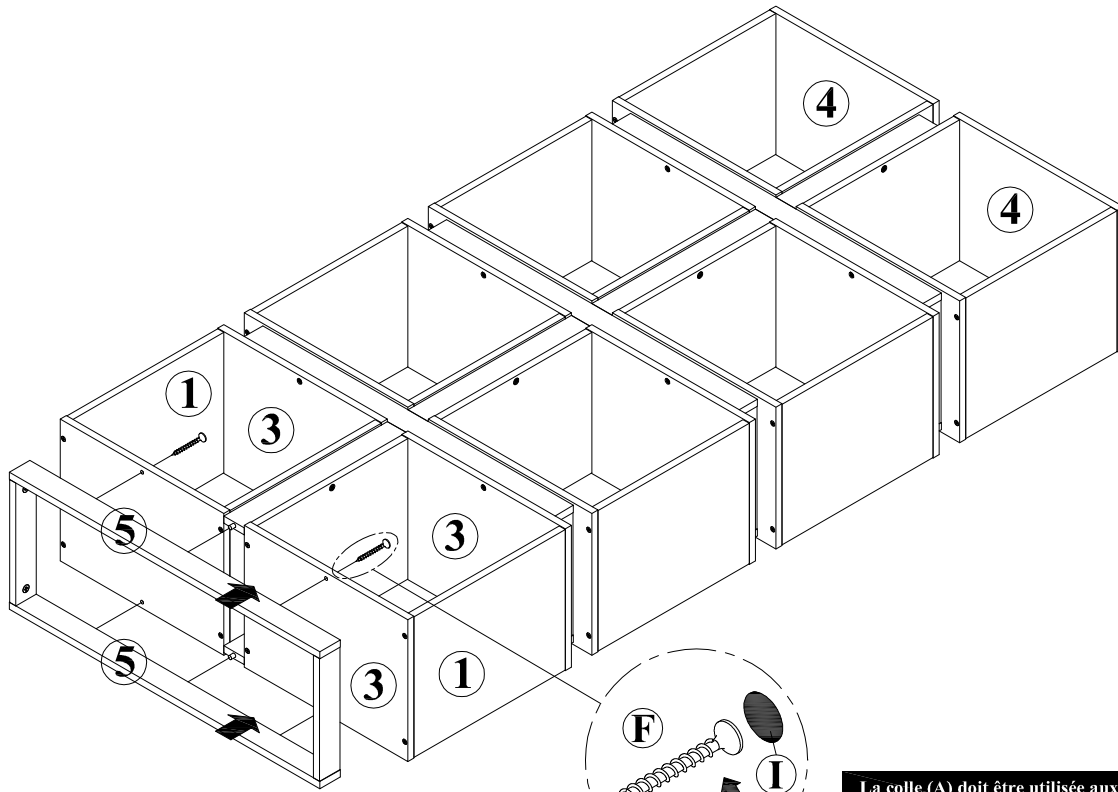

La colle (A) doit être utilisée aux endroits indiqués
afin de solidifier l'étagère assemblée.
The Glue (A) should be used in the indicated
locations to help solidify the assembled unit.

ÉTAPE / STEP 13

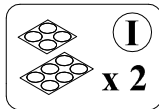

TERMINER / FINISH

