

# ASSEMBLY INSTRUCTIONS

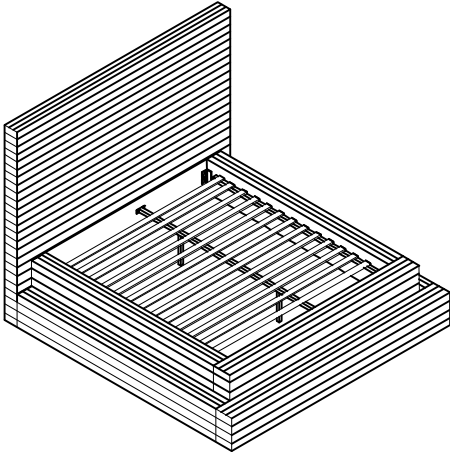

**+ Do Not Use Power Tools**



**+ Suggested Adults**

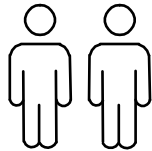

**NOTE:**

- 1 Read instructions cover to cover.
- 2 Save all packaging until assembly is completed.

## 1 IMPORTANT SAFETY INFORMATION

Do not assemble the product if any of the following parts arrived damaged:

- Part # ③/④-Side Rails
- Part # ⑤ -Center Support Bar
- Part # ⑥ -Support Legs
- Part # ⑧-Slats joint

## 2 IMPORTANT ASSEMBLY INFORMATION

Assembly Step ③ Ensure the side rail bracket is fully hooked onto bolt C closely threaded with both washers on the OUTSIDE of the bracket first, then proceed to fully tightening all 4 corners.

## + Parts Included

① Head Board (1pc)

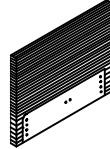

② Inside Foot Board (1pc)

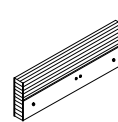

③ Inside Side Rails (2pcs)

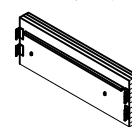

④ outside Side Rails (2pcs)

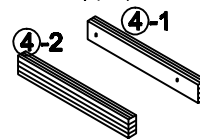

⑤ Center Support Bar (1pc)



⑥ Support Legs (2pcs)



⑦ outside Foot Board (1pc)

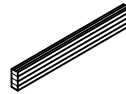

⑧ Slats joint (1set=12pcs)

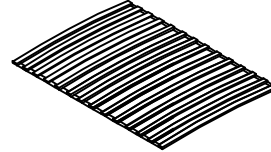

\*Slats come packed in the bottom of headboard carton.

## + Hardware Included

A Bolt M8\*30mm (8pcs)



B Bolt M8\*200mm (6pcs)



C Bolt M8\*40mm (16pcs)



D Spring Washer (16pcs)



E Flat Washer  $\phi$ 20 (24pcs)



F M8 Allen Key (1pc)



G Flat Washer  $\phi$ 22 (6pcs)



I Nut M8\*13mm (10pcs)



J Spanner (1pc)



# ASSEMBLY INSTRUCTIONS

